

## Buffered H-Bridge

### DESCRIPTION

The Si9986 is an integrated, buffered H-bridge with TTL compatible inputs and the capability of delivering a continuous 1.0 A at  $V_{DD} = 12\text{ V}$  (room temperature) at switching rates up to 200 kHz. Internal logic prevents the upper and lower outputs of either half-bridge from being turned on simultaneously. Unique input codes allow both outputs to be forced low (for braking) or forced to a high impedance level.

The Si9986 is available in both standard and lead (Pb)-free, 8-pin SOIC packages, specified to operate over a voltage range of 3.8 V to 13.2 V, and the commercial temperature range of 0 to 70 °C (C suffix) and the industrial temperature range of - 40 to 85 °C (D suffix).

### FEATURES

- 1.0 A H-Bridge
- 200 kHz Switching Rate
- Shoot-Through Limited
- TTL Compatible Inputs
- 3.8 to 13.2 V Operating Range
- Surface Mount Packaging



**RoHS\***  
COMPLIANT

### APPLICATIONS

- VCM Driver
- Brushed Motor Driver
- Stepper Motor Driver
- Power Converter
- Optical Disk Drives
- Power Supplies
- High Performance Servo

### FUNCTIONAL BLOCK DIAGRAM, PIN CONFIGURATION AND TRUTH TABLE

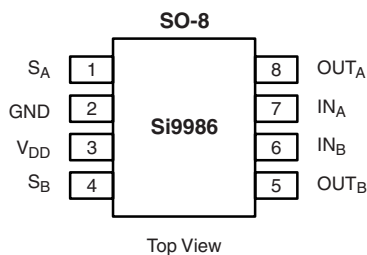

TRUTH TABLE			
IN <sub>A</sub>	IN <sub>B</sub>	OUT <sub>A</sub>	OUT <sub>B</sub>
1	0	1	0
0	1	0	1
0	0	0	0
1	1	HiZ	HiZ

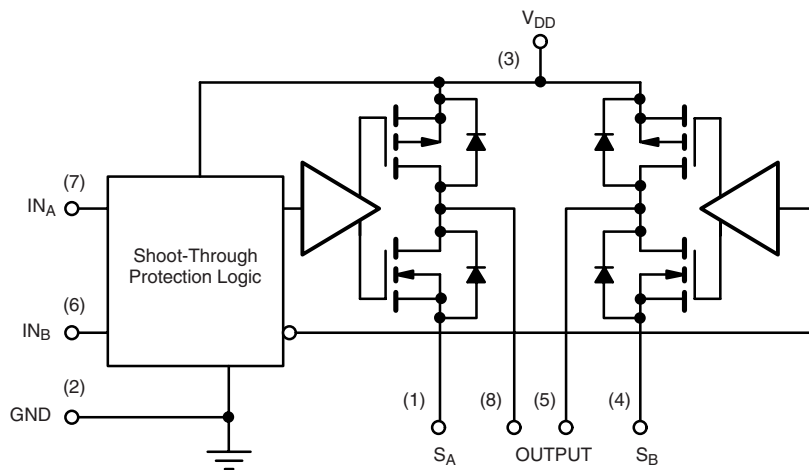

PIN DESCRIPTION		
Pin Number	Name	Function
1	S <sub>A</sub>	Source of the low-side MOSFET on bridge arm A
2	GND	Ground
3	V <sub>DD</sub>	IC power supply
4	S <sub>B</sub>	Source of the low-side MOSFET on bridge arm B
5	OUT <sub>B</sub>	Center tap of bridge arm B. Connects to one end of the load
6	IN <sub>B</sub>	Input signal to control bridge arm B
7	IN <sub>A</sub>	Input signal to control bridge arm A
8	OUT <sub>A</sub>	Center tap of bridge arm A. Connects to the other end of the load

ORDERING INFORMATION		
Part Number	Temperature Range	Package
Si9986CY-T1	0 to 70 °C	Tape and Reel
Si9986DY-T1	- 40 to 85 °C	
Si9986CY-T1-E3	0 to 70 °C	Lead (Pb)-free Tape and Reel
Si9986DY-T1-E3	- 40 to 85 °C	
Si9986CY	0 to 70 °C	Bulk (tubes)
Si9986DY	- 40 to 85 °C	

\* Pb containing terminations are not RoHS compliant, exemptions may apply.

ABSOLUTE MAXIMUM RATINGS <sup>a</sup>			
Parameter		Limit	Unit
Voltage on any Pin with Respect to Ground		- 0.3 to $V_{DD} + 0.3$	V
Voltage on Pins 5, 8 with Respect to GND		- 1 to $V_{DD} + 1$	
Voltage on Pins 1, 4		- 0.3 to $GND + 1$	
Peak Output Current		1.5	A
Storage Temperature		- 65 to 150	°C
Maximum Junction Temperature ( $T_J$ )		150	
Maximum $V_{DD}$		15	V
Power Dissipation <sup>b</sup>		1	W
$\Theta_{JA}$		100	°C/W
Operating Temperature Range		Si9986CY	0 to 70
		Si9986DY	- 45 to 85

## Notes:

- a. Device Mounted with all leads soldered or welded to PC board.  
 b. Derate 10 mW/°C above 25 °C.

Stresses beyond those listed under "Absolute Maximum Ratings" may cause permanent damage to the device. These are stress ratings only, and functional operation of the device at these or any other conditions beyond those indicated in the operational sections of the specifications is not implied. Exposure to absolute maximum rating conditions for extended periods may affect device reliability.

RECOMMENDED OPERATING RANGE		
Parameter	Limit	Unit
$V_{DD}$	3.8 to 13.2	V
Maximum Junction Temperature ( $T_J$ )	125	°C

SPECIFICATIONS							
Parameter	Symbol	Test Conditions Unless Otherwise Specified $V_{DD} = 3.8$ to $13.2$ V $S_A$ at GND, $S_B$ at GND	Limits C Suffix, 0 to 70 °C D Suffix, - 40 to 85 °C			Unit	
			Min <sup>a</sup>	Typ <sup>b</sup>	Max <sup>a</sup>		
<b>Input</b>							
Input Voltage High	$V_{INH}$		2			V	
Input Voltage Low	$V_{INL}$				1		
Input Current with Input Voltage High	$I_{INH}$	$V_{IN} = 2$ V			1	µA	
Input Current with Input Voltage Low	$I_{INL}$	$V_{IN} = 0$ V	- 1				
<b>Output</b>							
Output Voltage High	$V_{OUTH}$	$I_{OUT} = - 500$ mA	$V_{DD} = 10.8$ V	10.5	10.7	V	
			$V_{DD} = 4.5$ V	4.1	4.3		
		$I_{OUT} = - 300$ mA, $V_{DD} = 3.8$ V		3.4	3.7		
Output Voltage Low	$V_{OUTL}$	$I_{OUT} = 500$ mA	$V_{DD} = 10.8$ V		0.2		0.3
			$V_{DD} = 4.5$ V		0.2		0.4
		$I_{OUT} = 300$ mA, $V_{DD} = 3.8$ V			0.1		0.4
Output Leakage Current High	$I_{OLH}$	$I_{NA} = I_{NB} \geq 2$ V, $V_{OUT} = V_{DD} = 13.2$ V	- 10	0		µA	
Output Leakage Current Low	$I_{OLL}$	$V_{OUT} = 0$ , $V_{DD} = 13.2$ V		0	10		
Output V Clamp High	$V_{CLH}$	$I_{NA} = I_{NB} \geq 2$ V	$I_{OUT} = 100$ mA		$V_{DD} + 0.7$	V	
Output V Clamp Low	$V_{CLL}$		$I_{OUT} = - 100$ mA		- 0.7		
<b>Supply</b>							
$V_{DD}$ Supply Current	$I_{DD}$	$I_N = 100$ kHz, $V_{DD} = 5$ V		2		mA	
		$I_{NA} = I_{NB} = 4.5$ V, $V_{DD} = 5.5$ V			300	µA	
<b>Dynamic</b>							
Propogation Delay Time	$T_{PLH}$	$V_{DD} = 5$ V		300		nS	
	$T_{PHL}$			100			

## Notes:

- a. The algebraic convention whereby the most negative value is a minimum and the most positive a maximum, is used in this data sheet.  
 b. Typical values are for DESIGN AID ONLY, not guaranteed nor subject to production testing.

**TYPICAL CHARACTERISTICS** 25 °C, unless otherwise noted

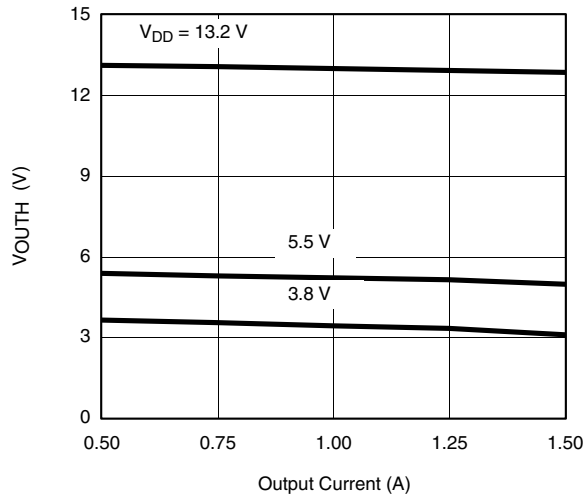

**Output High Voltage vs. Output Current**

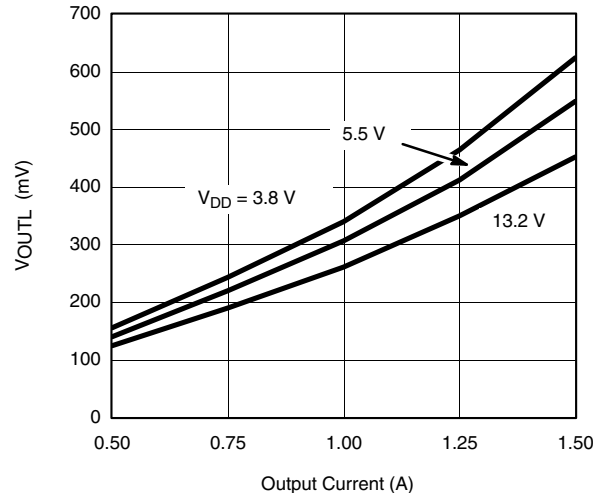

**Output Low Voltage vs. Output Current**

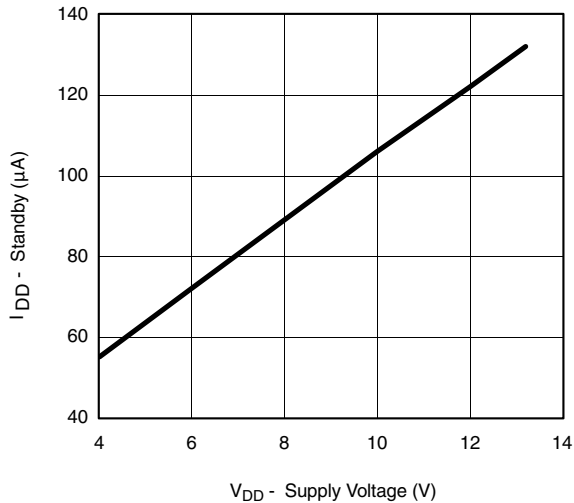

**Supply Current vs. Supply Voltage**

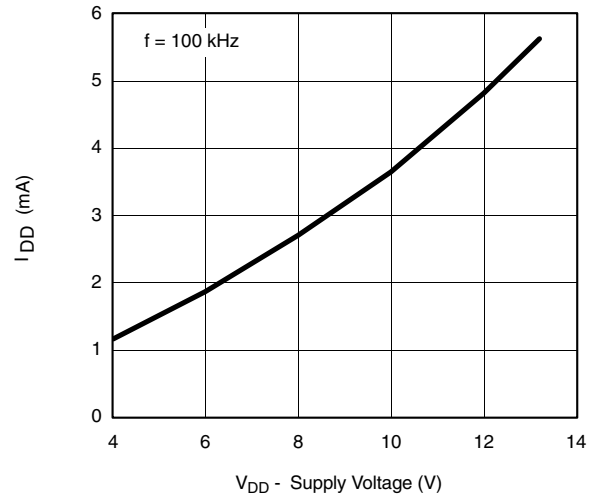

**Supply Current vs. Supply Voltage**

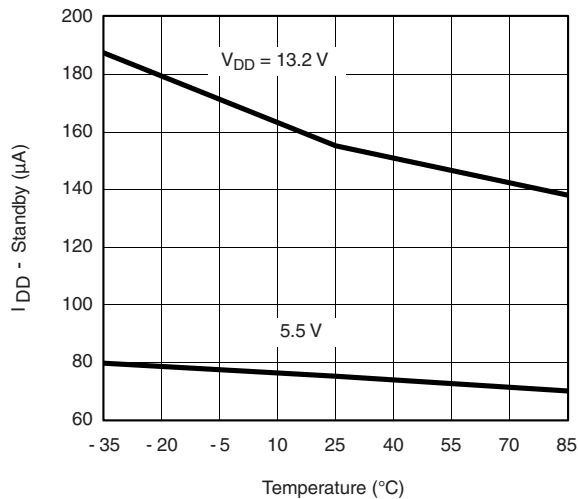

**Supply Current vs. Temperature**

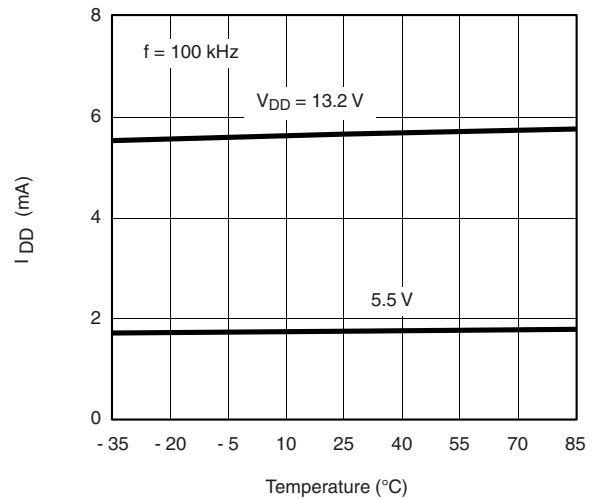

**Supply Current vs. Temperature**

**TYPICAL CHARACTERISTICS** 25 °C, unless otherwise noted

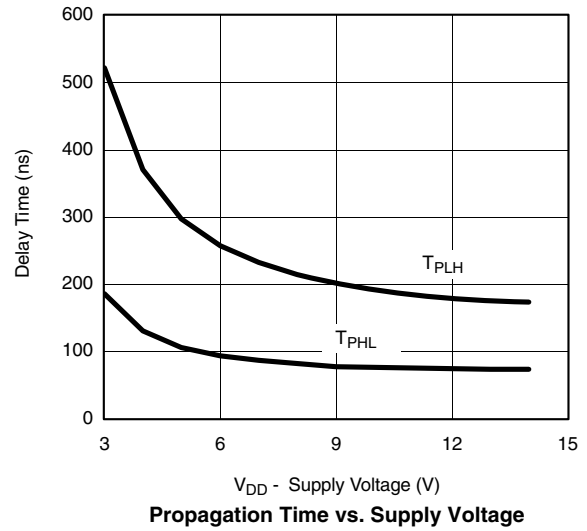
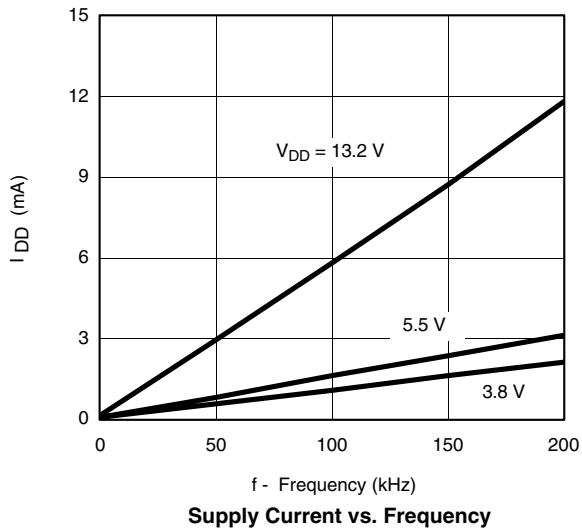

Vishay Siliconix maintains worldwide manufacturing capability. Products may be manufactured at one of several qualified locations. Reliability data for Silicon Technology and Package Reliability represent a composite of all qualified locations. For related documents such as package/tape drawings, part marking, and reliability data, see <http://www.vishay.com/ppg?70007>.



## Disclaimer

All product specifications and data are subject to change without notice.

Vishay Intertechnology, Inc., its affiliates, agents, and employees, and all persons acting on its or their behalf (collectively, "Vishay"), disclaim any and all liability for any errors, inaccuracies or incompleteness contained herein or in any other disclosure relating to any product.

Vishay disclaims any and all liability arising out of the use or application of any product described herein or of any information provided herein to the maximum extent permitted by law. The product specifications do not expand or otherwise modify Vishay's terms and conditions of purchase, including but not limited to the warranty expressed therein, which apply to these products.

No license, express or implied, by estoppel or otherwise, to any intellectual property rights is granted by this document or by any conduct of Vishay.

The products shown herein are not designed for use in medical, life-saving, or life-sustaining applications unless otherwise expressly indicated. Customers using or selling Vishay products not expressly indicated for use in such applications do so entirely at their own risk and agree to fully indemnify Vishay for any damages arising or resulting from such use or sale. Please contact authorized Vishay personnel to obtain written terms and conditions regarding products designed for such applications.

Product names and markings noted herein may be trademarks of their respective owners.