

**OBSOLETE PRODUCT
NO RECOMMENDED REPLACEMENT**
contact our Technical Support Center at
1-888-INTERSIL or www.intersil.com/tsc

High Speed, Four Channel Power MOSFET Drivers

The EL7412 contains (4) high performance matched drivers. These very high speed drivers are capable of delivering peak currents of 2.0 amps into highly capacitive loads and are ideally suited for 'Full bridge' and ultrasound applications. The high speed performance is achieved by means of a proprietary 'Turbo-Driver' circuit that speeds up input stages by tapping the wider voltage swing at the output. Improved speed and drive capability are enhanced by matched rise and fall delay times. The matched delays maintain the integrity of input-to-output pulse-widths to reduce timing errors and clock skew problems. This improved performance is accompanied by a 10 fold reduction in supply currents over bipolar drivers, yet without the delay time problems commonly associated with CMOS devices. Dynamic switching losses are minimized with non-overlapped drive techniques.

Pinout

EL7412
[20-PIN SO (0.300")]
TOP VIEW

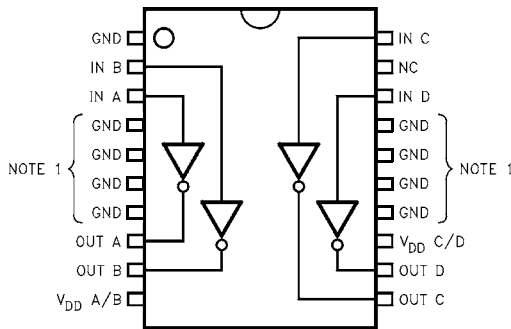

Note 1: Pins 4-7 and 14-17 are electrically connected.

Manufactured under U.S. Patent Nos. 5,334,883, #5,331,047

Features

- Excellent response times
- Matched rise and fall times
- Reduced clock skew
- Low output impedance
- Low input capacitance
- High noise immunity
- Improved clocking rate
- Low supply current
- Wide operating voltage range
- Pb-free available

Applications

- Full bridge drivers
- Clock/line drivers
- CCD Drivers
- Ultra-sound transducer drivers
- Power MOSFET drivers
- Switch mode power supplies
- Class D switching amplifiers
- Ultrasonic and RF generators
- Pulsed circuits

Ordering Information

PART NUMBER	PACKAGE	TAPE & REEL	PKG. DWG. #
EL7412CM	20-Pin SO (0.300")	-	MDP0027
EL7412CM-T13	20-Pin SO (0.300")	13"	MDP0027
EL7412CMZ (See Note)	20-Pin SO (0.300") (Pb-free)	-	MDP0027
EL7412CMZ-T13 (See Note)	20-Pin SO (0.300") (Pb-free)	13"	MDP0027

NOTE: Intersil Pb-free products employ special Pb-free material sets; molding compounds/die attach materials and 100% matte tin plate termination finish, which is compatible with both SnPb and Pb-free soldering operations. Intersil Pb-free products are MSL classified at Pb-free peak reflow temperatures that meet or exceed the Pb-free requirements of IPC/JEDEC J-Std-020C.

Absolute Maximum Ratings ($T_A = 25^\circ\text{C}$)

Supply (V+ to Gnd) 16.5V
 Input Pins -0.3V to +0.3V above V+
 Combined Peak Output Current8A
 Storage Temperature Range -65°C to +150°C

Ambient Operating Temperature -40°C to +85°C
 Operating Junction Temperature 125°C
 Power Dissipation See Curves

CAUTION: Stresses above those listed in "Absolute Maximum Ratings" may cause permanent damage to the device. This is a stress only rating and operation of the device at these or any other conditions above those indicated in the operational sections of this specification is not implied.

IMPORTANT NOTE: All parameters having Min/Max specifications are guaranteed. Typical values are for information purposes only. Unless otherwise noted, all tests are at the specified temperature and are pulsed tests, therefore: $T_J = T_C = T_A$

DC Electrical Specifications $T_A = 25^\circ\text{C}$, $V_{DD} = 15\text{V}$ unless otherwise specified

PARAMETER	DESCRIPTION	TEST CONDITIONS	MIN	TYP	MAX	UNITS
INPUT						
V_{IH}	Logic "1" Input Voltage		2.4			V
I_{IH}	Logic "1" Input Current	@ V_{DD}		0.1	10	μA
V_{IL}	Logic "0" Input Voltage				0.8	V
I_{IL}	Logic "0" Input Current	@0V		0.1	10	μA
V_{HVS}	Input Hysteresis			0.3		V
OUTPUT						
R_{OH}	Pull-Up Resistance	$I_{OUT} = -100\text{mA}$		3	6	Ω
R_{OL}	Pull-Down Resistance	$I_{OUT} = +100\text{mA}$		4	6	Ω
I_{PK}	Peak Output Current	Source Sink		2 2		A
I_{DC}	Continuous Output Current	Source/Sink	100			mA
POWER SUPPLY						
I_S	Power Supply Current	Inputs High		2	5	mA
V_S	Operating Voltage		4.5		15	V

AC Electrical Specifications $T_A = 25^\circ\text{C}$, $V = 15\text{V}$ unless otherwise specified

PARAMETER	DESCRIPTION	TEST CONDITIONS	MIN	TYP	MAX	UNITS
SWITCHING CHARACTERISTICS						
t_R	Rise Time	$C_L = 500\text{pF}$ $C_L = 1000\text{pF}$		7.5 10	20	ns
t_F	Fall Time	$C_L = 500\text{pF}$ $C_L = 1000\text{pF}$		10 13	20	ns
t_{D1}	Turn-On Delay Time	See Timing Table		18	25	ns
t_{D2}	Turn-Off Delay Time	See Timing Table		20	25	ns

Timing Table

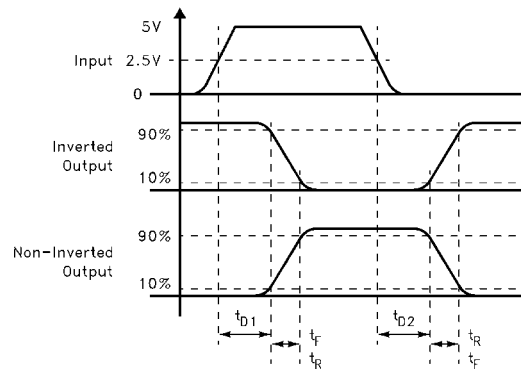

Standard Test Configuration

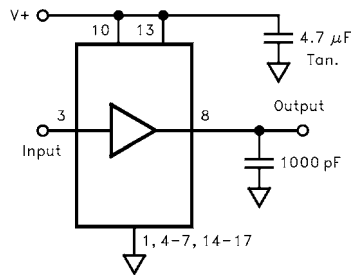

Simplified Schematic

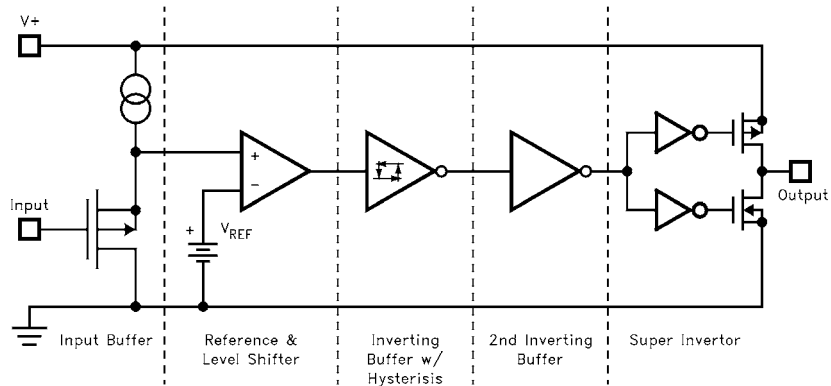

Typical Performance Curves

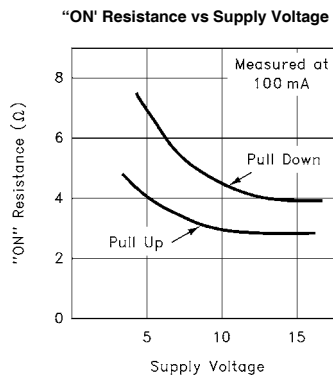
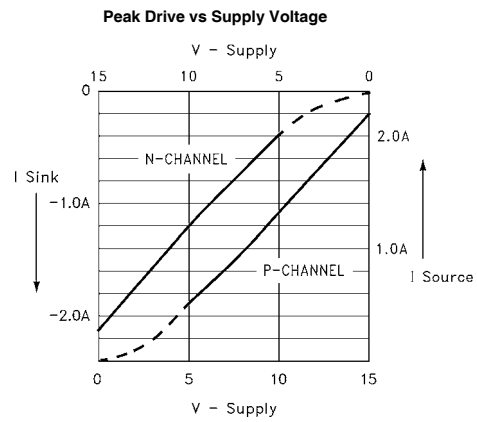
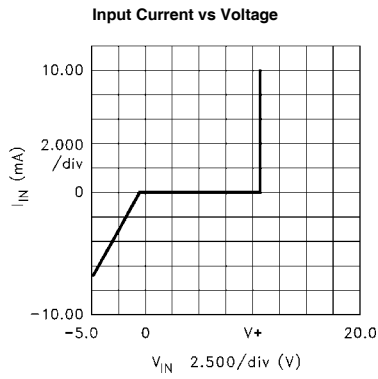
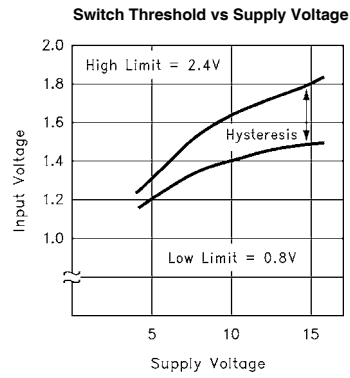
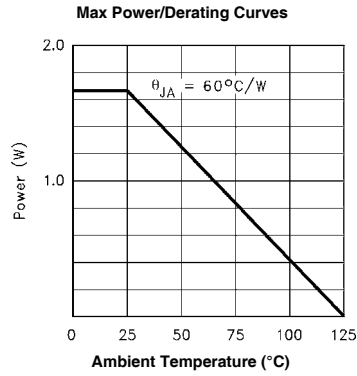

Typical Performance Curves (Continued)

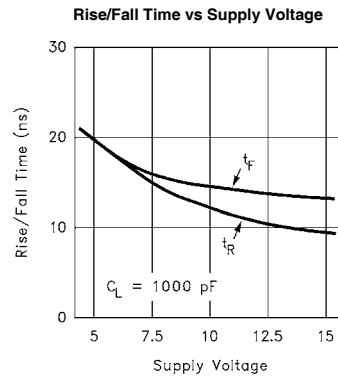
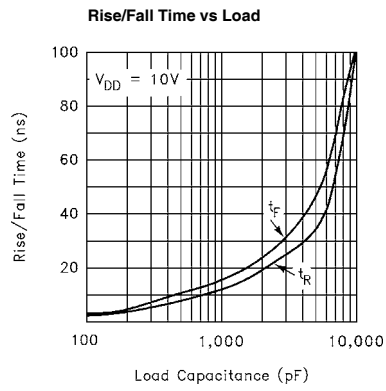
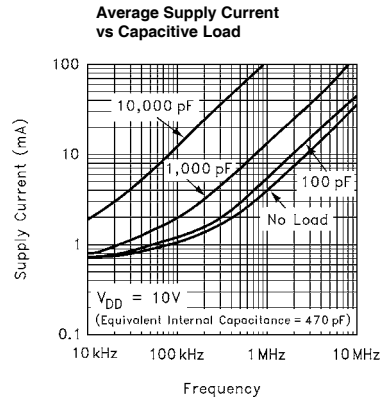
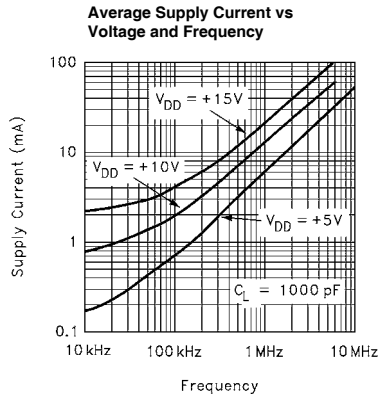

Typical Performance Curves (Continued)

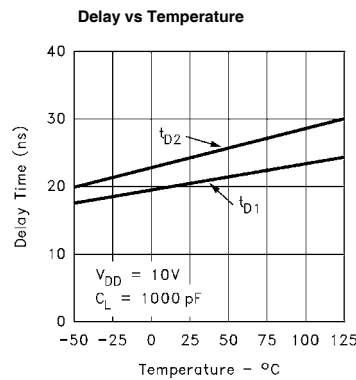
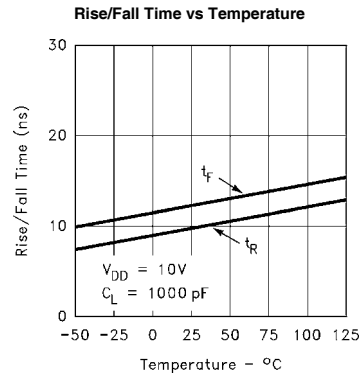
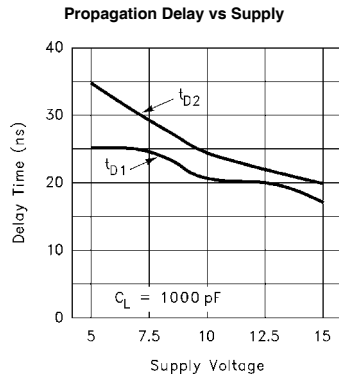

All Intersil U.S. products are manufactured, assembled and tested utilizing ISO9000 quality systems.
Intersil Corporation's quality certifications can be viewed at www.intersil.com/design/quality

Intersil products are sold by description only. Intersil Corporation reserves the right to make changes in circuit design, software and/or specifications at any time without notice. Accordingly, the reader is cautioned to verify that data sheets are current before placing orders. Information furnished by Intersil is believed to be accurate and reliable. However, no responsibility is assumed by Intersil or its subsidiaries for its use; nor for any infringements of patents or other rights of third parties which may result from its use. No license is granted by implication or otherwise under any patent or patent rights of Intersil or its subsidiaries.

For information regarding Intersil Corporation and its products, see www.intersil.com