ZXGD3002E6

9A(peak) Gate driver in SOT23-6

General description

The ZXGD3002E6 is a high-speed non-inverting single MOSFET gate driver capable of driving up to 9A into a MOSFET or IGBT gate capacitive load from supply voltages up to 20V. With typical propagation delay times down to 2ns and rise/fall times down to 11ns this device ensures rapid switching of the power MOSFET or IGBT to minimize power losses and distortion in high current fast switching applications.

The ZXGD3002E6 is inherently rugged to latch-up and shoot-through, and its wide supply voltage range allows full enhancement to minimize on-losses of the power MOSFET or IGBT.

Its low input voltage requirement and high current gain allows high current driving from low voltage controller ICs, and the optimized pin-out SOT23-6 package with separate source and sink pins eases board layout, enabling reduced parasitic inductance and independent control of rise and fall slew rates.

Features

- 20V operating voltage range
- 9 Amps peak output current
- Fast switching emitter-follower configuration
 - 2ns propagation delay time
 - 11ns rise/fall time, 1000pF load
- Low input current requirement
 - 2.2A(source)/2.0A(sink) output current from 10mA input
- SOT23-6 package
- Separate source and sink outputs for independent control of rise and fall time
- Optimized pin-out to ease board layout and minimize trace inductance
- No Latch Up
- No shoot through
- Near - Zero quiescent and output leakage current

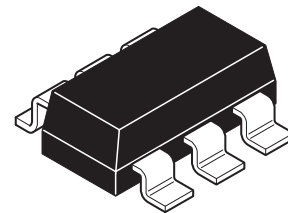

Typical application circuit

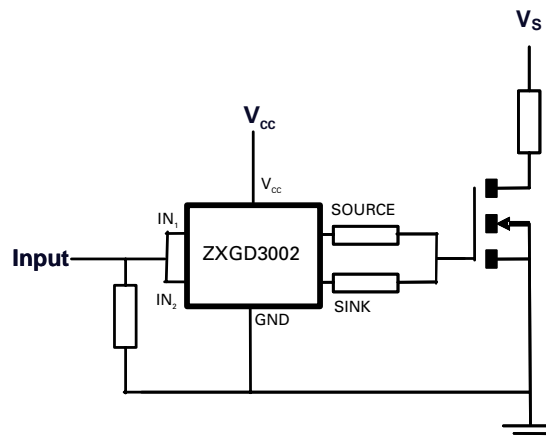

ZXGD3002E6

Applications

Power MOSFET and IGBT Gate Driving in

- Synchronous switch-mode power supplies
- Secondary side synchronous rectification
- Plasma Display Panel power modules
- 1, 2 and 3-phase motor control circuits
- Audio switching amplifier power output stages

Pin configuration

Pin Name	Pin Function
V _{CC}	Driver supply
IN ₁ / IN ₂	Driver input pins. These are normally connected together by circuit tracks
GND	Ground
SOURCE	Source current output
SINK	Sink current output

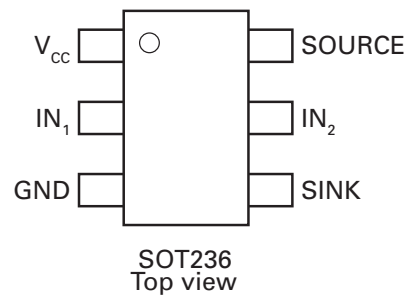

Ordering information

DEVICE	Reel size (inches)	Tape width (mm)	Quantity per reel
ZXGD3002E6TA	7	8 embossed	3000

Device marking

3002

ZXGD3002E6

Absolute maximum ratings

Parameter	Symbol	Limit	Unit
Supply voltage	V_{CC}	20	V
Input voltage	V_{IN}	20	V
Peak sink current ^(c)	$I_{(sink)PK}$	9	A
Source current @ $I_{IN1} + I_{IN2} = 10mA^{(a)}$	$I_{(source)}$	2.2	A
Sink current @ $I_{IN1} + I_{IN2} = 10mA^{(a)}$	$I_{(sink)}$	2	A
Input current ^(c)	I_{IN1}, I_{IN2}	1	A
Power dissipation at $T_A = 25^{\circ}C^{(a)(b)}$	P_D	1.1	W
Linear derating factor		8.8	mW/ $^{\circ}C$
Operating and storage temperature range	T_j, T_{stg}	-55 to +150	$^{\circ}C$

Thermal resistance

Parameter	Symbol	Value	Unit
Junction to ambient ^{(a)(b)}	$R_{\theta JA}$	113	$^{\circ}C/W$

NOTES:

- (a) For a device surface mounted on 25mm x 25mm x 0.6mm FR4 PCB with high coverage of single sided 1oz copper, in still air conditions.
- (b) For device with two active dice running at equal power.
- (c) Pulse width $\leq 300\mu s$ limit repetition rate to comply with maximum junction temperature.

ZXGD3002E6

Electrical characteristics (at $T_{amb} = 25^{\circ}\text{C}$ unless otherwise stated).

Parameter	Symbol	Min.	Typ.	Max.	Unit	Conditions
Output voltage, high	V_{OH}		$V_{CC} - 0.4$		V	$I_{SOURCE} = 1\mu\text{A}$
Output voltage, low	V_{OL}		0.4		V	$I_{SINK} = 1\mu\text{A}$
Source output leakage current	$I_{L(source)}$			1	μA	$V_{CC} = 20\text{V}$, $V_{IN1} = V_{IN2} = 0\text{V}$
Sink output leakage current	$I_{L(sink)}$			1	μA	$V_{CC} = 20\text{V}$, $V_{IN1} = V_{IN2} = V_{CC}$
Quiescent current	I_Q			50	nA	$V_{CC} = 16\text{V}$, $V_{IN1} = V_{IN2} = 0\text{V}$
Source output current	$I_{(source)}$	1.6	2.2		A	$I_{IN1} + I_{IN2} = 10\text{mA}$
Sink output current	$I_{(sink)}$	1.4	2.0		A	$I_{IN1} + I_{IN2} = 10\text{mA}$
Source output current	$I_{(source)PK}$		9		A	$I_{IN1} + I_{IN2} = 1\text{A}$
Sink output current	$I_{(sink)PK}$		9		A	$I_{IN1} + I_{IN2} = 1\text{A}$
Gate driver switching times	$t_{d(rise)}$		1.25		ns	$C_L = 1\text{nF}$, $R_L = 1\Omega$, $V_{CC} = 12\text{V}$, $V_{IN} = 10\text{V}$, $R_S = 25\Omega$
	t_r		8.3		ns	
	$t_{d(fall)}$		1.6		ns	
	t_f		10.8		ns	
Gate driver switching times	$t_{d(rise)}$		3.6		ns	$C_L = 1\text{nF}$, $R_L = 1\Omega$, $V_{CC} = 12\text{V}$, $V_{IN} = 10\text{V}$, $R_S = 1\text{k}\Omega$
	t_r		105		ns	
	$t_{d(fall)}$		6.9		ns	
	t_f		115		ns	

Switching Time Test Circuits

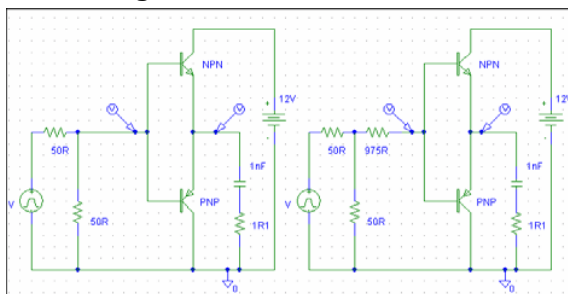

Timing Diagram

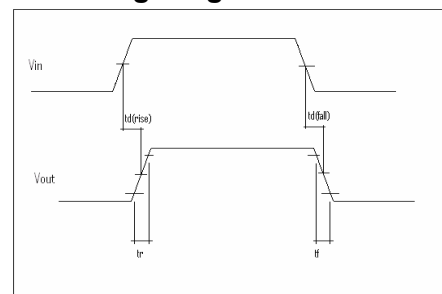

Typical gate driver characteristics

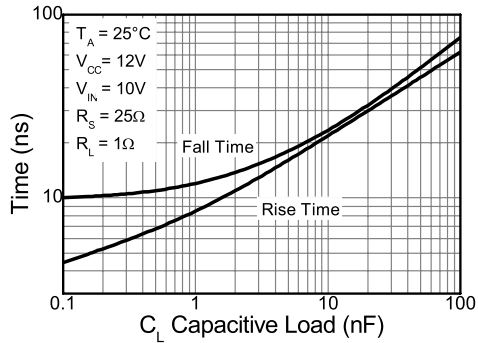

Rise and Fall Time

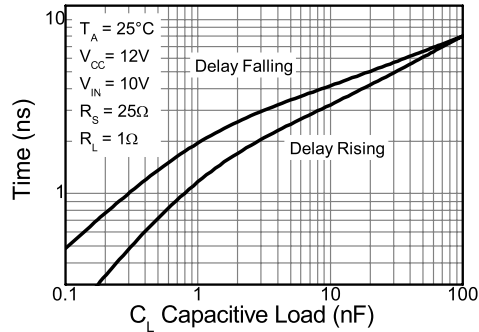

Propagation Delay

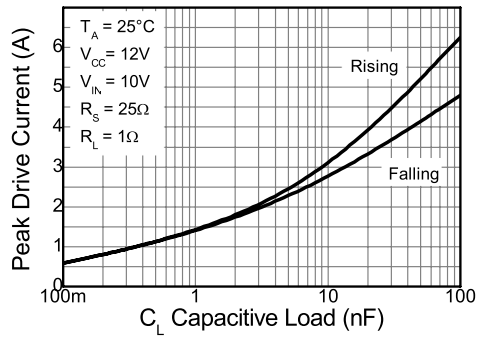

Peak Drive Current

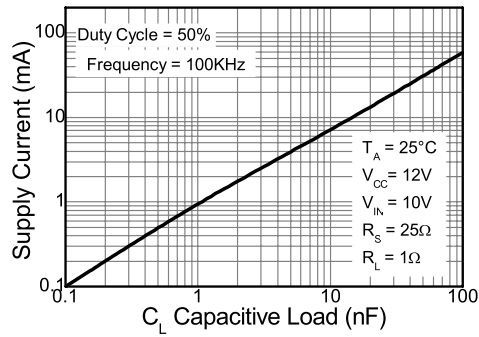

Supply Current

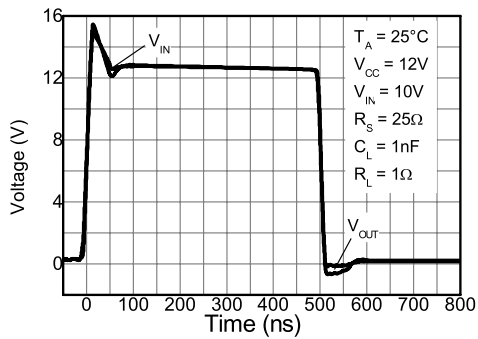

Switching Speed

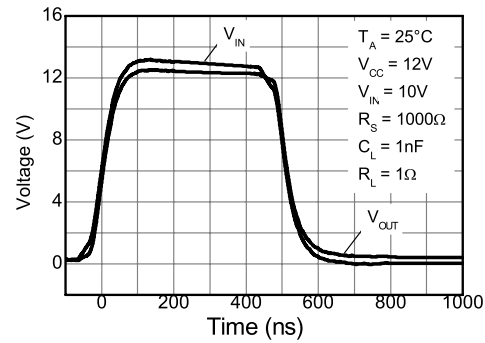

Switching Speed

ZXGD3002E6

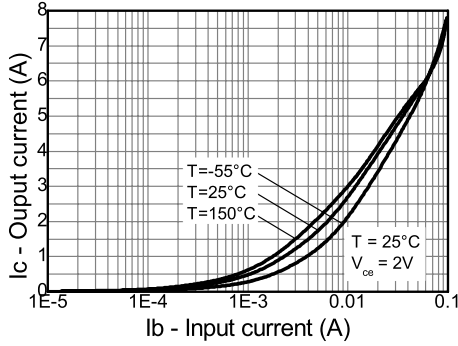

Source Current Vs Input Current

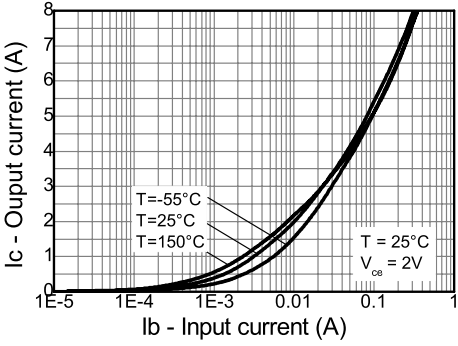

Sink Current Vs Input Current

ZXGD3002E6

SOT23-6 Package outline

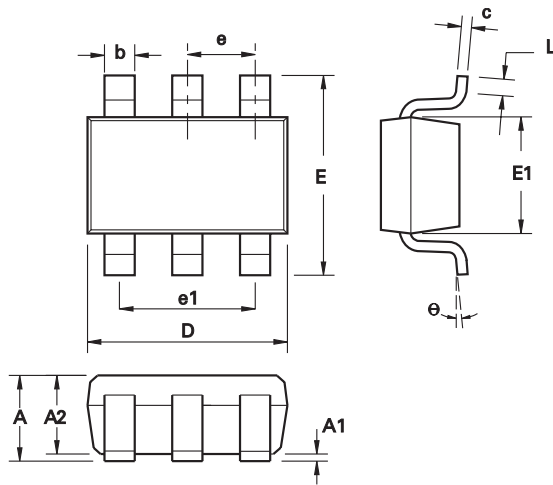

Pad layout details

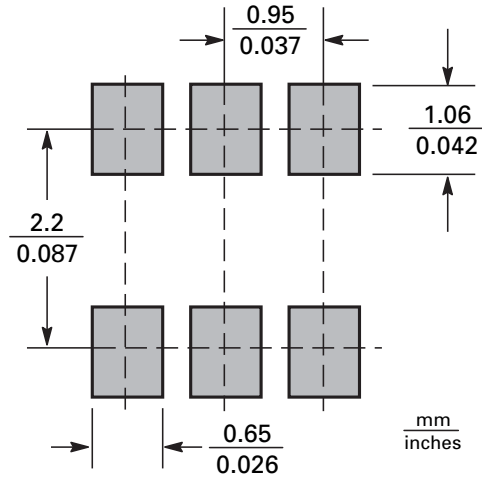

DIM	Millimeters		Inches	
	Min.	Max.	Min.	Max.
A	0.90	1.45	0.0354	0.0570
A1	0.00	0.15	0.00	0.0059
A2	0.90	1.30	0.0354	0.0511
b	0.35	0.50	0.0078	0.0196
C	0.09	0.26	0.0035	0.0102
D	2.70	3.10	0.1062	0.1220
E	2.20	3.20	0.0866	0.1181
E1	1.30	1.80	0.0511	0.0708
L	0.10	0.60	0.0039	0.0236
e	0.95 REF		0.0374 REF	
e1	1.90 REF		0.0748 REF	
L	0°	30°	0°	30°

Note: Controlling dimensions are in millimeters. Approximate dimensions are provided in inches

Definitions

Product change

Zetex Semiconductors reserves the right to alter, without notice, specifications, design, price or conditions of supply of any product or service. Customers are solely responsible for obtaining the latest relevant information before placing orders.

Applications disclaimer

The circuits in this design/application note are offered as design ideas. It is the responsibility of the user to ensure that the circuit is fit for the user's application and meets with the user's requirements. No representation or warranty is given and no liability whatsoever is assumed by Zetex with respect to the accuracy or use of such information, or infringement of patents or other intellectual property rights arising from such use or otherwise. Zetex does not assume any legal responsibility or will not be held legally liable (whether in contract, tort (including negligence), breach of statutory duty, restriction or otherwise) for any damages, loss of profit, business, contract, opportunity or consequential loss in the use of these circuit applications, under any circumstances.

Life support

Zetex products are specifically not authorized for use as critical components in life support devices or systems without the express written approval of the Chief Executive Officer of Zetex Semiconductors plc. As used herein:

A. Life support devices or systems are devices or systems which:

1. are intended to implant into the body

or

2. support or sustain life and whose failure to perform when properly used in accordance with instructions for use provided in the labeling can be reasonably expected to result in significant injury to the user.

B. A critical component is any component in a life support device or system whose failure to perform can be reasonably expected to cause the failure of the life support device or to affect its safety or effectiveness.

Reproduction

The product specifications contained in this publication are issued to provide outline information only which (unless agreed by the company in writing) may not be used, applied or reproduced for any purpose or form part of any order or contract or be regarded as a representation relating to the products or services concerned.

Terms and Conditions

All products are sold subjects to Zetex' terms and conditions of sale, and this disclaimer (save in the event of a conflict between the two when the terms of the contract shall prevail) according to region, supplied at the time of order acknowledgement.

For the latest information on technology, delivery terms and conditions and prices, please contact your nearest Zetex sales office.

Quality of product

Zetex is an ISO 9001 and TS16949 certified semiconductor manufacturer.

To ensure quality of service and products we strongly advise the purchase of parts directly from Zetex Semiconductors or one of our regionally authorized distributors. For a complete listing of authorized distributors please visit: www.zetex.com/salesnetwork

Zetex Semiconductors does not warrant or accept any liability whatsoever in respect of any parts purchased through unauthorized sales channels.

ESD (Electrostatic discharge)

Semiconductor devices are susceptible to damage by ESD. Suitable precautions should be taken when handling and transporting devices. The possible damage to devices depends on the circumstances of the handling and transporting, and the nature of the device. The extent of damage can vary from immediate functional or parametric malfunction to degradation of function or performance in use over time. Devices suspected of being affected should be replaced.

Green compliance

Zetex Semiconductors is committed to environmental excellence in all aspects of its operations which includes meeting or exceeding regulatory requirements with respect to the use of hazardous substances. Numerous successful programs have been implemented to reduce the use of hazardous substances and/or emissions.

All Zetex components are compliant with the RoHS directive, and through this it is supporting its customers in their compliance with WEEE and ELV directives.

Product status key:

"Preview"	Future device intended for production at some point. Samples may be available
"Active"	Product status recommended for new designs
"Last time buy (LTB)"	Device will be discontinued and last time buy period and delivery is in effect
"Not recommended for new designs"	Device is still in production to support existing designs and production
"Obsolete"	Production has been discontinued

Datasheet status key:

"Draft version"	This term denotes a very early datasheet version and contains highly provisional information, which may change in any manner without notice.
"Provisional version"	This term denotes a pre-release datasheet. It provides a clear indication of anticipated performance. However, changes to the test conditions and specifications may occur, at any time and without notice.
"Issue"	This term denotes an issued datasheet containing finalized specifications. However, changes to specifications may occur, at any time and without notice.

Zetex sales offices

Europe	Americas	Asia Pacific	Corporate Headquarters
Zetex GmbH Kustermann-park Balansstraße 59 D-81541 München Germany Telefon: (49) 89 45 49 49 0 Fax: (49) 89 45 49 49 49 europe.sales@zetex.com	Zetex Inc 700 Veterans Memorial Highway Hauppauge, NY 11788 USA Telephone: (1) 631 360 2222 Fax: (1) 631 360 8222 usa.sales@zetex.com	Zetex (Asia Ltd) 3701-04 Metroplaza Tower 1 Hing Fong Road, Kwai Fong Hong Kong Telephone: (852) 26100 611 Fax: (852) 24250 494 asia.sales@zetex.com	Zetex Semiconductors plc Zetex Technology Park, Chadderton Oldham, OL9 9LL United Kingdom Telephone: (44) 161 622 4444 Fax: (44) 161 622 4446 hq@zetex.com

© 2007 Published by Zetex Semiconductors plc