

LM2793

Low Noise White LED Constant Current Supply with Dual Function Brightness Control

General Description

The LM2793 is a highly efficient, semi-regulated 1.5x CMOS charge pump that provides dual constant current outputs. The LM2793 has an input voltage range of 2.7V to 5.5V.

To control LED brightness, the amount of current driven to the current-mode outputs can be adjusted with an analog voltage and/or a pulse-width-modulated (PWM) square wave.

Pre-regulation of the charge pump minimizes conducted noise on the input. Combined with a fixed switching frequency of 500kHz, the LM2793 is a low-noise solution.

The LM2793 is available in a 10-pin Leadless Lead-frame package: LLP-10.

Features

- Two Regulated Current Outputs, up to 16mA Each, Matched to Within $\pm 0.3\%$ (typ.)
- High Efficiency, 1.5x Regulated Charge Pump
- Input Voltage Range: 2.7V to 5.5V
- Soft Start Limits Inrush Current
- Analog Voltage Brightness Control
- PWM Brightness Control
- Very Small Solution Size - NO INDUCTOR
- 500kHz Switching Frequency
- 3 μ A (typ.) Shutdown Current
- LLP-10 Package: 3.0mm X 3.0mm X 0.8mm

Applications

- White LED Display Backlights
- White LED Keypad Backlights
- 1-Cell Lilon Battery-Operated Equipment Including PDAs, Hand-held PCs, Cellular Phones
- Flat Panel Displays

Typical Application Circuit

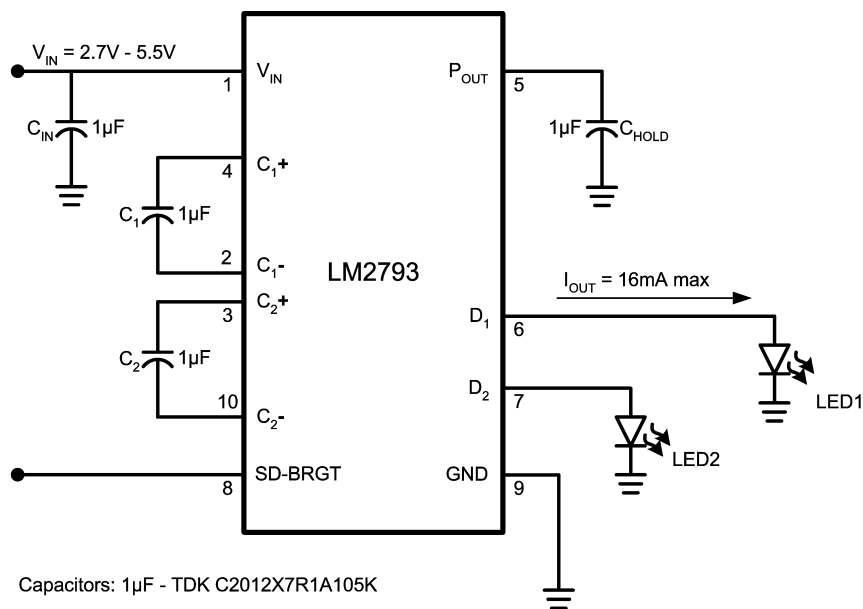

Connection Diagram

LM2793
10-pin Leadless Leadframe Package (LLP-10)
3mmx3mmx0.8mm
NS Package Number LDA10A

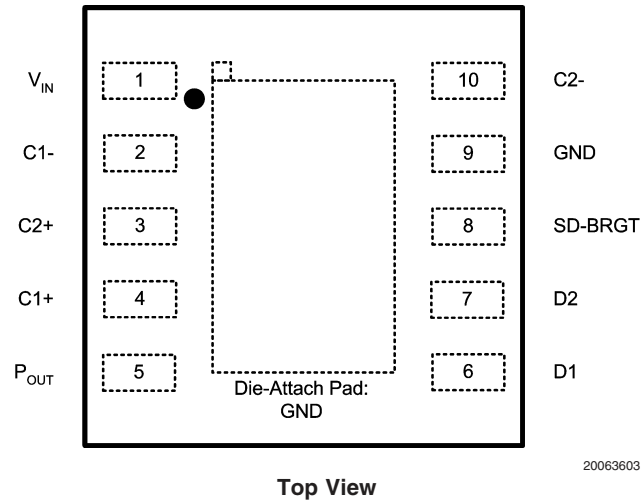

20063603

Ordering Information

Order Number	Package Description	Package Marking	Supplied as Tape and Reel (Units)
LM2793LD	LLP-10	LM2793	1000
LM2793LDX	LLP-10	LM2793	4500

Pin Description

Pin	Name	Description
1	V_{IN}	Power supply voltage connection
2	C1-	Flying capacitor C1 connection
3	C2+	Flying capacitor C2 connection
4	C1+	Flying capacitor C1 connection
5	P_{OUT}	Charge pump output
6	D1	Current source output / LED connection
7	D2	Current source output / LED connection
8	SD-BRGT	Dual function Shutdown - Brightness. Grounding pin shuts down part. Voltage between 0.75V and 2.75V (typ.) linearly adjusts current outputs. Output current equals 16mA at voltages above 2.75V.
9	GND	Power supply ground connection
10	C2-	Flying capacitor C2 connection

Absolute Maximum Ratings (Notes 1,

2)

If Military/Aerospace specified devices are required, please contact the National Semiconductor Sales Office/Distributors for availability and specifications.

V_{IN}	-0.3V to 6.0V
$V_{SD-BRGT}$	-0.3V to ($V_{IN} + 0.3V$) w/ 6.0V max

Continuous Power Dissipation (Note

4) Internally Limited

Junction Temperature ($T_{J-MAX-ABS}$) 150°C

Storage Temperature Range -65°C to 150°C

Lead Temp. (Soldering, 5 sec.) 260°C

ESD Rating (Note 5) 200V

Human Body Model 2kV

Machine Model 200V

Operating Ratings (Notes 2, 8)Input Voltage V_{IN} 2.7V to 5.5V $V_{SD-BRGT}$ 0V to V_{IN}

Brightness Adjustment Control

Range of $V_{SD-BRGT}$ 0.75V to 2.75VJunction Temperature Range (T_J) -30°C to +100°CAmbient Temperature Range (T_A) -30°C to +85 °C
(Note 6)**Thermal Information**

Junction-to-Ambient Thermal

Resistance,

LLP-10 Package (θ_{JA}) (Note 7) 55°C/W**Electrical Characteristics** (Notes 2, 8)

Limits in standard typeface are for $T_J = 25^\circ\text{C}$, and limits in **boldface** type apply over the full operating junction temperature range. Unless otherwise specified: $C_1=C_2=C_{IN}=C_{HOLD}=1\mu\text{F}$; $V_{IN}=3.6\text{V}$; $V_{SD-BRGT}=3.0\text{V}$; $V_{DX}=3.6\text{V}$

Symbol	Parameter	Conditions	Min	Typ	Max	Units
I_{DX}	Output Current Regulation	$3.3\text{V} \leq V_{IN} \leq 5.5\text{V}$ $V_{DX} = 3.9\text{V}$	14.7	15.9	17.2	mA
		$3.0\text{V} \leq V_{IN} \leq 5.5\text{V}$ $V_{DX} = 3.8\text{V}$	14.7	15.9	17.3	
		$2.7\text{V} \leq V_{IN} \leq 5.5\text{V}$ $V_{DX} = 3.4\text{V}$	14.7	15.9	17.3	
		$2.5\text{V} \leq V_{DX} \leq 3.9\text{V}$ (Note 9)	14.7	15.9	17.3	
		$V_{SD-BRGT} = 2.0\text{V}$		10		
		$V_{SD-BRGT} = 0.75\text{V}$		0.1		
$I_{D-MATCH}$	I_{D1} -to- I_{D2} Current Matching			0.3	3.0	%
R_{OUT}	Charge Pump Output Resistance	$V_{IN} = 2.7\text{V}$		3.5		Ω
V_{HR-min}	Minimum Current Source Voltage Headroom ($V_{P-OUT} - V_{IDX}$) (Note 10)	$I_{DX} = 16\text{mA}$		400		mV
I_Q	Quiescent Supply Current	$I_{DX}, I_{P-OUT} = 0$		1.2	2.2	mA
I_{SD}	Shutdown Supply Current	$2.7\text{V} \leq V_{IN} \leq 5.5\text{V}$ $V_{SD-BRGT} = 0\text{V}$		3	5	μA
ON/OFF	SD-BRGT Pin Thresholds for Active and Shutdown Modes	Active $V_{IN} = 3.0\text{V}$	0.70			V
		Shutdown $V_{IN} = 3.0\text{V}$			0.25	
$I_{LEAK-SD}$	SD-BRGT Pin Leakage Current			17		μA
f_{SW}	Switching Frequency	$2.7\text{V} \leq V_{IN} \leq 5.5\text{V}$	325	500	675	kHz
t_{START}	Startup Time	$I_{DX} = 90\%$ steady state		30		μs

Note 1: Absolute Maximum Ratings indicate limits beyond which damage to the component may occur. Operating Ratings are conditions under which operation of the device is guaranteed. Operating Ratings do not imply guaranteed performance limits. For guaranteed performance limits and associated test conditions, see the Electrical Characteristics tables.

Note 2: All voltages are with respect to the potential at the GND pin.

Note 3: Voltage on the SD-BRGT pin should not exceed 6V.

Note 4: Thermal shutdown circuitry protects the device from permanent damage. D_1 and D_2 may be shorted to GND without damage.

Electrical Characteristics (Notes 2, 8) (Continued)

Note 5: The human-body model is a 100 pF capacitor discharged through a 1.5 k resistor into each pin. The machine model is a 200pF capacitor discharged directly into each pin.

Note 6: Maximum ambient temperature (T_{A-MAX}) is dependent on the maximum operating junction temperature ($T_{J-MAX-OP} = 100^{\circ}C$), the maximum power dissipation of the device in the application (P_{D-MAX}), and the junction-to-ambient thermal resistance of the part/package in the application (θ_{JA}), as given by the following equation: $T_{A-MAX} = T_{J-MAX-OP} - (\theta_{JA} \times P_{D-MAX})$. The ambient temperature operating rating is provided merely for convenience. This part may be operated outside the listed T_A rating, so long as the junction temperature of the device does not exceed the maximum operating rating of $100^{\circ}C$.

Note 7: Junction-to-ambient thermal resistance is highly application and board-layout dependent. In applications where high maximum power dissipation exists, special care must be paid to thermal dissipation issues. For more information on these topics, please refer to the **Power Dissipation** section of this datasheet.

Note 8: All room temperature limits are 100% tested or guaranteed through statistical analysis. All limits at temperature extremes are guaranteed by correlation using standard Statistical Quality Control methods (SQC). All limits are used to calculate Average Outgoing Quality Level (AOQL). Typical numbers are not guaranteed, but do represent the most likely norm.

Note 9: Maximum LED voltage (V_{Dx}) is highly dependent on the application's minimum input voltage and the amount of current flowing through the LEDs. Maximum LED voltage for a given application can be approximated with the following equations:

$$V_{IN-MIN} < 3.0V: V_{Dx-MAX} = (1.5 \times V_{IN-MIN}) - (I_{Dx} \times 25 \text{ mV/mA}) - (3.5\Omega \times 2 \times I_{Dx})$$

$$V_{IN-MIN} \geq 3.0V: V_{Dx-MAX} = 4.3V - (I_{Dx} \times 25 \text{ mV/mA})$$

The equations above assume LEDs are connected to outputs D_1 and D_2 , and no current drawn from the charge pump output (P_{OUT}). For a more precise and thorough analysis of maximum LED voltage, please refer to text sections of the datasheet (to appear in future datasheet revisions - in the interim, please contact National Semiconductor for more information).

Note 10: Current sources are connected internally between P_{OUT} and I_{Dx} . The voltage across each current source, $[V(P_{OUT}) - V(I_{Dx})]$, is referred to as headroom voltage. For current sources to regulate properly, a minimum headroom voltage must be present across them. Minimum required headroom voltage is proportional to the current flowing through the current source, as dictated by this equation: $V_{HR-min} = 400mV \times (I_{Dx} / 16mA)$.

Block Diagram

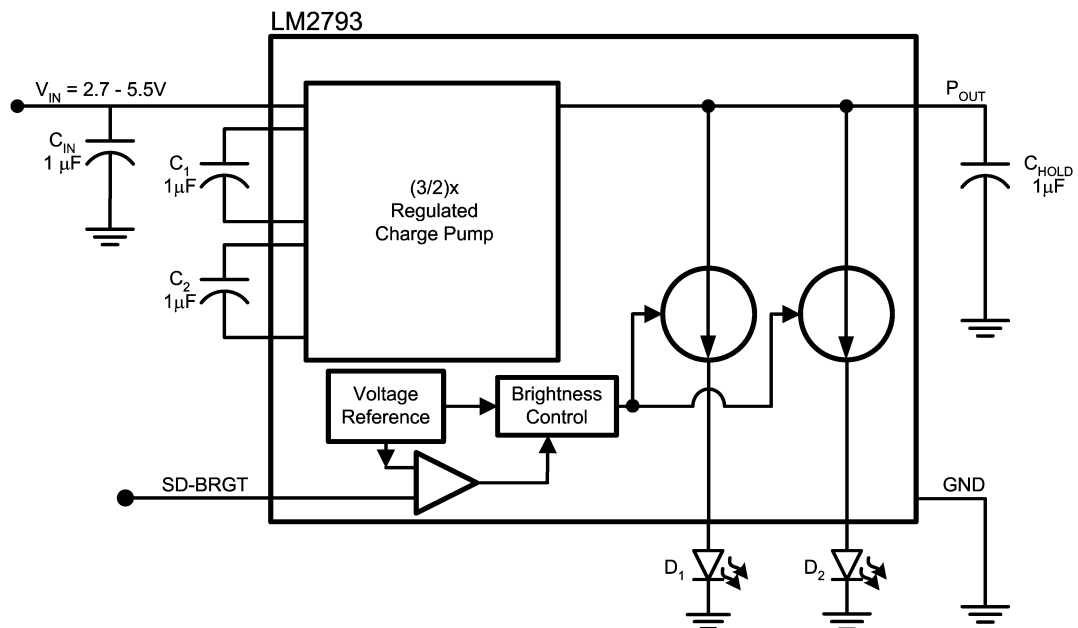

20063601

Typical Performance Characteristics Unless otherwise specified: $T_A = 25^\circ\text{C}$, 2 LEDs, $V_{DX} = 3.6\text{V}$, $V_{IN} = 3.6$, $V_{SD-BRGT} = 3.0$, $C_1 = C_2 = C_{IN} = C_{HOLD} = 1\mu\text{F}$. Capacitors are low-ESR multi-layer ceramic capacitors (MLCC's).

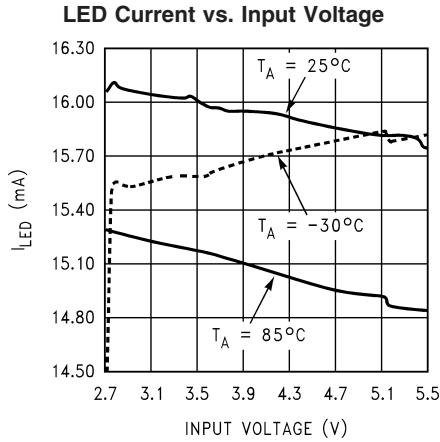

20063606

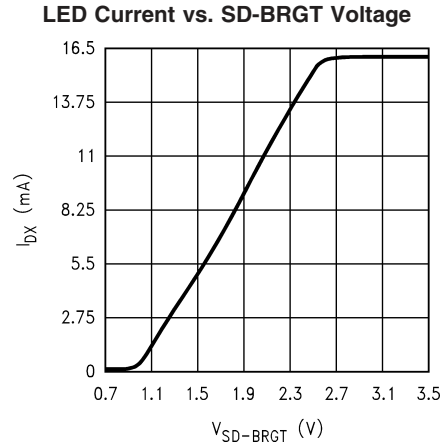

20063607

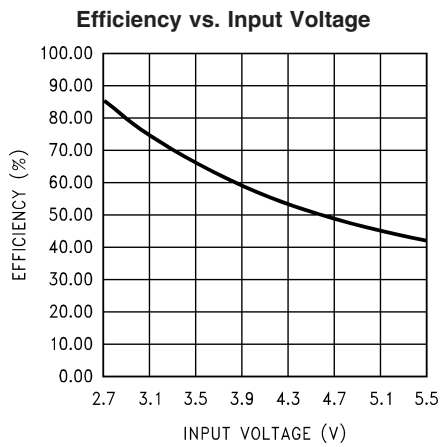

20063612

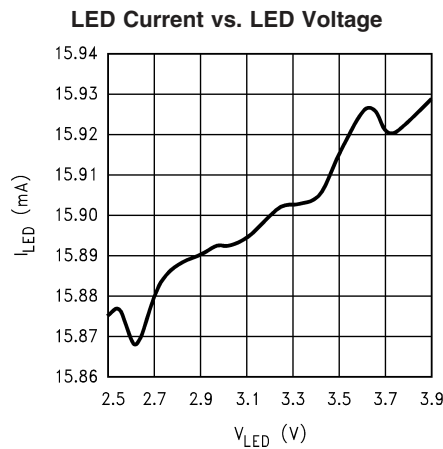

20063608

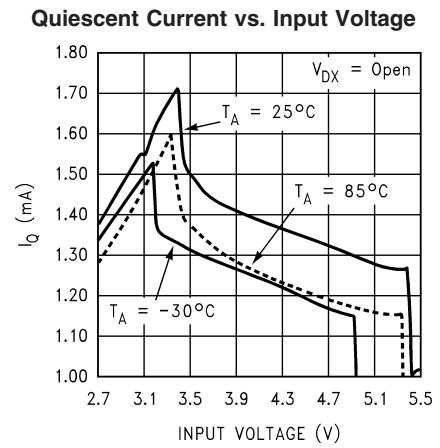

20063609

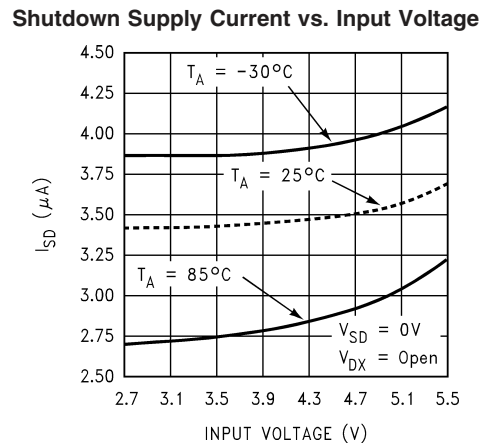

20063610

Typical Performance Characteristics Unless otherwise specified: $T_A = 25^\circ\text{C}$, 2 LEDs, $V_{\text{DX}} = 3.6\text{V}$, $V_{\text{IN}} = 3.6$, $V_{\text{SD-BRGT}} = 3.0$, $C_1 = C_2 = C_{\text{IN}} = C_{\text{HOLD}} = 1\mu\text{F}$. Capacitors are low-ESR multi-layer ceramic capacitors (MLCC's). (Continued)

Output Resistance vs. Temperature

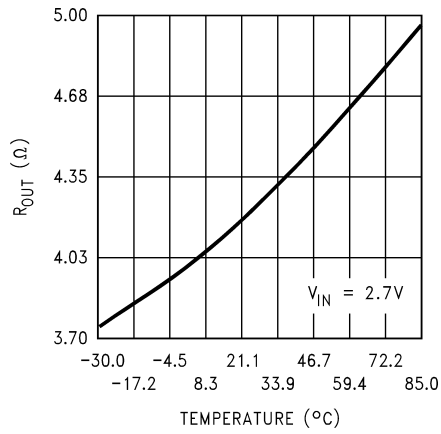

20063611

Startup Response

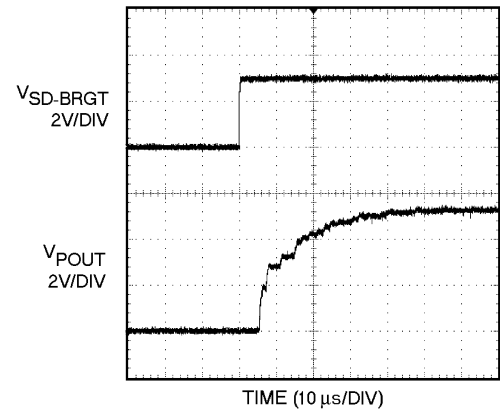

20063614

Application Information

CIRCUIT DESCRIPTION

The LM2793 is a 1.5x CMOS charge pump that provides two matched constant current outputs for driving up to 16mA through high forward voltage drop White LEDs from Li-Ion battery sources. The device has two regulated current sources connected to the output of the device's 1.5x loosely regulated charge pump (P_{OUT}). The device's loosely-regulated charge pump has both open loop and closed loop modes of operation. When the device is in open loop, the voltage at P_{OUT} is 1.5 times the voltage at the input. When the device is in closed loop, the voltage at P_{OUT} is loosely regulated to 4.9V (typ.). To set the LED drive current, the device uses the voltage applied to the dual function shutdown-brightness pin (SD-BRGT) to set a reference current. This reference current is then multiplied and mirrored to each current output. The LED brightness can be controlled by both analog and/or digital methods. The digital technique uses a PWM (Pulse Width Modulation) signal applied to the SD-BRGT pin. The analog technique applies an analog voltage in the range of 0.7V to 2.75V to the SD-BRGT pin to vary the LED current (see Shutdown and Brightness Control).

SOFT START

LM2793 includes a soft start function to reduce the inrush currents and high peak current during power up of the device. Soft start is implemented internally by ramping the reference voltage more slowly than the applied voltage. During soft start, the switch resistances limit the inrush current used to charge the flying and hold capacitors.

SHUTDOWN AND BRIGHTNESS CONTROL

The LM2793 has an active-low dual function shutdown-brightness control pin, SD-BRGT. A voltage higher than 0.65V (typ.) on SD-BRGT will put the LM2793 in active mode. Applying a voltage below 0.35V (typ.) on the SD-BRGT pin will turn off the device, reducing the quiescent current to 3 μ A (typ.).

The LM2793 has the ability to adjust LED brightness by applying an analog voltage or a PWM signal to the SD-BRGT pin. For constant brightness or analog brightness control, continue with "Analog brightness control" below. Otherwise go to "Brightness control using PWM".

1. Analog brightness control

The current for the dual LED outputs can be adjusted by varying the voltage on the SD-BRGT pin. The typical range for adjusting LED brightness is between 0.7 and 2.75V. Figure 1 shows how the current changes with respect to the voltage applied to SD-BRGT. If full brightness (16mA) is desired, the voltage on SD-BRGT should be greater than 2.75V (typ.) but not more than V_{IN} .

2. Brightness control using PWM

Increasing and decreasing the duty cycle of the PWM signal controls the LED brightness. Zero duty cycle will turn off the LEDs and a 50% duty cycle will result in an average I_{LED} being half of the maximum LED current. The recommended frequency range for the PWM signal is between 100Hz and 1kHz. If the PWM frequency is much less than 100Hz, flicker may be seen in the LEDs. If the frequency is much higher than 1kHz, brightness in the LEDs will not adjust linearly with duty cycle due to the 30 μ s (typ.) start-up time of the device. The voltage level for the PWM signal should be greater than 2.75V (typ.) but not exceed the voltage on V_{IN} .

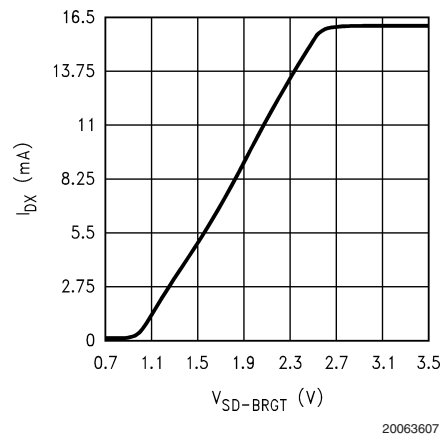

FIGURE 1. LED Current vs. $V_{SD-BRGT}$
2 LEDs, $V_{DX} = 3.6V$, $V_{IN} = 3.6V$

CAPACITOR SELECTION

The LM2793 requires 4 external capacitors for proper operation. Surface-mount multi-layer ceramic capacitors are recommended. These capacitors are small, inexpensive and have very low equivalent series resistance (ESR, $\leq 15m\Omega$ typ.). Tantalum capacitors, OS-CON capacitors, and aluminum electrolytic capacitors are generally not recommended for use with the LM2793 due to their high ESR, as compared to ceramic capacitors.

For most applications, ceramic capacitors with X7R or X5R temperature characteristic are preferred for use with the LM2793. These capacitors have tight capacitance tolerance (as good as $\pm 10\%$), hold their value over temperature (X7R: $\pm 15\%$ over $-55^\circ C$ to $125^\circ C$; X5R: $\pm 15\%$ over $-55^\circ C$ to $85^\circ C$), and typically have little voltage coefficient. Capacitors with Y5V or Z5U temperature characteristic are generally not recommended for use with the LM2793. Capacitors with these temperature characteristics typically have wide capacitance tolerance ($+80\%$, -20%), vary significantly over temperature (Y5V: $+22\%$, -82% over $-30^\circ C$ to $+85^\circ C$ range; Z5U: $+22\%$, -56% over $+10^\circ C$ to $+85^\circ C$ range), and have poor voltage coefficients. Under some conditions, a nominal 1 μ F Y5V or Z5U capacitor could have a capacitance of only 0.1 μ F. Such detrimental deviation is likely to cause Y5V and Z5U capacitors to fail to meet the minimum capacitance requirements of the LM2793. Table 1 lists suggested capacitor suppliers for the typical application circuit.

TABLE 1. Ceramic Capacitor Manufacturers

Manufacturer	Contact
TDK	www.component.tdk.com
Murata	www.murata.com
Taiyo Yuden	www.t-yuden.com

LED SELECTION

The LM2793 is designed to drive LEDs with a forward voltage of about 3.0V to 4.0V. The typical and maximum diode forward voltage depends highly on the manufacturer and their technology. Table 2 lists two suggested manufacturers. Forward current matching is assured over the LED process variations due to the constant current output of the LM2793.

Application Information (Continued)

TABLE 2. White LED Selection

Manufacturer	Contact
Osram	www.osram-os.com
Nichia	www.nichia.com

PARALLEL DX OUTPUTS FOR INCREASED CURRENT DRIVE

Outputs D_1 and D_2 may be connected together to drive a single LED. In such a configuration, two parallel current sources of equal value drive the single LED. The voltage on SD-BRGT should be chosen so that the current through each of the outputs is programmed to 50% of the total desired LED current. For example, if 30mA is the desired drive current for the single LED, SD-BRGT should be selected so that the current through each of the outputs is 15mA. Connecting the outputs in parallel does not affect internal operation of the LM2793 and has no impact on the Electrical Characteristics and limits previously presented. The available diode output current, maximum diode voltage, and all other specifications provided in the Electrical Characteristics table apply to this parallel output configuration, just as they do to the standard 2-LED application circuit.

P_{OUT}

P_{OUT} uses pre-regulation to loosely regulate the output of the LM2793 1.5x charge pump. Pre-regulation uses the voltage present at P_{OUT} to limit the gate drive of the 1.5x switched capacitor charge pump. Pre-regulation helps to reduce input current noise and large input current spikes normally associated with switched capacitor charge pumps. At voltages below 3.3V (typ.), the LM2793 acts as an open loop charge pump. When the device is in open loop, the voltage at P_{OUT} is 1.5 times the input voltage. At input voltages higher than 3.3V (typ.) P_{OUT} is loosely regulated to 4.9V (typ.).

POWER EFFICIENCY

Figure 2 shows the efficiency of the LM2793.

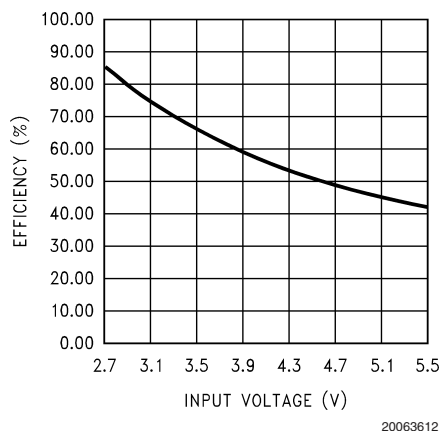

FIGURE 2. Efficiency vs. V_{IN}
2 LEDs, $V_{LED} = 3.6V$, $I_{LED} = 16mA$

Efficiency (E) of the LM2793 is defined here as the ratio of the power consumed by LEDs (P_{LED}) to the power drawn from the input source (P_{IN}). In the equations below, I_Q is the quiescent current of the LM2793, I_{LED} is the current flowing

through one LED, and V_{LED} is the forward voltage at that LED current. In the input power calculation, the 1.5 multiplier reflects the 3/2 switched capacitor gain of the LM2793.

$$P_{LED} = N \times V_{LED} \times I_{LED}$$

$$P_{IN} = V_{IN} \times I_{IN}$$

$$P_{IN} = V_{IN} \times (1.5 \times N \times I_{LED} + I_Q)$$

$$E = (P_{LED} \div P_{IN})$$

It is also worth noting that efficiency as defined here is in part dependent on LED voltage. Variation in LED voltage does not affect power consumed by the circuit and typically does not relate to the brightness of the LED. For an advanced analysis, it is recommended that power consumed by the circuit ($V_{IN} \times I_{IN}$) be evaluated rather than power efficiency. Power consumption of the LM2793 Typical Application Circuit is shown in Figure 3.

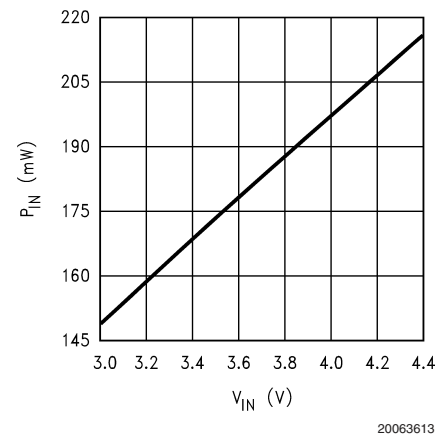

FIGURE 3. I_{LED} current vs. P_{IN}
2 LEDs, $2.5 \leq V_{LED} \leq 3.9V$, $I_{LED} = 16mA$

THERMAL PROTECTION

When the junction temperature exceeds 150°C, the LM2793 internal thermal protection circuitry disables the part. This feature protects the device from damage due to excessive power dissipation. The device will recover and operate normally when the junction temperature falls below 125°C. It is important to have good thermal conduction with a proper layout to reduce thermal resistance.

POWER DISSIPATION

When operating within specified operating ratings, the peak power dissipation ($P_{DISSIPATION}$) of the LM2793 occurs at an input voltage of 5.5V. Assuming a typical junction-to-ambient thermal resistance (θ_{JA}) for the LLP-10 package of 55°C/W, a LED forward voltage (V_{DX}) of 3.6V, and a total load (I_{LOAD}) of 32mA for two White LEDs connected to D_1 and D_2 , the power dissipation and junction temperature (T_J) are calculated below for a part operating at the maximum rated ambient temperature (T_A) of 85°C. In the equations below, V_{IN} is the input voltage to the LM2793, P_{IN} is the power generated by the 1.5x charge pump, and P_{LED} is the power consumed by the LEDs.

$$P_{DISSIPATION} = P_{IN} - P_{LED}$$

$$= (1.5V_{IN} - V_{DX}) \times I_{LOAD}$$

$$= ((1.5 \times 5.5V) - 3.6V) \times 0.032A$$

$$= 149mW$$

Application Information (Continued)

$$\begin{aligned} T_J &= T_A + (P_{DMAX} \times \theta_{JA}) \\ &= 85^\circ\text{C} + (0.149\text{W} \times 55^\circ\text{C/W}) \\ &= 93^\circ\text{C} \end{aligned}$$

The junction temperature rating takes precedence over the ambient temperature rating. The LM2793 may be operated outside the ambient temperature rating, so long as the junction temperature of the device does not exceed the maximum operating rating of 100°C. The maximum ambient temperature rating must be derated in applications where high power dissipation and/or poor thermal resistance causes the junction temperature to exceed 100°C.

PCB Layout Considerations

The LLP is a leadframe based Chip Scale Package (CSP) with very good thermal properties. This package has an exposed DAP (die attach pad) at the center of the package

measuring 2.0mm x 1.2mm. The main advantage of this exposed DAP is to offer lower thermal resistance when it is soldered to the thermal land on the PCB. For PCB layout, National highly recommends a 1:1 ratio between the package and the PCB thermal land. To further enhance thermal conductivity, the PCB thermal land may include vias to a ground plane. For more detailed instructions on mounting LLP packages, please refer to National Semiconductor Application Note AN-1187.

Physical Dimensions inches (millimeters) unless otherwise noted

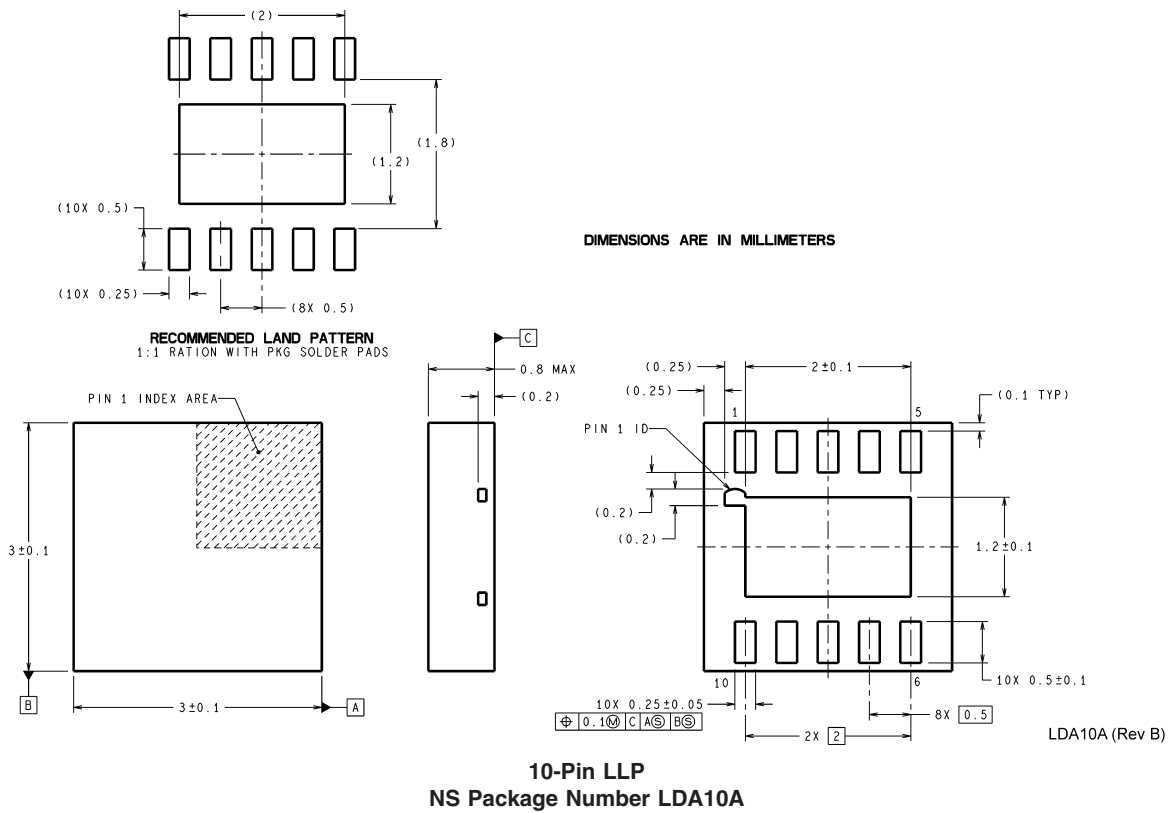

LIFE SUPPORT POLICY

NATIONAL'S PRODUCTS ARE NOT AUTHORIZED FOR USE AS CRITICAL COMPONENTS IN LIFE SUPPORT DEVICES OR SYSTEMS WITHOUT THE EXPRESS WRITTEN APPROVAL OF THE PRESIDENT AND GENERAL COUNSEL OF NATIONAL SEMICONDUCTOR CORPORATION. As used herein:

1. Life support devices or systems are devices or systems which, (a) are intended for surgical implant into the body, or (b) support or sustain life, and whose failure to perform when properly used in accordance with instructions for use provided in the labeling, can be reasonably expected to result in a significant injury to the user.
2. A critical component is any component of a life support device or system whose failure to perform can be reasonably expected to cause the failure of the life support device or system, or to affect its safety or effectiveness.



National Semiconductor
Americas Customer
Support Center
Email: new.feedback@nsc.com
Tel: 1-800-272-9959

www.national.com

National Semiconductor
Europe Customer Support Center
Fax: +49 (0) 180-530 85 86
Email: europe.support@nsc.com
Deutsch Tel: +49 (0) 69 9508 6208
English Tel: +44 (0) 870 24 0 2171
Français Tel: +33 (0) 1 41 91 8790

National Semiconductor
Asia Pacific Customer
Support Center
Fax: +65-6250 4466
Email: ap.support@nsc.com
Tel: +65-6254 4466

National Semiconductor
Japan Customer Support Center
Fax: 81-3-5639-7507
Email: jpn.feedback@nsc.com
Tel: 81-3-5639-7560