

Integrated 16-Channel LED Driver with Switch-Mode Boost and SEPIC Controller

ABSOLUTE MAXIMUM RATINGS

V _{CC} to AGND	-0.3V to +30V	OUT0–OUT15 Sink Current	60mA
Current into V _{CC} (V _{CC} > 24V)	30mA	Total PGND Current (1s pulse time)	960mA
V ₊ to PGND	-0.3V to +6V	Continuous Power Dissipation (T _A = +70°C)	
OUT to AGND	-0.3V to (V _{CC} + 0.3V)	38-Pin TQFN (derate 35.7mW/°C* above +70°C)	2857mW
OUT Current (10μs duration)	±1A	Operating Temperature Range	-40°C to +125°C
FB, COMP, CS, RTCT, REF to AGND	-0.3V to +6V	Junction Temperature	+150°C
COMP Sink Current	10mA	Storage Temperature Range	-65°C to +150°C
OUT0–OUT15 to PGND	-0.3V to +40V	Lead Temperature (soldering, 10s)	+300°C
DIN, CLK, LE, OE, SET to PGND	-0.3V to (V ₊ + 0.3V)		
DOUT Current	±10mA		

*Per JEDEC51 Standard (Multilayer Board).

Stresses beyond those listed under "Absolute Maximum Ratings" may cause permanent damage to the device. These are stress ratings only, and functional operation of the device at these or any other conditions beyond those indicated in the operational sections of the specifications is not implied. Exposure to absolute maximum rating conditions for extended periods may affect device reliability.

ELECTRICAL CHARACTERISTICS (PWM CONTROLLER)

(V_{CC} = +15V, V₊ = +3V to +5.5V referenced to PGND, R_T = 10kΩ, C_T = 3.3nF, REF = open, COMP = open, C_{REF} = 0.1μF, V_{FB} = 2V, CS = AGND, AGND = PGND = 0V; all voltages are measured with respect to AGND, unless otherwise noted. T_J = T_A = -40°C to +125°C, unless otherwise noted. Typical values are at T_A = +25°C.) (Note 1)

PARAMETER	SYMBOL	CONDITIONS	MIN	TYP	MAX	UNITS
REFERENCE						
Output Voltage	V _{REF}	I _{REF} = 1mA, T _J = +25°C	4.95	5	5.05	V
Line Regulation	ΔV _{LINE}	12V < V _{CC} < 25V, I _{REF} = 1mA		0.4	4	mV
Load Regulation	ΔV _{LOAD}	1mA < I _{REF} < 20mA		6	50	mV
Total Output-Voltage Variation	V _{REFT}	(Note 2)	4.875		5.125	V
Output Noise Voltage	V _{NOISE}	10Hz < f < 10kHz		50		μV
Output Short-Circuit Current	I _{SHORT}	V _{REF} = 0V	30		180	mA
OSCILLATOR						
Initial Accuracy		T _J = +25°C	51	54	57	kHz
Voltage Stability		12V < V _{CC} < 25V		0.2	0.5	%
Temperature Stability				1		%
RTCT Ramp Peak-to-Peak				1.7		V
RTCT Ramp Valley				1.1		V
Discharge Current	I _{DIS}	V _{RTCT} = 2V, T _J = +25°C	7.9	8.3	8.7	mA
		V _{RTCT} = 2V, -40°C ≤ T _J ≤ +125°C	7.5	8.3	9.0	
Frequency Range	f _{OSC}		20		1000	kHz
ERROR AMPLIFIER						
FB Input Voltage	V _{FB}	FB shorted to COMP	2.45	2.5	2.55	V
Input Bias Current	I _{B(FB)}			-0.01	-0.1	μA
Open-Loop Gain	A _{VOL}	2V ≤ V _{COMP} ≤ 4V		100		dB
Unity-Gain Bandwidth	f _{GBW}			1		MHz
Power-Supply Rejection Ratio	PSRR	12V ≤ V _{CC} ≤ 25V	60	80		dB
COMP Sink Current	I _{SINK}	V _{FB} = 2.7V, V _{COMP} = 1.1V	2	6		mA
COMP Source Current	I _{SOURCE}	V _{FB} = 2.3V, V _{COMP} = 5V	0.5	1.2	1.8	mA
COMP Output-Voltage High	V _{OH}	V _{FB} = 2.3V, R _{COMP} = 15kΩ to AGND	5	5.8		V
COMP Output-Voltage Low	V _{OL}	V _{FB} = 2.7V, R _{COMP} = 15kΩ to V _{REF}		0.1	1.1	V

Integrated 16-Channel LED Driver with Switch-Mode Boost and SEPIC Controller

MAX16809

ELECTRICAL CHARACTERISTICS (PWM CONTROLLER) (continued)

($V_{CC} = +15V$, $V_+ = +3V$ to $+5.5V$ referenced to PGND, $R_T = 10k\Omega$, $C_T = 3.3nF$, REF = open, COMP = open, $C_{REF} = 0.1\mu F$, $V_{FB} = 2V$, CS = AGND, AGND = PGND = 0V; all voltages are measured with respect to AGND, unless otherwise noted. $T_J = T_A = -40^\circ C$ to $+125^\circ C$, unless otherwise noted. Typical values are at $T_A = +25^\circ C$.) (Note 1)

PARAMETER	SYMBOL	CONDITIONS	MIN	TYP	MAX	UNITS	
CURRENT-SENSE AMPLIFIER							
Current-Sense Gain	ACS	(Notes 3, 4)	2.85	3	3.40	V/V	
Maximum Current-Sense Signal	VCS_MAX	(Note 3)	0.275	0.300	0.325	V	
Power-Supply Rejection Ratio	PSRR	$12V \leq V_{CC} \leq 25V$		70		dB	
Current-Sense Input Bias Current	ICS	$V_{COMP} = 0V$		-1	-2.5	μA	
Current Sense to OUT Delay	tpWM	50mV overdrive		60		ns	
MOSFET DRIVER							
OUT Low-Side On-Resistance	VRDS_ONL	ISINK = 200mA	T _J = -40°C to +85°C (Note 2)		4.5	10	Ω
			T _J = -40°C to +125°C		4.5	12	
OUT High-Side On-Resistance	VRDS_ONH	ISOURCE = 100mA	T _J = -40°C to +85°C (Note 2)		3.5	7.5	Ω
			T _J = -40°C to +125°C		3.5	10	
Source Current (Peak)	ISOURCE	CLOAD = 10nF		2		A	
Sink Current (Peak)	ISINK	CLOAD = 10nF		1		A	
Rise Time	tR	CLOAD = 1nF		15		ns	
Fall Time	tF	CLOAD = 1nF		22		ns	
UNDERVOLTAGE LOCKOUT/STARTUP							
Startup Voltage Threshold	VCC_START		7.98	8.4	8.82	V	
Minimum Operating Voltage After Turn-On	VCC_MIN		7.1	7.6	8.0	V	
Undervoltage-Lockout Hysteresis	UVLOHYST			0.8		V	
PULSE-WIDTH MODULATION (PWM)							
Maximum Duty Cycle	DMAX		94.5	96	97.5	%	
Minimum Duty Cycle	DMIN				0	%	
SUPPLY CURRENT							
Startup Supply Current	I _{START}	V _{CC} = 7.5V		32	65	μA	
Operating Supply Current	I _{CC}	V _{FB} = V _{CS} = 0V		3	5	mA	
V _{CC} Zener Voltage	V _Z	I _{CC} = 25mA	24	26.5		V	

Integrated 16-Channel LED Driver with Switch-Mode Boost and SEPIC Controller

ELECTRICAL CHARACTERISTICS (LED DRIVER)

(V+ = +3V to +5.5V, AGND = PGND = 0V; all voltages are measured with respect to PGND, unless otherwise noted. T_A = T_J = -40°C to +125°C, unless otherwise noted. Typical values are at T_A = +25°C.) (Note 1)

PARAMETER	SYMBOL	CONDITIONS	MIN	TYP	MAX	UNITS
Operating Supply Voltage	V+		3.0		5.5	V
Output Voltage	V _{OUT_}				36	V
Standby Current (Interface Idle, All Output Ports High Impedance)		R _{SET} = 360Ω, DIN, LE, CLK = PGND or V+, \overline{OE} = V+, DOUT unconnected		3.6	4.5	mA
Standby Current (Interface Active, All Output Ports High Impedance)		R _{SET} = 360Ω, f _{CLK} = 5MHz, \overline{OE} = V+, DIN, LE = PGND or V+, DOUT unconnected		3.8	4.8	mA
Supply Current (Interface Idle, All Output Ports Active Low)	I+	R _{SET} = 360Ω, \overline{OE} = PGND, DIN, LE = V+, DOUT unconnected		30	52.5	mA
INTERFACE (DIN, CLK, DOUT, LE, \overline{OE})						
Input-Voltage High (DIN, CLK, LE, \overline{OE})	V _{IH}		0.7 x V+			V
Input-Voltage Low (DIN, CLK, LE, \overline{OE})	V _{IL}				0.3 x V+	V
Hysteresis Voltage (DIN, CLK, LE, \overline{OE})	V _{HYST}			0.8		V
Input Leakage Current (DIN, CLK)	I _{LEAK}		-1		+1	μA
\overline{OE} Pullup Current to V+	I _{\overline{OE}}	V+ = 5.5V, \overline{OE} = PGND	0.25	1.5	25	μA
LE Pulldown Current to PGND	I _{LE}	V+ = 5.5V, LE = V+	0.25	1.5	25	μA
Output-Voltage High (DOUT)	V _{OH}	I _{SOURCE} = 4mA	V+ - 0.5V			V
Output-Voltage Low (DOUT)	V _{OL}	I _{SINK} = 4mA			0.5	V
OUT_ Output Current	I _{OUT_}	0°C ≤ T _A ≤ +125°C, V _{OUT} = 1V to 2.5V, R _{SET} = 360Ω	43.25	47.5	51.75	mA
		T _A = -40°C, V _{OUT} = 1V to 2.5V, R _{SET} = 360Ω	40		55	
OUT_ Leakage Current		\overline{OE} = V+			1	μA

Integrated 16-Channel LED Driver with Switch-Mode Boost and SEPIC Controller

MAX16809

5V TIMING CHARACTERISTICS

(V+ = +4.5V to +5.5V, AGND = PGND = 0V; all voltages are measured with respect to PGND, unless otherwise noted. T_A = T_J = -40°C to +125°C, unless otherwise noted. Typical values are at T_A = +25°C.) (Notes 1, 5)

PARAMETER	SYMBOL	CONDITION	MIN	TYP	MAX	UNITS
INTERFACE TIMING CHARACTERISTICS						
CLK Clock Period	t _{CP}		40			ns
CLK Pulse-Width High	t _{CH}		19			ns
CLK Pulse-Width Low	t _{CL}		19			ns
DIN Setup Time	t _{DS}		4			ns
DIN Hold Time	t _{DH}		8			ns
DOUT Propagation Delay	t _{DO}		10		50	ns
DOUT Rise Time	t _{DR}	C _{DOUT} = 10pF, 20% to 80%			10	ns
DOUT Fall Time	t _{DF}	C _{DOUT} = 10pF, 80% to 20%			10	ns
LE Pulse-Width High	t _{LW}		20			ns
LE Setup Time	t _{LS}		15			ns
LE Rising to OUT_ _ Rising Delay	t _{LRR}	(Note 6)			110	ns
LE Rising to OUT_ _ Falling Delay	t _{LRF}	(Note 6)			340	ns
CLK Rising to OUT_ _ Rising Delay	t _{CRR}	(Note 6)			110	ns
CLK Rising to OUT_ _ Falling Delay	t _{CRF}	(Note 6)			340	ns
$\overline{\text{OE}}$ Rising to OUT_ _ Rising Delay	t _{$\overline{\text{OE}}$R}	(Note 6)			110	ns
$\overline{\text{OE}}$ Falling to OUT_ _ Falling Delay	t _{$\overline{\text{OE}}$F}	(Note 6)			340	ns
OUT_ _ Turn-On Fall Time	t _F	80% to 20% (Note 6)			210	ns
OUT_ _ Turn-Off Rise Time	t _R	20% to 80% (Note 6)			130	ns

Integrated 16-Channel LED Driver with Switch-Mode Boost and SEPIC Controller

3.3V TIMING CHARACTERISTICS

(V₊ = +3V to < +4.5V, AGND = PGND = 0V; all voltages are measured with respect to PGND, unless otherwise noted. T_A = T_J = -40°C to +125°C, unless otherwise noted. Typical values are at T_A = +25°C.) (Notes 1, 5)

PARAMETERS	SYMBOL	CONDITIONS	MIN	TYP	MAX	UNITS
INTERFACE TIMING CHARACTERISTICS						
CLK Clock Period	t _{CP}		52			ns
CLK Pulse-Width High	t _{CH}		24			ns
CLK Pulse-Width Low	t _{CL}		24			ns
DIN Setup Time	t _{DS}		4			ns
DIN Hold Time	t _{DH}		8			ns
DOUT Propagation Delay	t _{DO}		12		70	ns
DOUT Rise Time	t _{DR}	C _{DOUT} = 10pF, 20% to 80%			12	ns
DOUT Fall Time	t _{DF}	C _{DOUT} = 10pF, 80% to 20%			12	ns
LE Pulse-Width High	t _{LW}		20			ns
LE Setup Time	t _{LS}		15			ns
LE Rising to OUT_ _ Rising Delay	t _{LRR}	(Note 6)			140	ns
LE Rising to OUT_ _ Falling Delay	t _{LRF}	(Note 6)			400	ns
CLK Rising to OUT_ _ Rising Delay	t _{CRR}	(Note 6)			140	ns
CLK Rising to OUT_ _ Falling Delay	t _{CRF}	(Note 6)			400	ns
$\overline{\text{OE}}$ Rising to OUT_ _ Rising Delay	t _{ÖER}	(Note 6)			140	ns
$\overline{\text{OE}}$ Falling to OUT_ _ Falling Delay	t _{ÖEF}	(Note 6)			400	ns
OUT_ _ Turn-On Fall Time	t _F	80% to 20% (Note 6)			275	ns
OUT_ _ Turn-Off Rise Time	t _R	20% to 80% (Note 6)			150	ns

Note 1: This device is 100% production tested at T_J = +25°C and +125°C. Limits to -40°C are guaranteed by design.

Note 2: Guaranteed by design, not production tested.

Note 3: Parameter is measured at trip point of latch with V_{FB} = 0V.

Note 4: Gain is defined as $A = \Delta V_{\text{COMP}}/\Delta V_{\text{CS}}$, $0.05V \leq V_{\text{CS}} \leq 0.25V$.

Note 5: See Figures 3 and 4.

Note 6: A 65Ω pullup resistor is connected from OUT_ _ to 5.5V. Rising refers to V_{OUT_ _} when current through OUT_ _ is turned off and falling refers to V_{OUT_ _} when current through OUT_ _ is turned on.

Integrated 16-Channel LED Driver with Switch-Mode Boost and SEPIC Controller

MAX16809

Typical Operating Characteristics

($V_{CC} = +15V$, $V_+ = 3V$ to $5.5V$, $R_T = 10k\Omega$, $C_T = 3.3nF$, $V_{REF} = COMP = open$, $C_{REF} = 0.1\mu F$, $V_{FB} = 2V$, $CS = AGND = PGND = 0V$. Typical values are at $T_A = +25^\circ C$, unless otherwise noted.)

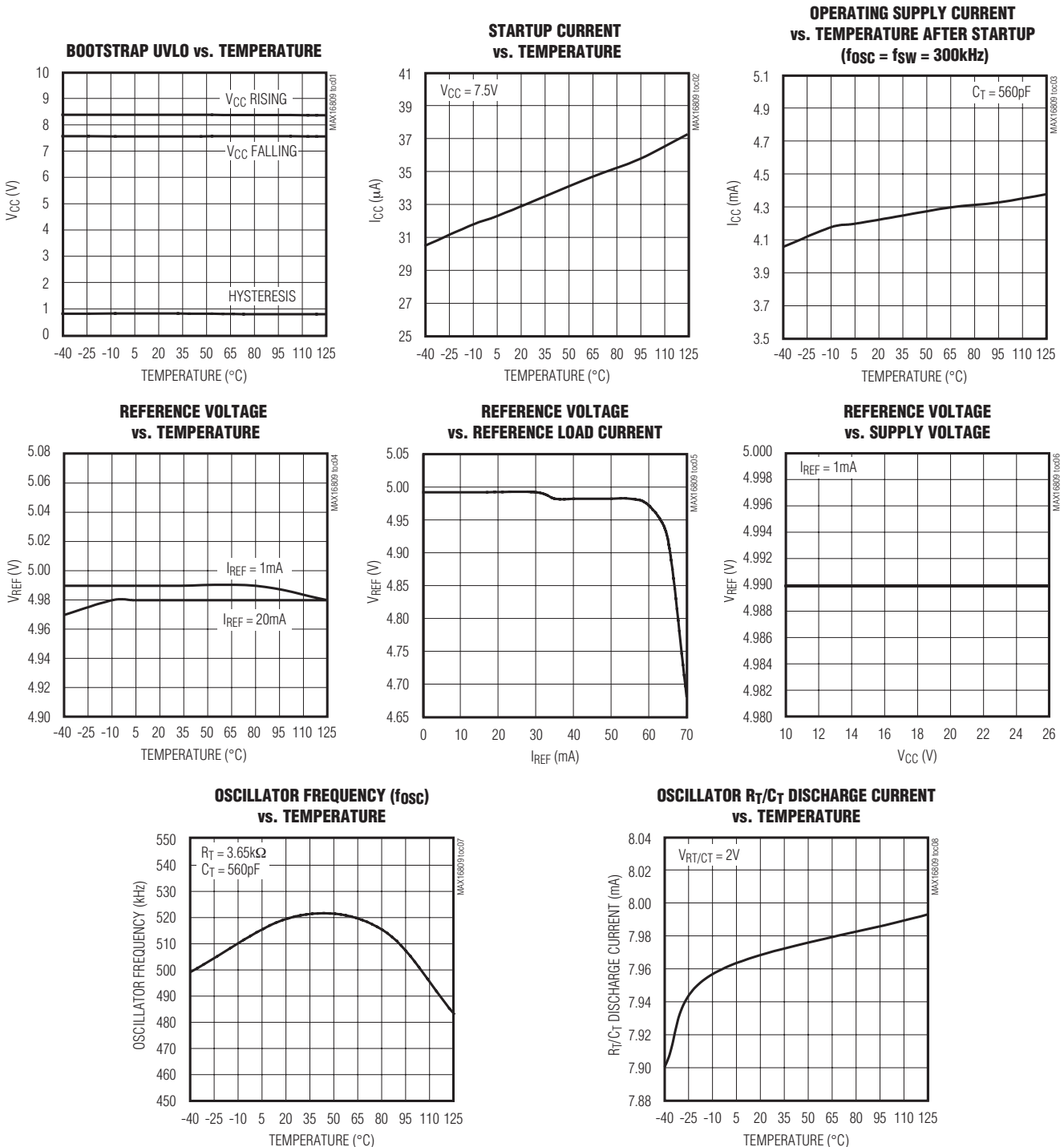

Integrated 16-Channel LED Driver with Switch-Mode Boost and SEPIC Controller

Typical Operating Characteristics (continued)

($V_{CC} = +15V$, $V_+ = 3V$ to $5.5V$, $R_T = 10k\Omega$, $C_T = 3.3nF$, $V_{REF} = COMP = open$, $C_{REF} = 0.1\mu F$, $V_{FB} = 2V$, $CS = AGND = PGND = 0V$. Typical values are at $T_A = +25^\circ C$, unless otherwise noted.)

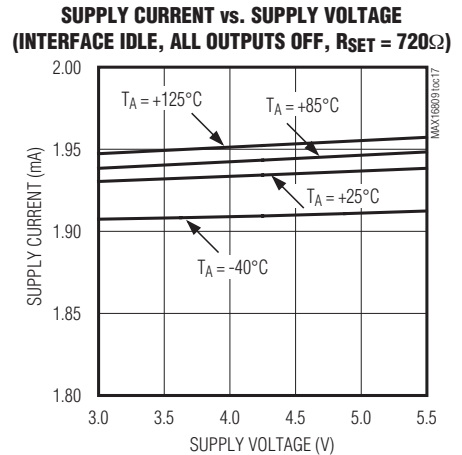
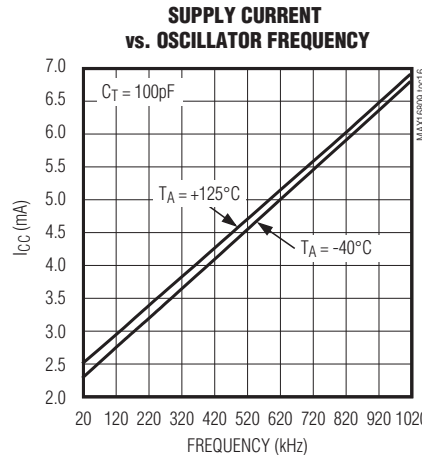
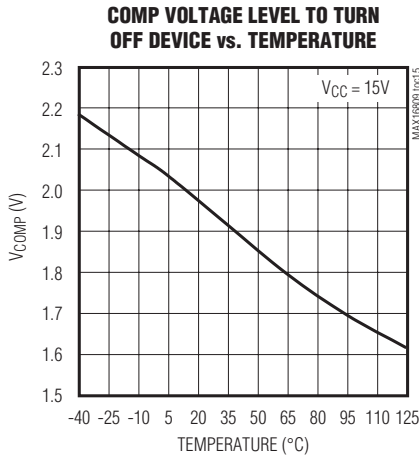
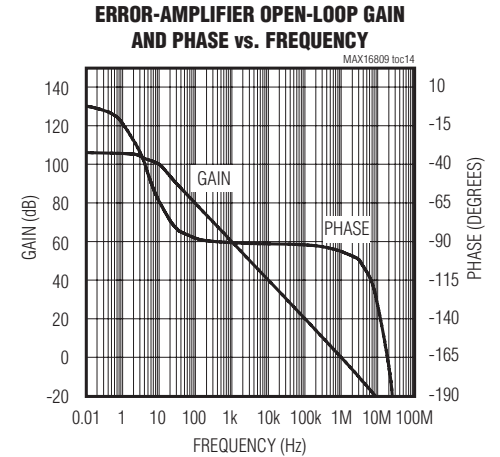
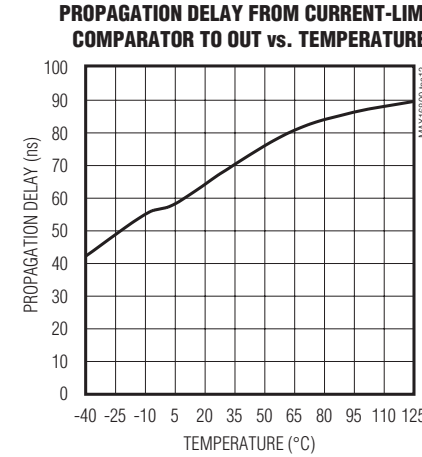
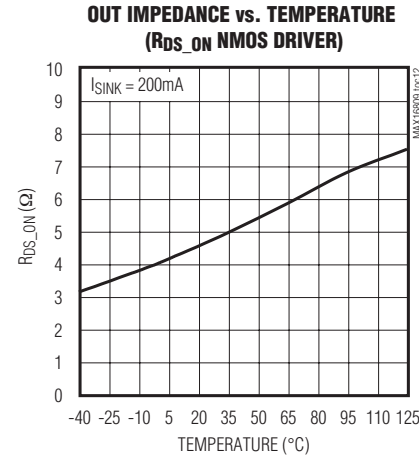
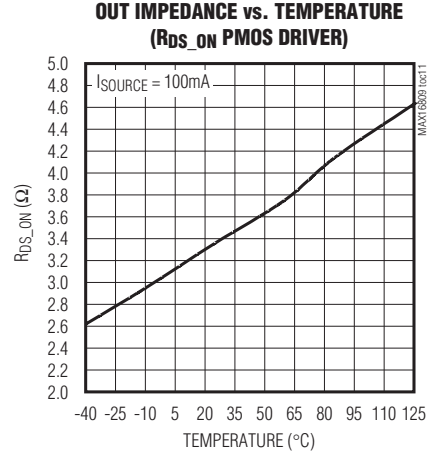
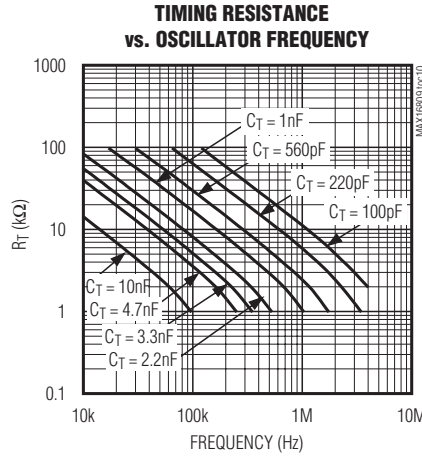
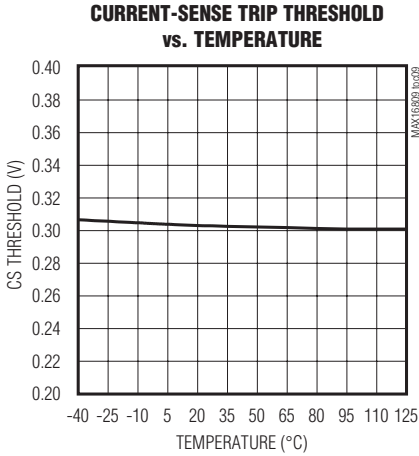

Integrated 16-Channel LED Driver with Switch-Mode Boost and SEPIC Controller

MAX16809

Typical Operating Characteristics (continued)

($V_{CC} = +15V$, $V_+ = 3V$ to $5.5V$, $R_T = 10k\Omega$, $C_T = 3.3nF$, $V_{REF} = COMP = open$, $C_{REF} = 0.1\mu F$, $V_{FB} = 2V$, $CS = AGND = PGND = 0V$. Typical values are at $T_A = +25^\circ C$, unless otherwise noted.)

SUPPLY CURRENT vs. SUPPLY VOLTAGE
(INTERFACE IDLE, ALL OUTPUTS OFF, $R_{SET} = 360\Omega$)

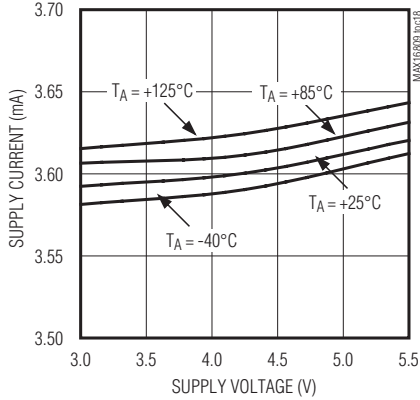

SUPPLY CURRENT vs. SUPPLY VOLTAGE
(INTERFACE IDLE, ALL OUTPUTS ON, $R_{SET} = 720\Omega$)

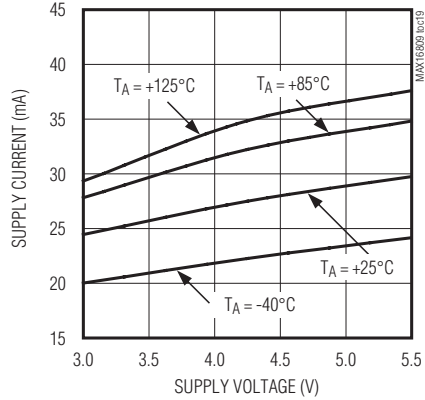

SUPPLY CURRENT vs. SUPPLY VOLTAGE
(INTERFACE IDLE, ALL OUTPUTS ON, $R_{SET} = 360\Omega$)

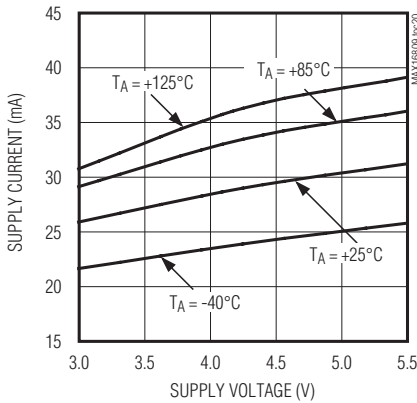

OUT_ _ CURRENT vs. OUT_ _ VOLTAGE
($R_{SET} = 720\Omega$, $V_+ = 3.3V$)

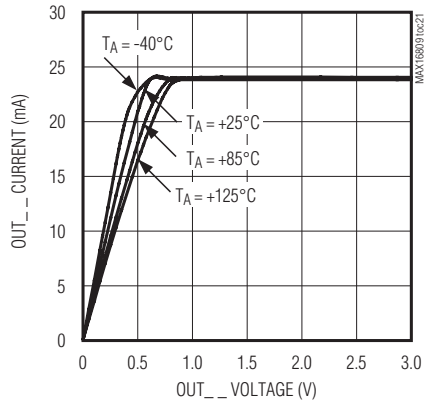

OUT_ _ CURRENT vs. OUT_ _ VOLTAGE
($R_{SET} = 360\Omega$, $V_+ = 3.3V$)

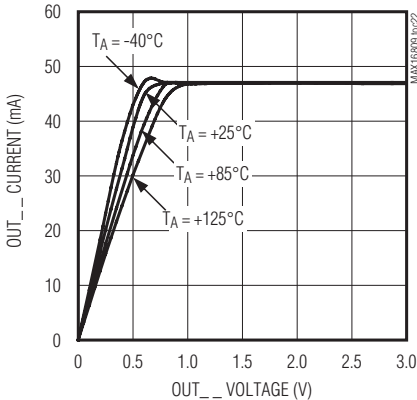

OUT_ _ CURRENT vs. OUT_ _ VOLTAGE
($R_{SET} = 720\Omega$, $V_+ = 5.0V$)

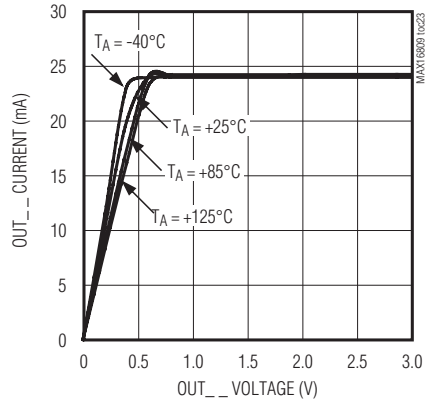

Integrated 16-Channel LED Driver with Switch-Mode Boost and SEPIC Controller

Typical Operating Characteristics (continued)

($V_{CC} = +15V$, $V_+ = 3V$ to $5.5V$, $R_T = 10k\Omega$, $C_T = 3.3nF$, $V_{REF} = COMP = open$, $C_{REF} = 0.1\mu F$, $V_{FB} = 2V$, $CS = AGND = PGND = 0V$. Typical values are at $T_A = +25^\circ C$, unless otherwise noted.)

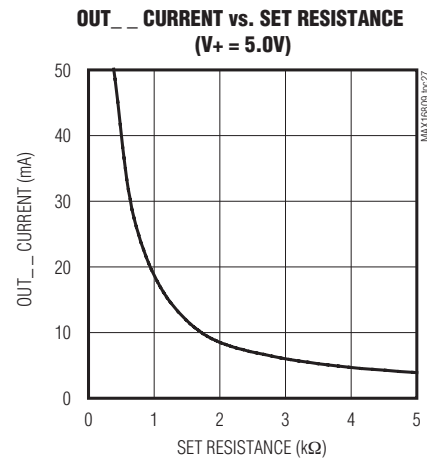
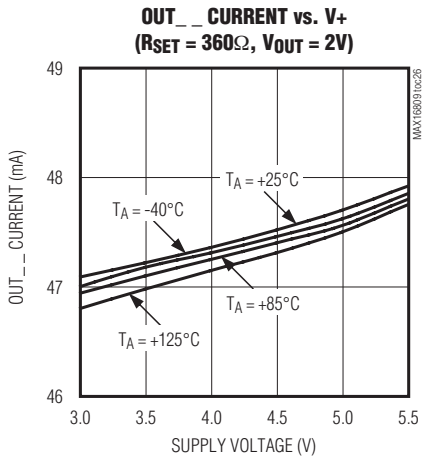
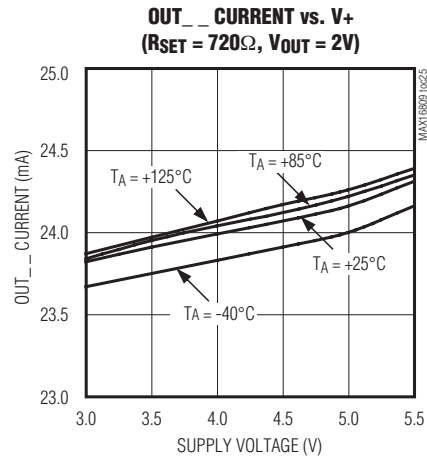
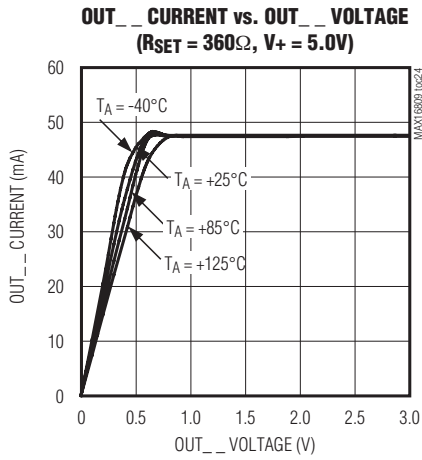

Integrated 16-Channel LED Driver with Switch-Mode Boost and SEPIC Controller

Pin Description

MAX16809

PIN	NAME	FUNCTION
1, 31, 32, 36, 38	N.C.	No Connection. Not internally connected. Leave unconnected.
2	FB	Error-Amplifier Inverting Input
3	COMP	Error-Amplifier Output
4–11	OUT8–OUT15	LED Driver Outputs. OUT8–OUT15 are open-drain, constant-current-sinking outputs rated for 36V.
12	\overline{OE}	Active-Low, Output Enable Input. Drive \overline{OE} low to PGND to enable the OUT0–OUT15. Drive \overline{OE} high to disable OUT0–OUT15.
13	DOUT	Serial-Data Output. Data is clocked out of the 16-bit internal shift register to DOUT on CLK's rising edge.
14	SET	LED Current Setting. Connect R _{SET} from SET to PGND to set the LED current.
15	V+	LED Driver Positive Supply Voltage. Bypass V+ to PGND with a 0.1μF ceramic capacitor.
16, 17	PGND	Power Ground
18	DIN	Serial-Data Input. Data is loaded into the internal 16-bit shift register on CLK's rising edge.
19	CLK	Serial-Clock Input
20	LE	Latch-Enable Input. Data is loaded transparently from the internal shift register(s) to the output latch(es) while LE is high. Data is latched into the output latch(es) on LE's falling edge, and retained while LE is low.
21–28	OUT0–OUT7	LED Driver Outputs. OUT0–OUT7 are open-drain, constant-current-sinking outputs rated for 36V.
29	RTCT	PWM Controller Timing Resistor/Capacitor Connection. A resistor R _T from RTCT to REF and a capacitor C _T from RTCT to AGND set the oscillator frequency.
30	CS	PWM Controller Current-Sense Input
33	AGND	Analog Ground
34	OUT	MOSFET Driver Output OUT. Connects to the gate of the external n-channel MOSFET.
35	V _{CC}	Power-Supply Input. Bypass V _{CC} to AGND with a 0.1μF ceramic capacitor or a parallel combination of a 0.1μF and a higher value ceramic capacitor.
37	REF	5V Reference Output. Bypass REF to AGND with a 0.1μF ceramic capacitor.
—	EP	Exposed Paddle. Connect to the ground plane for improved power dissipation. Do not use as the only ground connection.

Detailed Description

The MAX16809 LED driver includes an internal switch-mode controller that can be used as a boost or buck-boost (SEPIC) converter to generate the voltage necessary to drive the multiple strings of LEDs. This device incorporates an integrated low-side driver, a programmable oscillator (20kHz to 1MHz), an error amplifier, a low-voltage (300mV) current sense for higher efficiency, and a 5V reference to power up external circuitry (see Figures 1a and 1b).

The MAX16809 LED driver includes a 4-wire serial interface and a current-mode PWM controller to generate the necessary voltage for driving 16 open-drain, constant-current-sinking output ports. The driver uses

current-sensing feedback circuitry (not simple current mirrors) to ensure very small current variations over the full allowed range of output voltage (see the *Typical Operating Characteristics*). The 4-wire serial interface comprises a 16-bit shift register and a 16-bit transparent latch. The shift register is written through a clock input, CLK, and a data input, DIN, and the data propagates to a data output, DOUT. The data output allows multiple drivers to be cascaded and operated together. The contents of the 16-bit shift register are loaded into the transparent latch through a latch-enable input, LE. The latch is transparent to the shift register outputs when high and latches the current state on the falling edge of LE. Each driver output is an open-drain, constant-current sink that should be connected to the

Integrated 16-Channel LED Driver with Switch-Mode Boost and SEPIC Controller

cathode of a string of LEDs connected in series. The constant-current capability is up to 55mA per output, set for all 16 outputs by an external resistor, R_{SET}. The device can operate in a stand-alone mode (see the *Typical Operating Circuits*).

The number of channels can be expanded by using the MAX6970 and MAX6971 family in conjunction with the MAX16809.

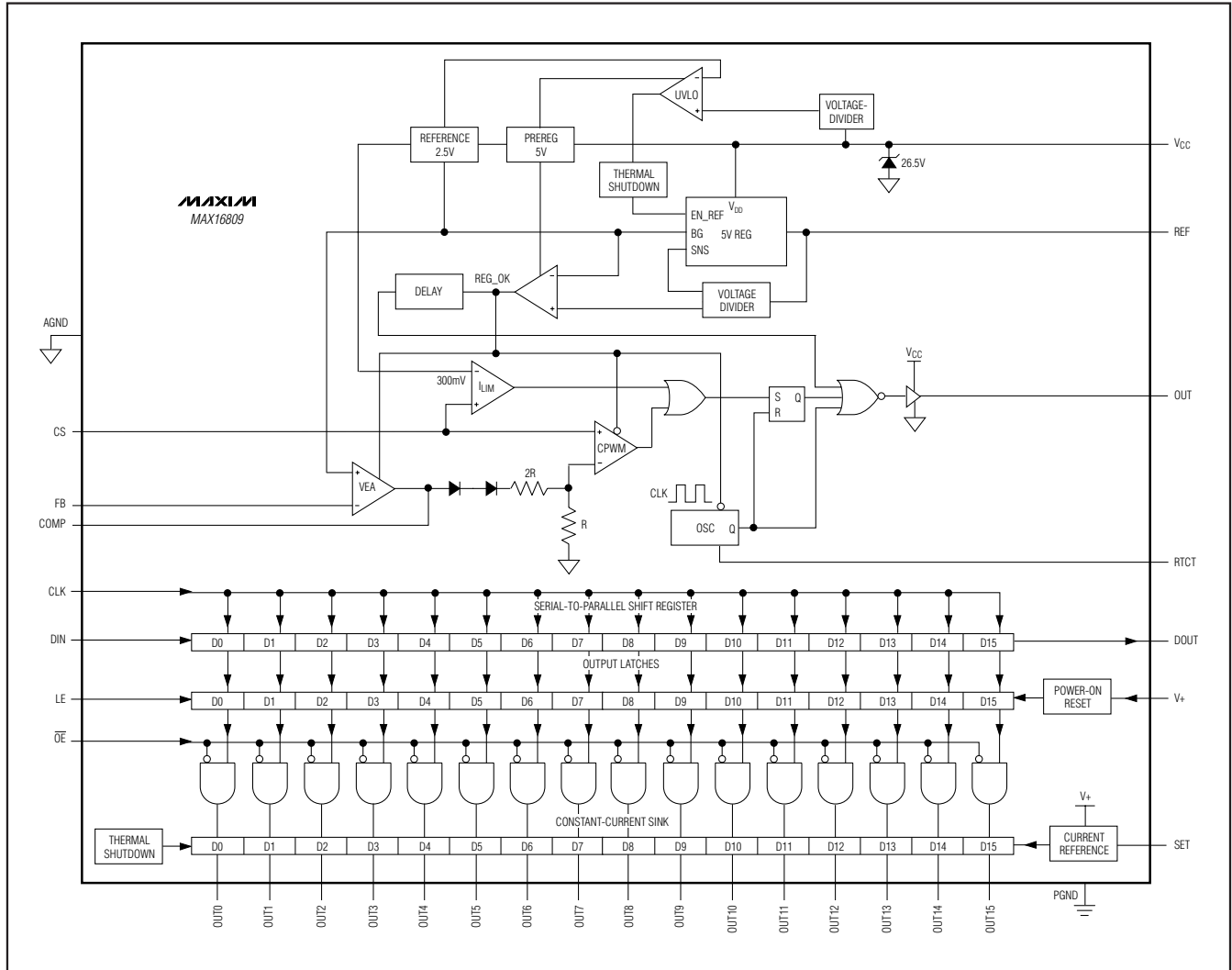

Figure 1a. Internal Block Diagram

Integrated 16-Channel LED Driver with Switch-Mode Boost and SEPIC Controller

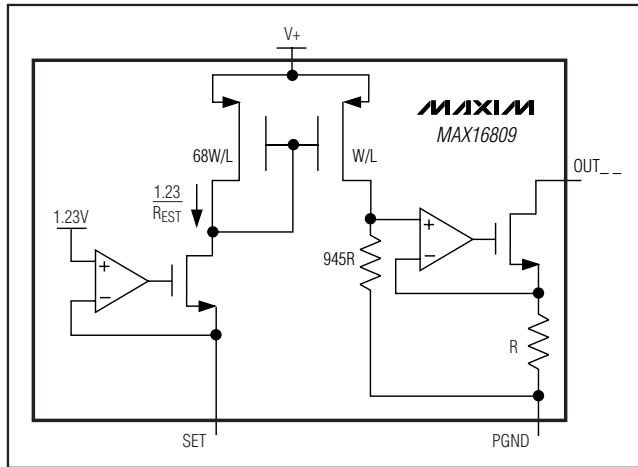

Figure 1b. OUT_ Driver Internal Diagram

Switch-Mode Controller

Current-Mode Control Loop

The advantages of current-mode control over voltage-mode control are twofold. First, there is the feed-forward characteristic brought on by the controller's ability to adjust for variations in the input voltage on a cycle-by-cycle basis. Second, the stability requirements of the current-mode controller are reduced to that of a single-pole system unlike the double pole in the voltage-mode control scheme. The MAX16809 uses a current-mode control loop where the output of the error amplifier is compared to the current-sense voltage (V_{CS}). When the current-sense signal is lower than the inverting input of the CPWM comparator, the output of the comparator is low and the switch is turned on at each clock pulse. When the current-sense signal is higher than the inverting input of the CPWM comparator, the output is high and the switch is turned off.

Undervoltage Lockout (UVLO)

The turn-on supply voltage for the MAX16809 is 8.4V (typ). Once V_{CC} reaches 8.4V, the reference powers up. There is a 0.8V of hysteresis from the turn-on voltage to the UVLO threshold. Once V_{CC} reaches 8.4V, the MAX16809 operates with V_{CC} down to 7.6V. Once V_{CC} goes below 7.6V (typ), the device is in UVLO. When in UVLO, the quiescent supply current into V_{CC} falls back to 32 μ A (typ), and OUT and REF are pulled low.

MOSFET Driver

OUT drives an external n-channel MOSFET and swings from AGND to V_{CC} . Ensure that V_{CC} remains below the absolute maximum V_{GS} rating of the external MOSFET. OUT is a push-pull output with the on-resistance of the

pMOS typically 3.5 Ω and the on-resistance of the nMOS typically 4.5 Ω . The driver can source 2A and sink 1A typically. This allows for the MAX16809 to quickly turn on and off high gate-charge MOSFETs. Bypass V_{CC} with one or more 0.1 μ F ceramic capacitors to AGND, placed close to V_{CC} . The average current sourced to drive the external MOSFET depends on the total gate charge (Q_G) and operating frequency of the converter. The power dissipation in the MAX16809 is a function of the average output drive current (I_{DRIVE}). Use the following equation to calculate the power dissipation in the device due to I_{DRIVE} :

$$I_{DRIVE} = (Q_G \times f_{SW})$$

$$PD = (I_{DRIVE} + I_{CC}) \times V_{CC}$$

where I_{CC} is the operating supply current. See the *Typical Operating Characteristics* for the operating supply current at a given frequency.

Error Amplifier

The MAX16809 includes an internal error amplifier. The inverting input is at FB and the noninverting input is internally connected to a 2.5V reference. Set the output voltage using a resistive divider between output of the converter V_{OUT} , FB, and AGND. Use the following formula to set the output voltage:

$$V_{OUT} = \left(1 + \frac{R_1}{R_2}\right) \times V_{FB}$$

where $V_{FB} = 2.5V$.

Oscillator

The oscillator frequency is programmable using an external capacitor and a resistor at RTCT (see R_T and C_T in the *Typical Operating Circuits*). R_T is connected from RTCT to the 5V reference (REF), and C_T is connected from RTCT to AGND. REF charges C_T through R_T until its voltage reaches 2.8V. C_T then discharges through an 8.3mA internal current sink until C_T 's voltage reaches 1.1V, at which time C_T is allowed to charge through R_T again. The oscillator's period is the sum of the charge and discharge times of C_T . Calculate the charge time as follows:

$$t_C = 0.57 \times R_T \times C_T$$

where t_C is in seconds, R_T in ohms (Ω), and C_T in Farads (F).

The discharge time is then:

$$t_D = (R_T \times C_T \times 1000) / [(4.88 \times R_T) - (1.8 \times 1000)]$$

where t_D is in seconds, R_T in ohms (Ω), and C_T in Farads (F).

Integrated 16-Channel LED Driver with Switch-Mode Boost and SEPIC Controller

The oscillator frequency is then:

$$f_{OSC} = \frac{1}{(t_C + t_D)}$$

$$R_{CS} = \frac{V_{CS}}{I_{P-P}}$$

I_{P-P} is the peak current that flows through the MOSFET. When the voltage produced by this current (through the current-sense resistor) exceeds the current-limit comparator threshold, the MOSFET driver (OUT) turns the switch off within 60ns. In most cases, a small RC filter is required to filter out the leading-edge spike on the sense waveform. Set the time constant of the RC filter at 50ns.

Reference Output

REF is a 5V reference output that can source 20mA. Bypass REF to AGND with a 0.1µF capacitor.

Current Limit

The MAX16809 includes a fast current-limit comparator to terminate the ON cycle during an overload or a fault condition. The current-sense resistor, R_{CS} , connected between the source of the external MOSFET and AGND, sets the current limit. The CS input has a voltage trip level (V_{CS}) of 0.3V. Use the following equation to calculate R_{CS} :

Buck-Boost (SEPIC) Operation

Figure 2 shows a buck-boost application circuit using the MAX16809 in a stand-alone mode of operation. SEPIC topology is necessary when the total forward voltage of the LEDs in a string is such that V_{OUT} can be below or above V_{IN} .

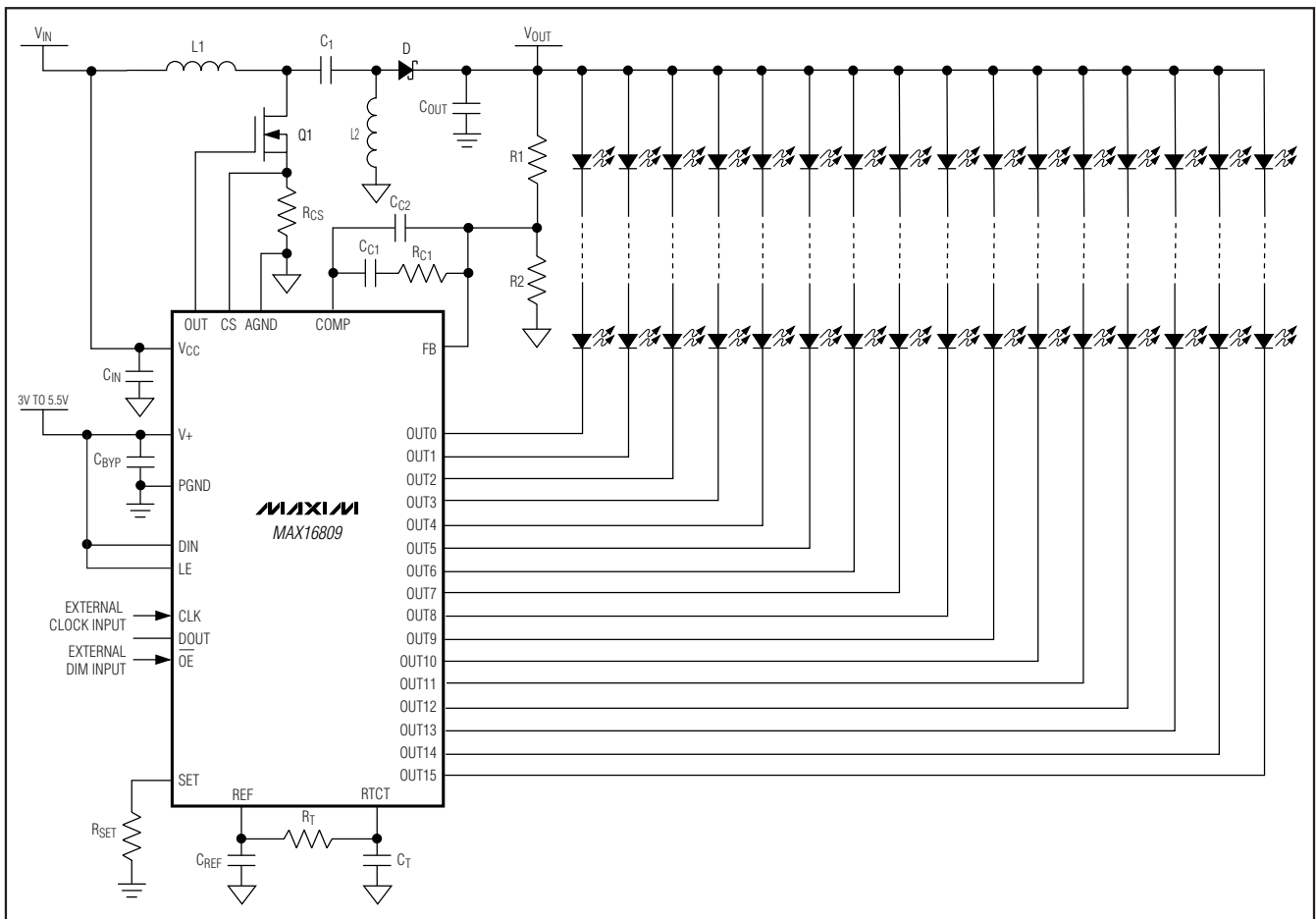

Figure 2. Buck-Boost (SEPIC) Operation

Integrated 16-Channel LED Driver with Switch-Mode Boost and SEPIC Controller

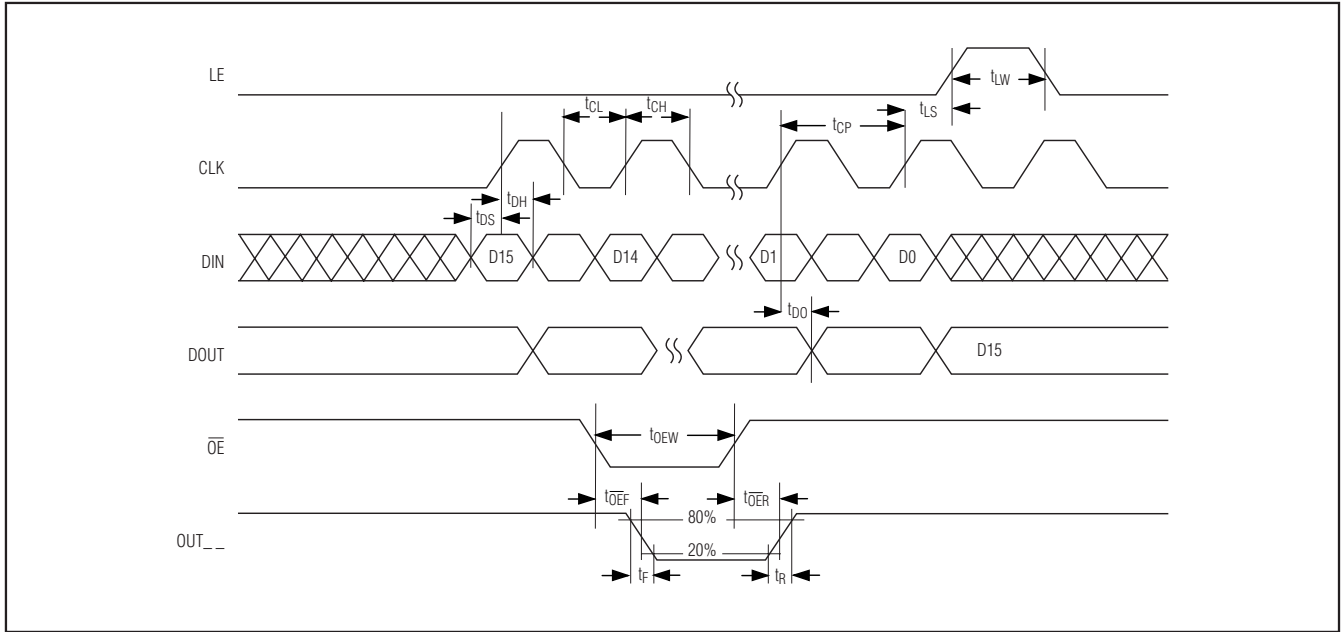

Figure 3. 4-Wire Serial-Interface Timing Diagram

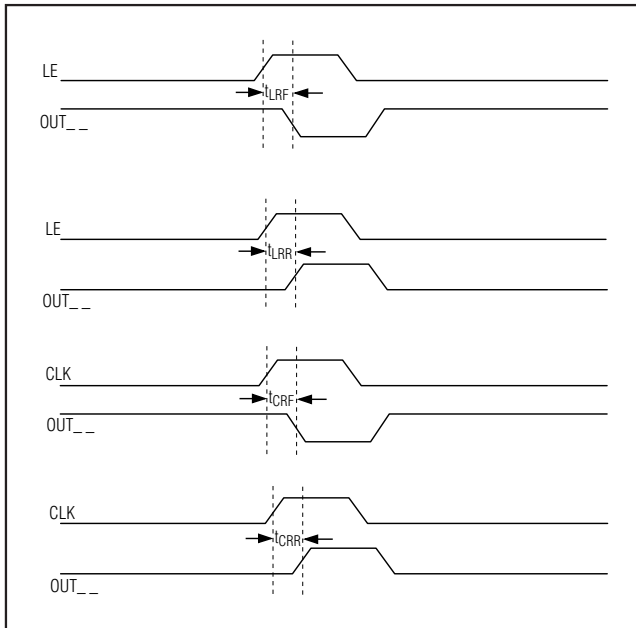

Figure 4. LE and CLK to OUT_ Timing

Selecting External Component R_{SET} to Set LED Output Current

The MAX16809 uses an external resistor, R_{SET}, to set the LED current for outputs OUT₀–OUT₁₅. The minimum allowed value of R_{SET} is 311Ω, which sets the output currents to 55mA. The maximum allowed value of R_{SET} is 5kΩ (I_{OUT_} = 3.6mA) and the maximum allowed capacitance at SET is 100pF.

Use the following formula to set the output current:

$$R_{SET} = \frac{17,100V}{I_{OUT_}}$$

where I_{OUT_} is the desired output current in milliamps and the value for R_{SET} is in ohms.

Overtemperature Cutoff

The MAX16809 contains an internal temperature sensor that turns off all outputs when the die temperature exceeds +165°C. The outputs are enabled again when the die temperature drops below +140°C. Register contents are not affected, so when a driver is overdissipating, the external symptom is the load LEDs cycling on and off as the driver repeatedly overheats and cools, alternately turning itself off and then back on again.

Integrated 16-Channel LED Driver with Switch-Mode Boost and SEPIC Controller

Stand-Alone Operation

In stand-alone operation, the MAX16809 does not use the 4-wire interface (see the *Typical Operating Circuits*). Connect DIN and LE to V+ and provide at least 16 external clock pulses to CLK to enable 16 output ports. This startup pulse sequence can be provided either using an external clock or the PWM signal. The external clock can also be generated using the signal at RTCT and an external comparator.

LED Dimming

PWM Dimming

All the output channels can be dimmed simultaneously by applying a PWM signal (50Hz to 30kHz) to \overline{OE} . This allows for a wide range of dimming up to a 5000:1 ratio. Each channel can be independently turned on and off using a 4-wire serial interface. The dimming is proportional to the PWM duty cycle.

LED Current Amplitude Adjustment

Using an analog or digital potentiometer as R_{SET} allows for LED current amplitude adjustment and linear dimming.

Computing Power Dissipation

Use the following equation to estimate the upper limit power dissipation (PD) for the MAX16809:

$$PD = DUTY \times \left[(V_+ \times I_+) + \sum_{i=0}^{i=15} V_{OUTi} \times I_{OUTi} \right] + (V_{CC} \times I_{CC})$$

where:

V₊ = supply voltage

I₊ = V₊ operating supply current

DUTY = PWM duty cycle applied to \overline{OE}

V_{OUTi} = MAX16809 port output voltage when driving load LED(s)

I_{OUTi} = LED drive current programmed by R_{SET}

PD = power dissipation

PCB Layout Guidelines

Careful PCB layout is critical to achieve low switching losses and clean, stable operation. Use a multilayer board whenever possible for better noise immunity. Protect sensitive analog grounds by using a star ground configuration. Minimize ground noise by connecting AGND, PGND, the input bypass-capacitor ground lead, and the output-filter ground lead to a single point (star ground configuration). Also, minimize trace lengths to reduce stray capacitance, trace resistance, and radiated noise. The trace between the output voltage-divider and the FB pin must be kept short, as well as the trace between AGND and PGND.

Integrated 16-Channel LED Driver with Switch-Mode Boost and SEPIC Controller

Typical Operating Circuits (continued)

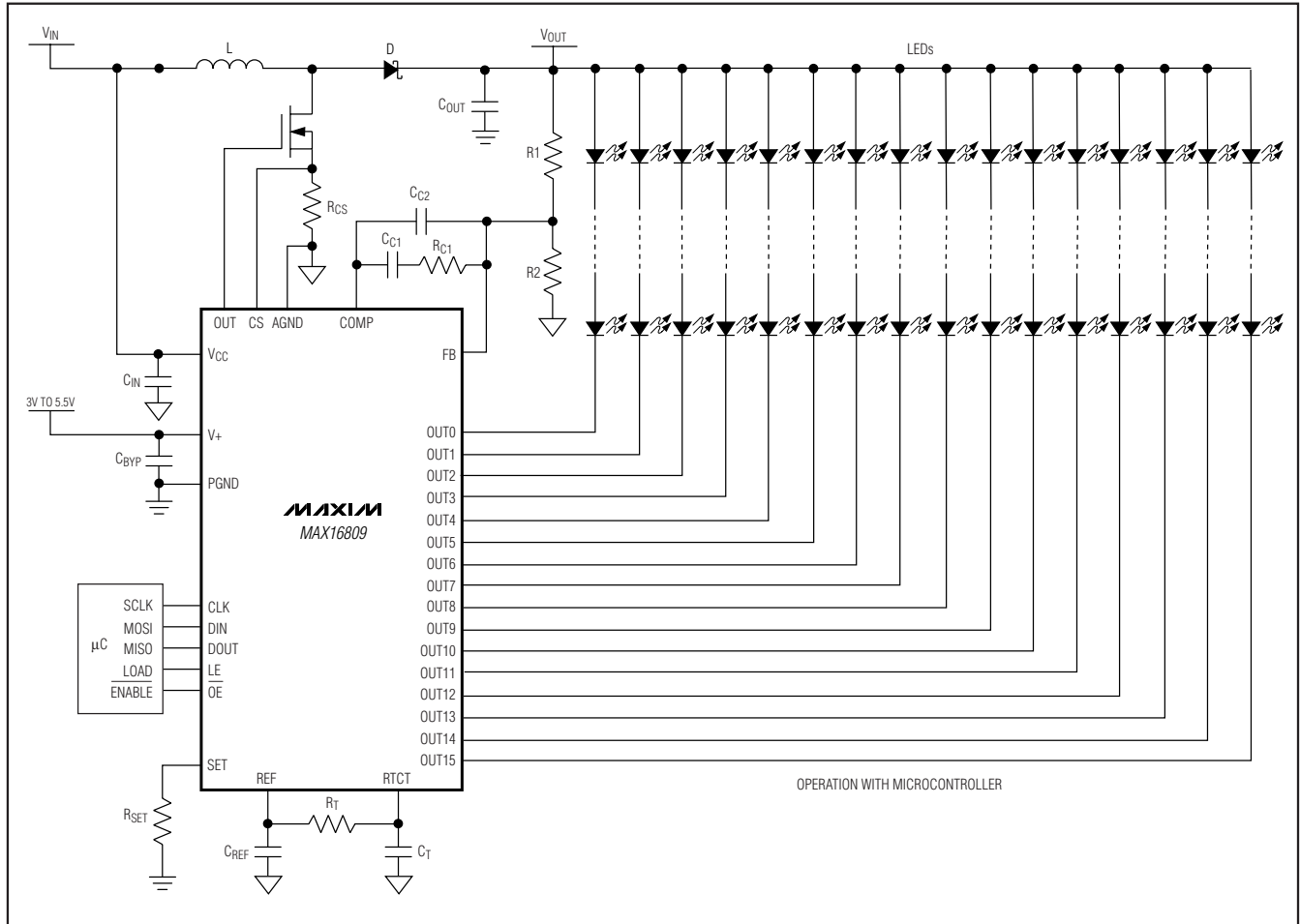

Integrated 16-Channel LED Driver with Switch-Mode Boost and SEPIC Controller

Pin Configuration

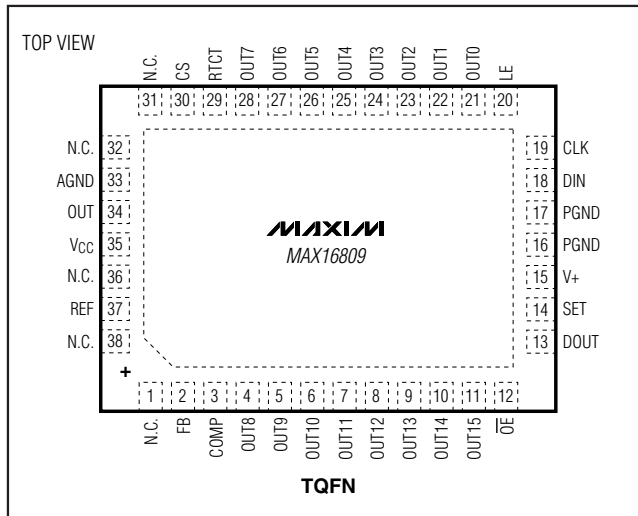

Chip Information

PROCESS: BiCMOS

Package Information

For the latest package outline information and land patterns, go to www.maxim-ic.com/packages. Note that a "+", "#", or "-" in the package code indicates RoHS status only. Package drawings may show a different suffix character, but the drawing pertains to the package regardless of RoHS status.

PACKAGE TYPE	PACKAGE CODE	DOCUMENT NO.
38 TQFN-EP	T3857-1	21-0172

MAX16809

Integrated 16-Channel LED Driver with Switch-Mode Boost and SEPIC Controller

Revision History

REVISION NUMBER	REVISION DATE	DESCRIPTION	PAGES CHANGED
0	10/06	Initial release	—
1	3/07	Released the MAX16810 on the data sheet.	1, 14, 16, 22, 23
2	8/09	Removed the MAX16810 from the data sheet.	1–20

Maxim cannot assume responsibility for use of any circuitry other than circuitry entirely embodied in a Maxim product. No circuit patent licenses are implied. Maxim reserves the right to change the circuitry and specifications without notice at any time.

20 _____ **Maxim Integrated Products, 120 San Gabriel Drive, Sunnyvale, CA 94086 408-737-7600**

© 2009 Maxim Integrated Products

Maxim is a registered trademark of Maxim Integrated Products, Inc.