



## Dual-Output RGB / 6-Channel WLED Driver with LED-Sense™ Temperature & Color Compensation

### FEATURES

- Six PowerLite™ Linear LDO current drivers with 25 mV drop-out in a common cathode topology with up to 25 mA per channel
- LED current programmable from 0 to 25 mA in 200 linear steps
- Three separately controlled driver banks (2 LED each) supports RGB LED applications.
- Integrated digital temperature sensor with 10-bit ADC; 1°C resolution with 5°C accuracy
- LED-Sense™\* temperature compensation algorithm continually monitors LED V-I parameters and adjusts brightness per user loaded PWM correction
- Three integrated PWM generators support RGB color correction and dimming with 12-bit resolution and 256 user programmable logarithmic steps (~ 0.17 dB per step)
- I<sup>2</sup>C serial programming interface; additional address pin allows 4 unique slave addresses.
- Power efficiency up to 98%; average efficiency > 80% in Li-ion battery applications
- Low current shutdown mode (< 1 µA); Low current software “standby mode” (< 5 µA)
- Soft start and current limiting
- LED Short circuit detection and protection, LED open detection
- Thermal shutdown protection
- Low EMI.
- Available in 3 x 3 x 0.8 mm<sup>3</sup> 16-pin TQFN or ultra small WCSP 3 x 4 ball grid (0.4mm pitch).

### APPLICATION

- Keypad and Display Backlight
- Cellular Phones
- Digital Still Cameras
- PDAs and Smartphones

### DESCRIPTION

The LDS8160 is a dual-output RGB or 6-channel white LED driver with three temperature compensation circuits for each bank of two LED drivers. It supports both RGB LED and WLED backlighting and keypad in portable applications.

Three 8-bit DACs set the current level for each LED bank (A, B, & C) from 0 to 25mA in 0.125mA steps.

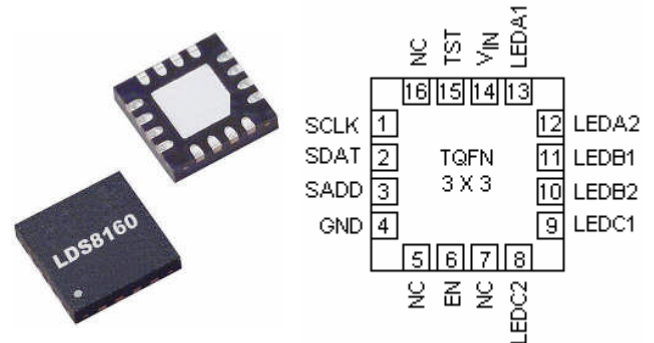

Each channel contains a linear LDO current driver in a common cathode (i.e., current source) topology.

The LDO drivers have a typical dropout voltage of 25mV at maximum rated current. This provides a low power and low EMI solution in Li-ion battery applications without voltage boosting and associated external capacitors and components.

Three 12-bit PWM generators with “smooth” logarithmic control support Temperature vs. LED Luminosity adjustments as well, as RGB color correction and dimming. The PWM generators are programmable via an I<sup>2</sup>C serial interface. User programmed 8-bit codes are converted to 12-bit resolution logarithmic steps of ~ 0.17 dB per step. The PWM frequency is ~280 Hz to minimize noise.

The LED-Sense™ temperature compensation engine includes a multiplexed 10-bit ADC and digital processing circuits. The algorithm continually measures the V-I characteristics of the LEDs and an on-chip temperature diode to determine LED junction temperatures to within 5°C accuracy.

Three user-programmable temperature correction tables (LUTs) store PWM adjustment codes for every 5°C increment from -35°C to 120°C. These codes drive the PWM engine to adjust for luminosity variations and/or high temperature current de-rating. The three correction LUTs support independent correction for 3-color RGB applications.

The EN logic input functions as a chip enable. A logic HIGH applied at EN allows the LDS8160 to respond to I<sup>2</sup>C communication. A serial address pin, SADD, supports use in multi-target applications. The device operates from 2.3V to 5.5V.

The LDS8160 is available in a 0.4mm pitch 12-ball WCSP or a 3 x 3 x 0.8 mm 16-lead TQFN packages.

## TYPICAL APPLICATION CIRCUIT

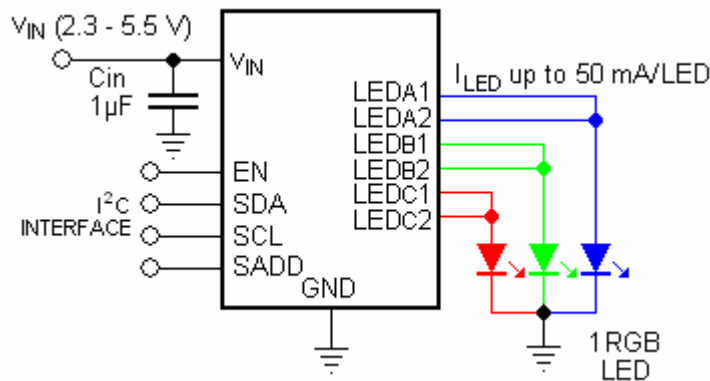
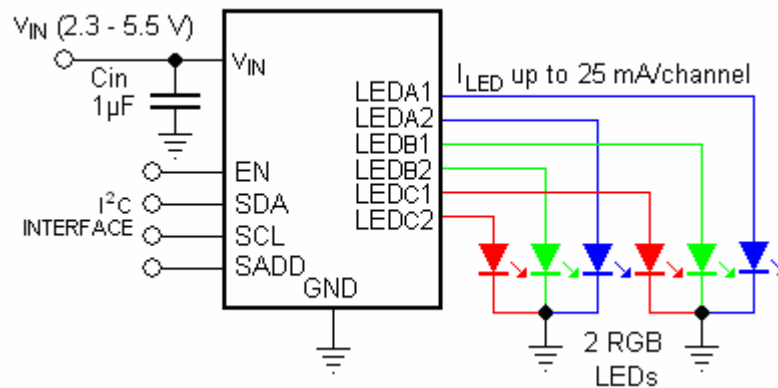
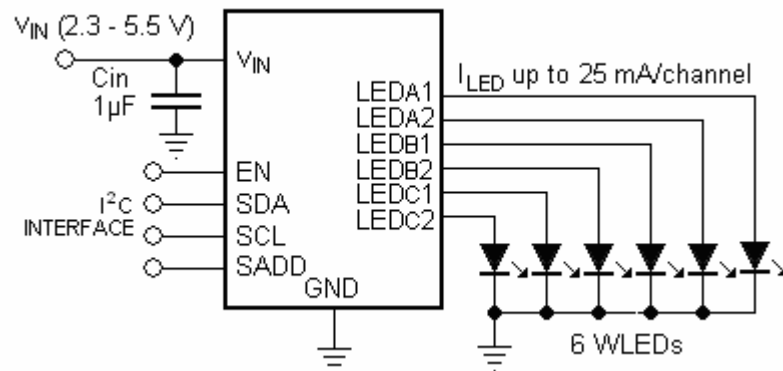

## ABSOLUTE MAXIMUM RATINGS

Parameter		Rating	Unit
V <sub>IN</sub> , LEDx		6	V
EN, SDAT, SCLK voltage		V <sub>IN</sub> + 0.7V	V
Storage Temperature Range		-65 to +160	°C
Junction Temperature Range		-40 to +125	°C
Soldering Temperature		300	°C
ESD Protection Level	HBM	2	kV
	MM	200	V

## RECOMMENDED OPERATING CONDITIONS

Parameter	Rating	Unit
V <sub>IN</sub>	2.3 to 5.5	V
I <sub>LED</sub> per LED pin	0 – 25	mA
Total Output Current I <sub>LOAD</sub>	150	mA
Junction Temperature Range	-40 to +125	°C
EN pin Input Voltage @ LP Standby Mode	1.8 ± 0.1	V

Typical application circuit with external components is shown on page 1.

## ELECTRICAL OPERATING CHARACTERISTICS

(Over recommended operating conditions unless specified otherwise) V<sub>in</sub> = 3.6V, C<sub>in</sub> = 1 μF, EN = High, T<sub>AMB</sub> = 25°C

Name		Conditions	Min	Typ	Max	Units
Quiescent Current	EN = 1.8 V	LP Standby (no I <sup>2</sup> C clock)		5		μA
	EN = V <sub>IN</sub>	Standby (no I <sup>2</sup> C clock)		125		μA
	6 Channels at 100% DC PWMs and Temp Compensations Active	I <sub>LOAD</sub> = 120 mA			0.6	
I <sub>LOAD</sub> = 60 mA				0.4		mA
Shutdown Current		V <sub>EN</sub> = 0V		0.5	1	μA
LED Current Accuracy		5mA ≤ I <sub>LED</sub> ≤ 25 mA		±1.5		%
LED Channel Matching		(I <sub>LED</sub> - I <sub>LEDAVG</sub> ) / I <sub>LEDAVG</sub>		±1.5		%
Line Regulation		2.7 V ≤ V <sub>IN</sub> ≤ 4.2 V		2		%/V
Load Regulation <sup>1</sup>		0.2 V < V <sub>dx</sub> < V <sub>IN</sub> - 1.4 V		0.8		%/V
Dropout Voltage <sup>2</sup>		5 mA ≤ I <sub>LED</sub> ≤ 25 mA	10	25	40	mV
PWM Frequency				285		Hz
# of PWM duty cycle steps		Log & Linear Mode		256		
Minimum PWM On Time				13.7		μs
PWM resolution		Log Mode		12		bits
		Linear Mode		8		bits
PWM Step Size		Log Mode		0.17		dB
		Linear Mode		I <sub>LED</sub> /256		
# of ΔPWM Adjustment Steps		1-x Scale Mode (~ 0.17 dB per step)	-7		+7	PWM Steps/5 <sup>0</sup> C
		2-x Scale Mode (~ 0.34 dB per step)	-7		+7	
Temperature Measurement Resolution				1		°C
Temperature Measurement Accuracy				5		°C
EN Pin	Input current		Active mode, EN = V <sub>IN</sub>	-1	1	μA
	LP Standby					
	Logic Level	High	Active Mode or Normal Standby Mode	1.2		0.4
Low						
Input Current Limit				450		mA
Thermal Shutdown				150		°C

Name	Conditions	Min	Typ	Max	Units
Thermal Hysteresis			20		
Wake-up Delay Time (EN Raising Edge)	Soft Ramp Disabled		0.5		ms
Shutdown Delay Time (EN Falling Edge)			10		
LED Driver PWM Ramp-Up time (from PWM write command via I <sup>2</sup> C)	Soft Ramping Enabled (only wake-up)		250		ms
Output short circuit Threshold <sup>3</sup>	I <sub>LED</sub> = 20 mA		0.14		V

- Note:**
1.  $V_{dx} = V_{in} - V_F$ ,
  2.  $V_{dx} = V_{in} - V_F$ , at which  $I_{LED}$  decreases by 10% from set value
  3. Minimum LED forward voltage, which will be interpreted as "LED SHORT" condition

## I<sup>2</sup>C CHARACTERISTICS

Over recommended operating conditions unless otherwise specified for  $2.7 \leq V_{IN} \leq 5.5V$ , over full ambient temperature range -40 to +85°C.

Symbol	Parameter	Min	Max	Unit
$f_{SCL}$	SCL Clock Frequency	0	400	kHz
$t_{HD:STA}$	Hold Time (repeated) START condition	0.6		$\mu s$
$t_{LOW}$	LOW period of the SCL clock	1.3		$\mu s$
$t_{HIGH}$	HIGH period of the SCL clock	0.6		$\mu s$
$t_{SU:STA}$	Set-up Time for a repeated START condition	0.6		$\mu s$
$t_{HD:DAT}$	Data In Hold Time	0	0.9	$\mu s$
$t_{SU:DAT}$	Data In Set-up Time	100		ns
$t_R$	Rise Time of both SDAT and SCLK signals		300	ns
$t_F$	Fall Time of both SDAT and SCLK signals		300	ns
$t_{SU:STO}$	Set-up Time for STOP condition	0.6		$\mu s$
$t_{BUF}$	Bus Free Time between a STOP and START condition	1.3		$\mu s$
$t_{AA}$	SCLK Low to SDAT Data Out and ACK Out		0.9	$\mu s$
$t_{DH}$	Data Out Hold Time	300		ns

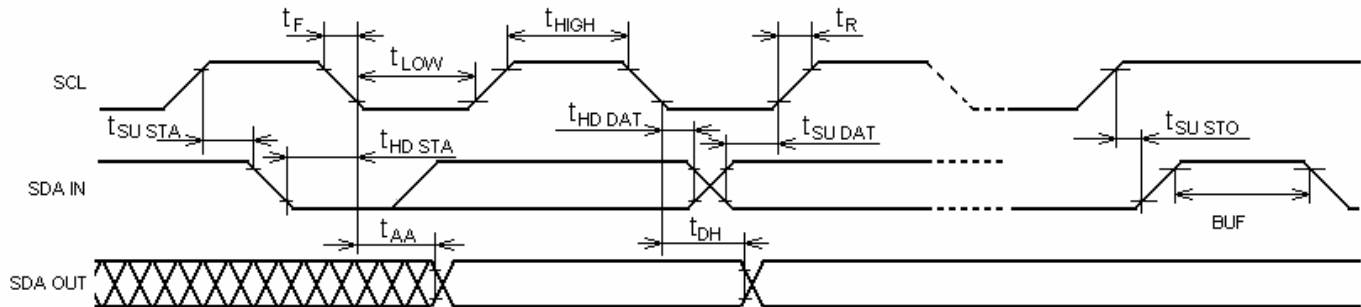
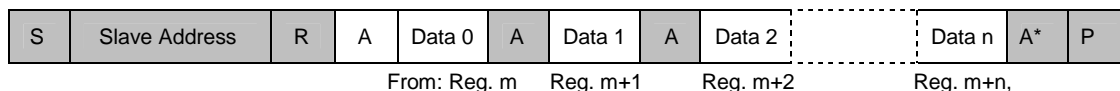

Figure 1: I<sup>2</sup>C Bus Timing Diagram

### READ OPERATION:

**Option 1:** Standard protocol sequential read:



where Reg. m is the last addressed in the write operation register

**Option 2:** Random access:

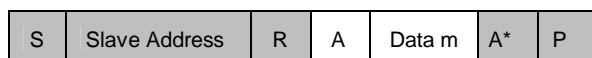

From reg. m, where Reg. m is the last addressed in the write operation register

**Option 3:** Random access with combined (extended) protocol:

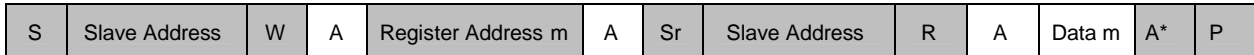

**WRITE OPERATION:**

**Option 1:** Standard protocol sequential write:

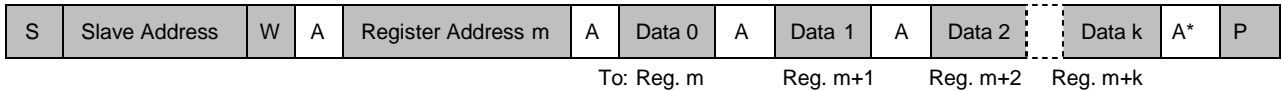

At k = 4 data are send to register m and cycle repeats

**Option 2:** Combined (extended) protocol:

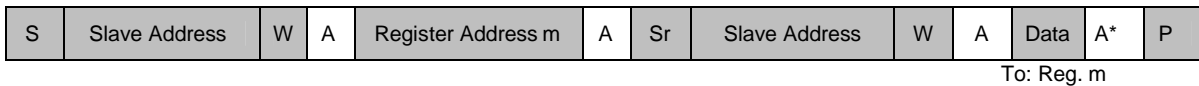

- S: Start Condition
- Sr Start Repeat Condition
- R, W: Read bit (1), Write bit (0)
- A: Acknowledge (SDAT high)
- A\*: Not Acknowledge (SDAT low)
- P: Stop Condition
- Slave Address: Device address 7 bits (MSB first).
- Register Address: Device register address 8 bits
- Data: Data to read or write 8 bits
- send by master
- send by slave

## I<sup>2</sup>C BUS PROTOCOL

Standard protocol

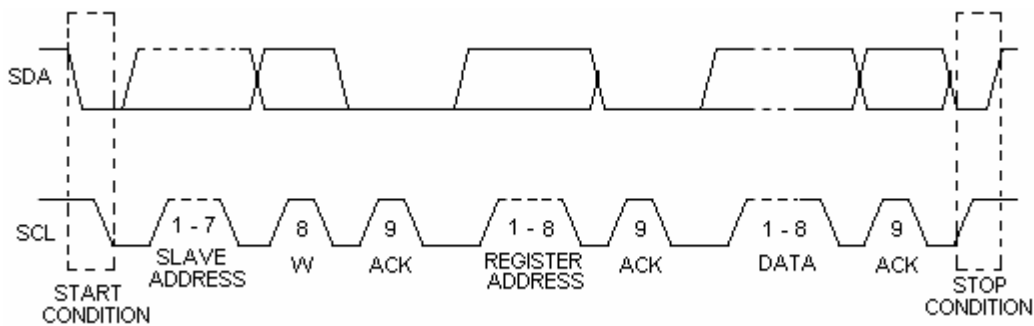

Combined protocol:

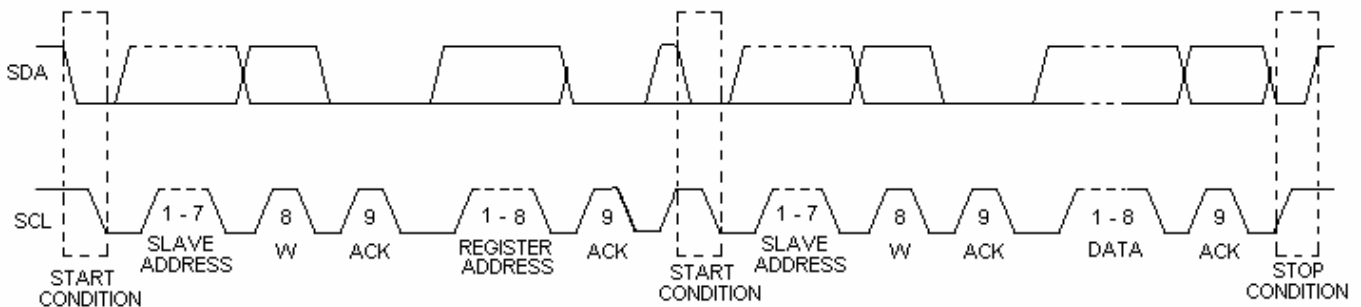

## WRITE INSTRUCTION SEQUENCE

Standard protocol:



### Write Instruction Example - Setting 20mA Current in LEDB1 and LEDB2

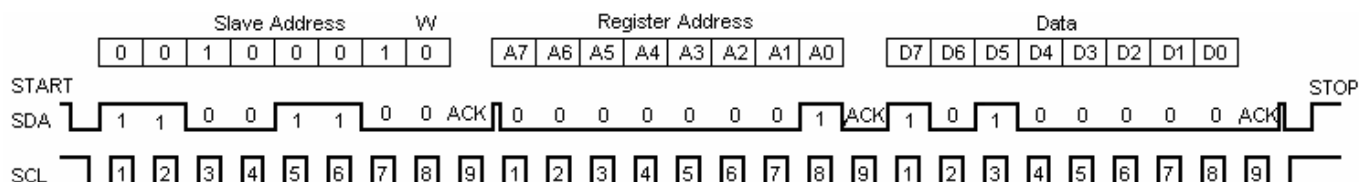

## REGISTER CONFIGURATION AND PROGRAMMING

ADDRESS	DESCRIPTION	BITS	NOTES
00h	Bank A Current setting	8	Reg00h – Reg02h data code = ( $I_{LED} / 0.125 \text{ mA}$ ) (decimal) converted into hex format
01h	Bank B Current setting	8	
02h	Bank C Current setting	8	
03h	Channel Enable	6	Bits 5:0 = 1 enables LEDs C2, C1, B2, B1, A2, A1 respectively (See Table 1). Both LEDs from one bank should be disabled to minimize power consumption.
04h	Global PWM Dimming	8	Log mode: (default) Simultaneously decreases $I_{LED}$ in banks A – C by $\sim -0.17 \text{ dB}$ per step (256 steps). Data Code 00h = 0 dB dimming, FEh = $-72 \text{ dB}$ FFh = OFF Example: 50% brightness reduction ( $-6 \text{ dB}$ ) requires: $-6 \text{ dB} / -0.17 \text{ dB} = 35$ (decimal) = 23h steps Linear Mode: Simultaneously decreases $I_{LED}$ in banks A – C by subtracting Global Dimming Code (Reg04h data) from PWM Duty Cycle Code (Reg05h – Reg07h data) Data Code 00h = 0 dimming, If Global Dimming Code is equal or exceeds PWM Duty Cycle Code, $I_{LED} = 0 \text{ mA}$ .
05h	Bank A PWM Duty Cycle	8	Log Mode: (default): $\sim -0.17 \text{ dB}$ dimming per LSB for $< 98\%$ Dimming Level (i.e. $> 2\%$ Duty Cycle) from full scale; Refer to 8 to 12 bit conversion curve (Figure 3 and Table A4.1) for resolution in range 100% to 98% Dimming Level (i.e. 0% to 2% Duty Cycle). Data Code 00h = 0% Duty Cycle or 100% Dimming Level, FFh = 100% Duty Cycle or 0% Dimming Level Example: 50% brightness reduction ( $-6 \text{ dB}$ ) requires: $255 - (-6 \text{ dB} / -0.17 \text{ dB}) = 255 - 35 = 220$ (decimal) = DCh steps Linear Mode: PWM Duty Cycle resolution $\sim 0.39\%$ per LSB Code 00h = 0% Duty Cycle, FFh = 100% Duty Cycle
06h	Bank B PWM Duty Cycle	8	
07h	Bank C PWM Duty Cycle	8	

ADDRESS	DESCRIPTION	BITS	NOTES
19h	Digital Test Mode	8	See Table 2; Bit 5 = 1 sets user-initiated LED short/open diagnostic
1Ch	LED shorted to GND	6	Bits from bit 5 to bit 0 represent LED status for LEDC2 – LEDA1 respectively. Bit = 1 represents LED shorted to GND. When the corresponding bit in the “faults” detection register, 1Dh, is also High=1, and the associated LED driver current is disabled.
1Dh	LED Fault Detected (LED shorted to $V_{IN}$ or open)	6	Bits from bit 5 to bit 0 represent LED status for LEDC2 – LEDA1 respectively. Bit = 1 represents that an LED Fault is detected. If the corresponding bit in register 1Ch is also High =1, then the LED is shorted to ground and current driver is disabled. If the corresponding bit in register 1Ch is Low=0 then the LED is either shorted to $V_{IN}$ or open
1Eh	Configuration register	8	See Table 3
1Fh	Software reset, Standby	8	See Table 4
49h	Ta-Tj Temperature Offset	8	Two 4-bit compensation offsets between Ta and Tj; Bit [7:4] = temperature offsets for LED temperature Bit [3:0] = temperature offset for Silicon diode temperature Each LSB = 5°C; temperature adjustment range from -40°C to +35°C Code 1000 in either nibble = -40°C offset; Code 0111 in either nibble = +35°C offset. See Tables 5 and 6
4Ah	LED shutdown Temperature	5	Defines T-code, at which LED current shuts down per LED vendor de-rating specification (see Table 7); Factory default value = 11100 (bin) = 1Ch represents 105°C.
4Bh	2-x Table enable and breakpoint (T-code)	6	Bit 5 = 1 – enable 2-x scale LUT $\Delta$ PWM code correction (de-rating) starting at the breakpoint set by T-code (bits 4:0) Bit 5 = 0 – 1-x scale (default) for entire temperature range Bit [4:0] defines T-code, where temperature derating starts, or where 2-x scaling begins (see Table 7) 1-x scale is ~ ± 0.17dB per step 2-x scale is ~ ± 0.34dB per step
50h – 5Fh	LUT-B $\Delta$ PWM code1[7:4], $\Delta$ PWM code0[3:0] – $\Delta$ PWM code31[7:4], $\Delta$ PWM code30[3:0]	8	Two LUT words per 1°C address. Each word contains two 4-bit numbers representing of $\Delta$ PWM codes. See Table 8 and Appendix 1 for LUT programming. Coding is different for Logarithmic and Linear Modes.
60h – 6Fh	LUT-G $\Delta$ PWM code1[7:4], $\Delta$ PWM code0[3:0] – $\Delta$ PWM code31[7:4], $\Delta$ PWM code30[3:0]	8	See above:
70h – 7Fh	LUT-R $\Delta$ PWM code1[7:4], $\Delta$ PWM code0[3:0] – $\Delta$ PWM code31[7:4], $\Delta$ PWM code30[3:0]	8	See above:
A0h	Silicon diode $dV_F/dT$ [7:0]	8	Silicon diode $V_F$ temperature coefficient : Factory recommended value = -1.71 mV/°C = 001 10110 (bin) = 36h, where bits from bit 7 to bit 5 represent integer part [1(decimal) = 001 (bin)], and bits from bit 4 to bit 0 – fractional part [0.710 / 0.03125 = 22 (decimal) = 10110 (bin)]

ADDRESS	DESCRIPTION	BITS	NOTES
A2h	LED-A $dV_F/dT$ [7:0]	8	User-loaded $V_F$ temperature coefficient for LEDs used at Banks A, B, C respectively. Negative tracking assumed with temperature; Bits from bit 7 to bit 5 represent integer part and bits from bit 4 to bit 0 - fractional part of the coefficient Example: Temperature coefficient = $-2.26 \text{ mV}^\circ\text{C}$ ; Bit 7 – bit 5 = 2 (decimal) = 010 (bin), and Bit 4 – bit 0 = $\text{INT}\{0.26 / 0.03125\} = 8$ (decimal) = 01000 (bin) User loads 010 01000 (bin) = 48h = $-2.25$ (closest setting)
A4h	LED-B $dV_F/dT$ [7:0]	8	
A6h	LED-C $dV_F/dT$ [7:0]	8	
C0h	Silicon diode $\eta$ [7:0]	8	Silicon diode $\eta$ (eta) or non-ideality factor: Factory recommended loaded value = 1.0000 = 01000000(bin) = 40h Bits from bit 7 to bit 6 represent integer part and bits from bit 5 to bit 0 - fractional part (resolution = 0.015625 per LSB) Example: $\eta = 1.000$ ; Bit 7 – bit 6 = 1 (decimal) = 01 (bin), and Bit 5 – bit 0 = $\text{INT}\{0.000 / 0.015625\} = 0$ (dec) = 000000 (bin) User loads 01 000000 = 40h = 1.0000
D0h	LED $T_j$ offset [4:0]	5	LED $T_j$ offset from $T_a$ (user-loaded) – correction from ambient temperature to LED junction temperature. Factory default = 04h Accounts for LED package thermal characteristics. See Appendix 3 for details.
D2h	Silicon diode $T_a$ offset [4:0]	5	Silicon diode $T_j$ offset from $T_a$ – correction from ambient temperature to Silicon diode junction temperature. Accounts for LDS8160 package thermal characteristics. Factory default = 02h
D4h	Silicon diode $R_s$ offset [7:0]	8	Silicon diode series resistance offset Factory recommended loaded value = 04h (4 decimal) = $\sim 68 \Omega = R_{s-si}$ Formula (decimal) = $8192 \times [(R_{s-si} \times 8 \times 10^{-6} \text{ A}) / 1.14 \text{ V}]$
D6h	LED-A $R_s$ offset [7:0]	8	$R_s$ offset (user-loaded) for Banks A, B, and C LEDs for specific LEDs used. User loads per LED used. (1/slope of high current region of LED I-V characteristic). Formula (decimal) = $8192 \times [(R_s \Omega \times 8 \times 10^{-4} \text{ A}) / 1.14 \text{ V}] \text{ LEDs}$
D8h	LED-B $R_s$ offset [7:0]	8	
DAh	LED-C $R_s$ offset [7:0]	8	
DCh	$T_{\text{MIN}}$ offset [7:0]	8	Offset to establish minimum T-code = 0 This offset insures that $-35\text{C}^0$ will equal T-code = 0. Factory default supplied (237 decimal = EDh)

**Table 1**

Register Address	Channel Enable Register							
	Bit 7	Bit 6	Bit 5	Bit 4	Bit 3	Bit 2	Bit 1	Bit 0
03h	LED OT Flag 1 = OT	N/A	Enable C2	Enable C1	Enable B2	Enable B1	Enable A2	Enable A1



**Table 2**

Register Address	Digital Test Modes Register							
	Bit 7	Bit 6	Bit 5	Bit 4	Bit 3	Bit 2	Bit 1	Bit 0
19h	Factory Only		Diagnostics Request	PWM Ramp Bypass = 1	PWM Fast Ramp = 1	Factory Only	Post ADC Filter On = 1	Factory Only
	0*	0*	0*	0*	PWM Slow Ramp = 0*	0*	Filter Bypass=0*	0*

**Note:** \*) Value by default

**Table 3**

Register Address	Configuration Register							
	Bit 7	Bit 6	Bit 5	Bit 4	Bit 3	Bit 2	Bit 1	Bit 0
1Eh	RGB mode with 3 LUTs (3 PWM) = 1*	PWMs in Linear mode = 1	Factory Only (Leave set to 0)	Silicon Diode enable = 1	PWM starts simultaneously = 1	dT adjust disable = 1*	Soft Start PWM Ramp disabled = 1	LP standby mode = 1
	WLED mode with 1 LUT (1 PWM) = 0	PWMs in Logarithmic mode = 0*	0*	Silicon Diode disable = 0*	PWMs shifted by 120° = 0*	dt_adjust enabled = 0	Soft Ramp enabled = 0*	Normal standby mode = 0*

**Note:** \*) Value by default

**Table 4**

Register Address	Control Register							
	Bit 7	Bit 6	Bit 5	Bit 4	Bit 3	Bit 2	Bit 1	Bit 0
1Fh	Software reset = 1	Standby mode = 1	Temperature request = 1	Calibration request = 1	Custom OSC trim = 1	Osc trim 2 **	Osc trim 1 **	Osc trim 0 **
	Normal operation = 0*	Normal operation = 0*	Normal operation = 0*	Normal operation = 0*	Factory preset value = 0*			

**Note:** \*) Value by default

\*\*\*) Trim code defined by customer

Bit 7 = 1 — Software reset: resets device, all registers reset/cleared.

Bit 6 = 1 — Standby (oscillator disabled, all registers retain programmed values.)

**Table 5: Ta-Tj Temperature Gradient Offset**

( set offset code to match reference De-rate point in LUT from LED Tj to Ta. Typically LED and Si are equal)

Register Address	Control Register							
	Bit 7	Bit 6	Bit 5	Bit 4	Bit 3	Bit 2	Bit 1	Bit 0
49h	LED Offset 3	LED Offset 2	LED Offset 1	LED Offset 0	Si Diode Offset 3	Si Diode Offset 2	Si Diode Offset 1	Si Diode Offset 0
	0*	0*	0*	0*	0*	0*	0*	0*

**Note:** \*) Value by default

**Table 6: Offset Codes for Tj-Ta Temperature Gradient Offset (both LED and Si per Table 5).**

Temperature Offset °C (Ta-Tj)	Bit3 – Bit 0	Temperature Offset °C (Ta-Tj)	Bit3 – Bit 0	Temperature Offset °C (Ta-Tj)	Bit3 – Bit 0	Temperature Offset °C (Ta-Tj)	Bit3 – Bit 0
-40	1000	-20	1100	0	0000	20	0100
-35	1001	-15	1101	5	0001	25	0101
-30	1010	-10	1110	10	0010	30	0110
-25	1011	-5	1111	15	0011	35	0111

**Table 7: T-code values vs. Temperature (for registers 4Ah and 4Bh)**

Temperature, °C	Bit4 – Bit 0	Temperature, °C	Bit4 – Bit 0	Temperature, °C	Bit4 – Bit 0	Temperature, °C	Bit4 – Bit 0
-35	00000	5	01000	45	10000	85	11000
-30	00001	10	01001	50	10001	90	11001
-25	00010	15	01010	55	10010	95	11010
-20	00011	20	01011	60	10011	100	11011
-15	00101	25	01100	65	10100	105	11100
-10	00101	30	01101	70	10101	110	11101
-5	00110	35	01110	75	10110	115	11110
0	00111	40	01111	80	10111	120	11111

**Table 8: ΔPWM Code Allocation**

Register Address	Data bits		Register Address	Data bits	
	7 – 4	3 – 0		7 – 4	3 – 0
	ΔPWM code for temperature, °C			ΔPWM code for temperature, °C	
50h, 60h, 70h	-30	-35	58h, 68h, 78h	50	45
51h, 61h, 71h	-20	-25	59h, 69h, 79h	60	55
52h, 62h, 72h	-10	-15	5Ah, 6Ah, 7Ah	70	65
53h, 63h, 73h	0	-5	5Bh, 6Bh, 7Bh	80	75
54h, 64h, 74h	10	5	5Ch, 6Ch, 7Ch	90	85
55h, 65h, 75h	20	15	5Dh, 6Dh, 7Dh	100	95
56h, 66h, 76h	30	25	5Eh, 6Eh, 7Eh	110	105
57h, 67h, 77h	40	35	5Fh, 6Fh, 7Fh	120	115

**Table 9: ΔPWM Codes vs. Number of Adjustment Steps**

Number of steps	Binary Code	Number of steps	Binary Code	Number of steps	Binary Code	Number of steps	Binary Code
Not Valid	1000	-4	1100	0	0000	4	0100
-7	1001	-3	1101	1	0001	5	0101
-6	1010	-2	1110	2	0010	6	0110
-5	1011	-1	1111	3	0011	7	0111

## PROGRAMMING EXAMPLES

Operation	Register Address	Register Data	Command (hex)
Set 18 mA current at Bank LEDA	00h	90h	XX 00 90
Set 20 mA current at LEDA, 18 mA at LEDB, and 15 mA at LEDC banks (assuming address at 00h and consecutive writes)	00h	A0h 90h 78h	XX A0 90 78
Turn LEDs A1, B1 and C1 on, all others off	03h	15h	XX 03 15
Turn LEDs A2, B2, and C2 on, all others off	03h	24h	XX 03 24
Turn all LEDs on	03h	3Fh	XX 03 3F
Decrease brightness at 50% (-6 dB) at all three channels simultaneously (in logarithmic mode only)	04h	23h	XX 04 23
Decrease brightness at 75% (-12 dB) at all three channels simultaneously (in logarithmic mode only)	04h	47h	XX 04 47
Restore full brightness at all three channels simultaneously	04h	00h	XX 04 00
Set Bank B PWM duty Cycle at 50% (-6 dB) in logarithmic mode	06h	DCh	XX 06 DC
Set Bank B PWM duty Cycle at 50% in linear mode	06h	80h	XX 06 80
Short/open LED diagnostic request	19h	20h	XX 19 20
Read out LED short to GND status	1Ch		XX 1C YY
Read out LED short to $V_{IN}$ /open status	1Dh		XX 1D YY
Set WLED Mode with 1 PWM generator in linear mode, soft start disabled, and LP standby mode	1Eh	43h	XX 1E 43
Set Standby Mode	1Fh	40h	XX 1F 40
Resume normal operation from standby mode	1Fh	00h	XX 1F 00
Calibration request (conduct temperature calibration; wait $\geq 16$ ms)	1Fh	10h	XX 1F 10
Set LEDs in shutdown mode at temperature above 85°C	4Ah	18h	XX 4A 18
Set 2-x scale de-rating at temperature equal or above 55°C	4Bh	32h	XX 4B 32
Software Reset (to default values) and/or clear of all registers	1Fh	80h	XX 1F 80

**Note:** XX – The LDS8160 I<sup>2</sup>C customer-selected slave address followed by binary 0 for write command, i.e. if I<sup>2</sup>C slave address is 001 0001 (see Table 10), XX = 0010 0010 (bin) = 22h  
 YY – The LDS8160 I<sup>2</sup>C customer-selected slave address followed by binary 1 for read command, i.e. if I<sup>2</sup>C slave address is 001 0001 (see Table 10), YY = 0010 0011 (bin) = 23h

## PIN DESCRIPTION

Pin #	Name	Function
1	SCLK	I <sup>2</sup> C Serial clock input
2	SDAT	I <sup>2</sup> C Serial data input/output
3	SADD	I <sup>2</sup> C Serial interface Addresses Programming
4	GND	Ground Reference
6	EN	Device enable (active high)
8	LEDC2	LEDC2 anode terminal
9	LEDC1	LEDC1 anode terminal
10	LEDB2	LEDB2 anode terminal
11	LEDB1	LEDB1 anode terminal
12	LEDA2	LEDA2 anode terminal
13	LEDA1	LEDA1 anode terminal
14	V <sub>IN</sub>	Power Source Input; connect to battery or supply
15	TST	Test pin
5, 7, 16	NC	Not connect (no internal connect to the device)
PAD	PAD	Connect to GND on the PCB

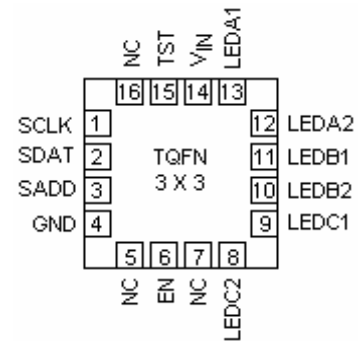

Top view: TQFN 16-lead 3 X 3 mm

## PIN FUNCTION

**V<sub>IN</sub>** is the supply pin. A small 1 $\mu$ F ceramic bypass capacitor is required between the V<sub>IN</sub> pin and ground near the device. The operating input voltage range is from 2.3 V to 5.5 V.

**EN** is the enable input for the device. Guaranteed levels of logic high and logic low are set at 1.3 V and 0.4V respectively. When EN is initially taken high, the device becomes enabled and can communicate through I<sup>2</sup>C interface after a 500  $\mu$ sec wakeup (initialization) period.

**SDAT** is the I<sup>2</sup>C serial data line. This is a bidirectional line allowing data to be written into and read from the registers of the LDS8160

**SCLK** is the I<sup>2</sup>C serial clock input.

**SADD** is I<sup>2</sup>C Serial interface Addresses Programming pin that allows choice of one of four I<sup>2</sup>C addresses preprogrammed in device.

**GND** is the ground reference for internal circuitry. The pin must be connected to the ground plane on the PCB.

**LEDA1 – LEDC2** provide the internal regulated current sources for each of the LED anodes. These pins enter high-impedance zero current state whenever the device is in shutdown mode.

**PAD** is the exposed pad underneath the package. For best thermal performance, the tab should be soldered to the PCB and connected to the ground plane

**TST** is a test pin used by factory only. Leave it floating (no external connection)

## BLOCK DIAGRAM

Figure 2: LDS8160 Functional Block Diagram

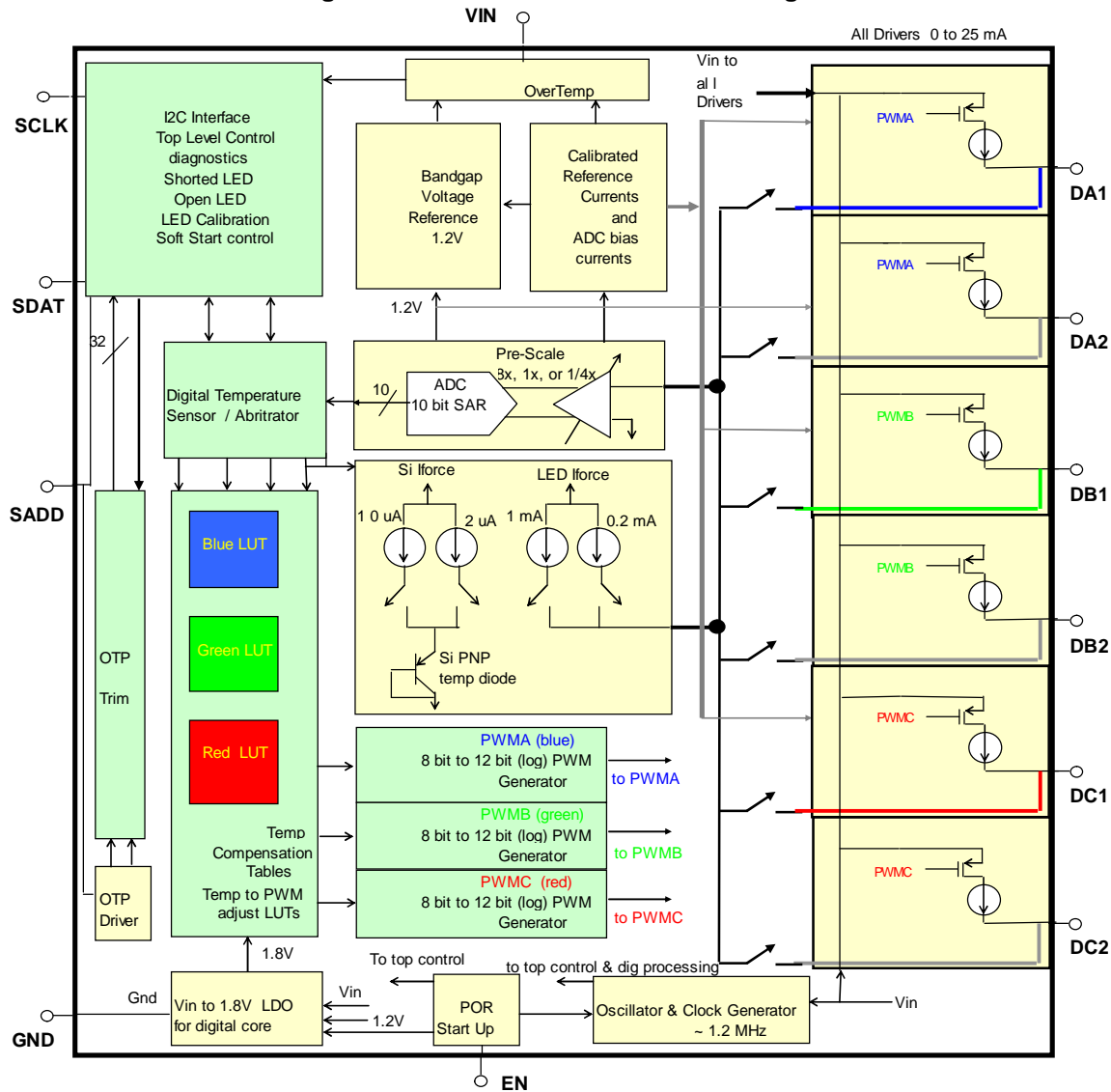

## BASIC OPERATION

The LDS8160 may operate in follow modes:

- Normal Operation Mode
- Custom Operation Modes
- Normal Standby Mode
- Low Power (LP) Standby Mode
- Programming Modes
- Shutdown Mode

### NORMAL OPERATION MODE

At power-up,  $V_{IN}$  should be in the range from 2.3 V to 5.5 V (max). If  $V_{IN}$  is slow rising, EN pin should be logic LOW at least until  $V_{IN}$  reaches 2.3 V level.

When EN is taken HIGH, a soft-start power-up sequence begins and performs internal circuits reset that requires less than 100  $\mu$ s.

An initialization sequence then begins taking less than 10 ms. This sequence determines the user-selected I<sup>2</sup>C slave address, loads factory programmed settings, and conducts initial diagnostics for open/shorted LEDs.

At this point, the I<sup>2</sup>C interface is ready for communication and the LDS8160 may be user-programmed. Upon programming completion for all required initial parameters and features' settings, a calibration command is given by setting bit 4 of the

Control Register (1Fh) HIGH. This starts the calibration sequence of the LDS8160 LED-Sense™ temperature compensation circuits. The calibration process takes approximately 16 ms.

The user can then additionally program the DC current and PWM duty cycles for the LEDs. A PWM ramp-up sequence occurs after the writing to the PWM registers. This ramp-up delay is less than 250 ms in the default soft-start ramp mode, or can be 64 ms using the optional fast (4x) ramp mode (bit 3 of Register 19h = HIGH). A further option is available to bypass the soft-start PWM ramp mode entirely and the initialization time will be reduced to just the calibration sequence time of ~ 16ms. The initial soft-start ramp mode can be bypassed by setting bit 4 of register 19h HIGH.

The calibration parameters for the temperature measurement engine and all customer-set parameters remain intact until the part is reset or powered-down. Additionally, the user can re-calibrate LDS8160 during times when LED currents are brought to zero and the system is thermally stabilized by programming the calibration command bit as discussed.

Factory preset values (upon completion of the power-up initialization but prior to user programming) are as follow (see Table3):

- a) All LEDs are disabled and  $I_{LEDA, B, C} = 0$ ;
- b) RGB mode with three independent Luminosity vs. Temperature correction tables (LUTs) selected and three PWM generators;
- c) PWM dimming control in Logarithmic Mode with PWM generators running by  $120^\circ$  phase shift;
- d) LED temperature compensation enabled with LUTs in Logarithmic Mode Soft start/shutdown enabled;
- e) Internal Diode for temperature compensation is enabled
- f) LEDs are used as sensors for temperature compensation control.

## LED Current Setting

Current setting registers 00h – 02h should be programmed using I<sup>2</sup>C interface and desired LEDs should be enabled using register 03h before LEDs turn on.

The standard I<sup>2</sup>C interface procedure is used to program  $I_{LED}$  current (see section “I<sup>2</sup>C INTERFACE”). LDS8160 should be addressed with slave address chosen followed by register address (00h, 01h, or

02h) and data that represents the code for the desired LED current. (See Table 10 for accessible slave addresses.)

Code for LED current is determined as  $I_{LED}/0.125$  mA in hex format, i.e. 20 mA current code =  $20/0.125 = 160$  (dec) = A0h.

The LDS8160 maximum current should not exceed 25 mA per LED (i.e. current code should not exceed 200 (dec) = C8h) to meet all electrical specifications.

To turn LEDs ON/OFF register 03h should be addressed with data that represents the desired combination of LEDs turned ON/OFF (see Table 1); i.e. if LEDC1, LEDC2, LEDA1, LEDA2 should be ON, and LEDB1, LEDB2 should be OFF, binary code that should be written into register 03h is 110011 (bin) = 33h.

The LDS8160 allows two ways for LED current setting. One of them is using registers 00h – 02h (static mode) and other one by using the PWM signal to decrease average LED current value set by these registers (dynamic mode).

For dynamic mode, the LDS8160 integrates 3 digital PWM generators that operate at a frequency of ~ 285 Hz. In Logarithmic Mode, the PWM generators are 12-bit resolution and can be programmed with an 8-bit code to provide 256 internally mapped 12-bit logarithmic duty cycle steps to adjust the dimming level. In Linear Mode, the PWM generates 256 linear duty cycle steps to adjust the dimming levels from the user programmed 8-bit code.

The advantage of PWM dimming is stable LED color temperature / wavelength that are determined by the maximum LED current value set by registers 00h – 02h.

To use the dynamic PWM mode for LED current setting, the maximum  $I_{LED}$  value should be first set by registers 00h – 02h as described above in static mode and the desired PWM dimming should be set by registers 05h – 07h. In Logarithmic Mode, set by default, dimming resolution is approximately -0.17 dB per step with 0dB dimming, or 100% duty cycle, at the 256<sup>th</sup> step.

## Global PWM Dimming

The LDS8160 allows Global PWM Dimming control of all three banks in the RGB Logarithmic mode, set by default. It is convenient, because it allows the user to simultaneously change LED brightness equally across to all three channels independent of the maximum static current setting (registers 00h, 01h and 02h) in a particular channel.

For example, to decrease LED brightness by 50% (-6dB) at all three LED banks, Global PWM Dimming data code written in register 04h should be  $6/0.17 = 35$  (decimal) = 23h (see Figure 6: Global Dimming in Logarithmic Mode in percent vs. register 04h data (0% dimming = full LED brightness)).

The LDS8160 integrates temperature measurement and compensation processing to maintain stable LED brightness across varying ambient temperature and de-rate power dissipated by LEDs, if the LED die temperature exceeds a preset value.

**Figure 3: Dynamic Mode Dimming in Logarithmic Mode in dB vs. registers 05h – 07h data (0dB dimming = full LED brightness)**

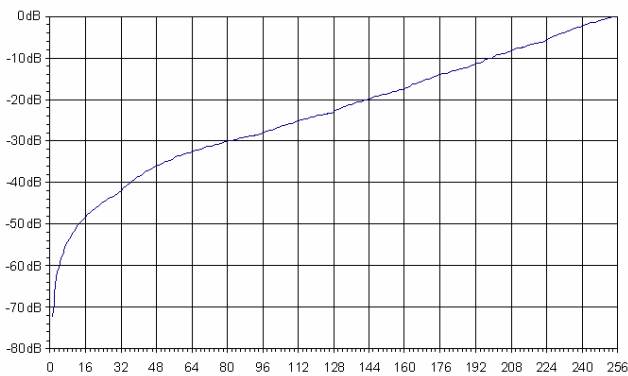

**Figure 4: Dynamic Mode Dimming in Logarithmic Mode in percent vs. registers 05h – 07h data (0% dimming = full LED brightness)**

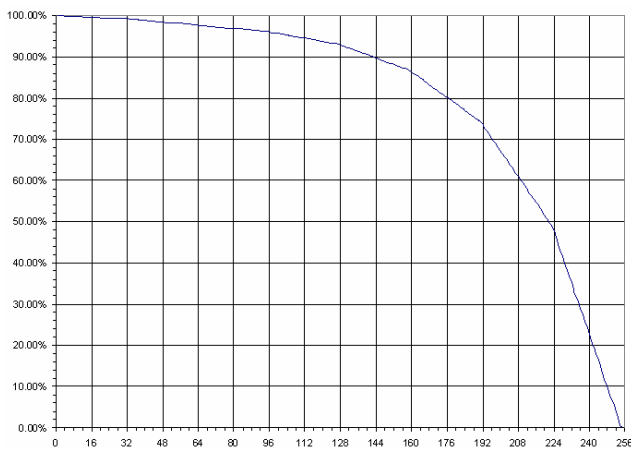

Measured temperatures are encoded into 5-bit T-codes representing 5°C temperature intervals from -35 to +120°C. The measured T-code addresses the stored ΔPWM adjustment codes to adjust the dimming level and therefore average current through the LEDs. The user loads specific ΔPWM codes into the LUTs to maintain constant average current and therefore luminosity over temperature.

LUT corrections codes are added/subtracted to/from the user-set duty cycle/dimming codes (dynamic and/or global) for the channel to correct LED brightness.

The LDS8160 integrates a 10-bit ADC and digital processing to determine LED temperatures approximately every 2.5 seconds. The proprietary LED-Sense™ algorithm allows direct measurement of LED junction temperatures on the LEDA1, LEDB1, and LEDC1 driver channels. Additionally an on-chip silicon temperature sensing diode is also measured to enhance temperature estimation accuracy.

**Figure 5: Global Dimming in Logarithmic Mode in dB vs. register 04h data (0dB dimming = full LED brightness)**

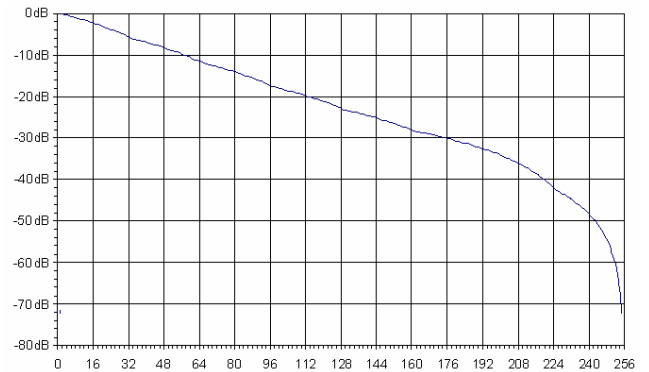

**Figure 6: Global Dimming in Logarithmic Mode in percent vs. register 04h data (0% dimming = full LED brightness)**

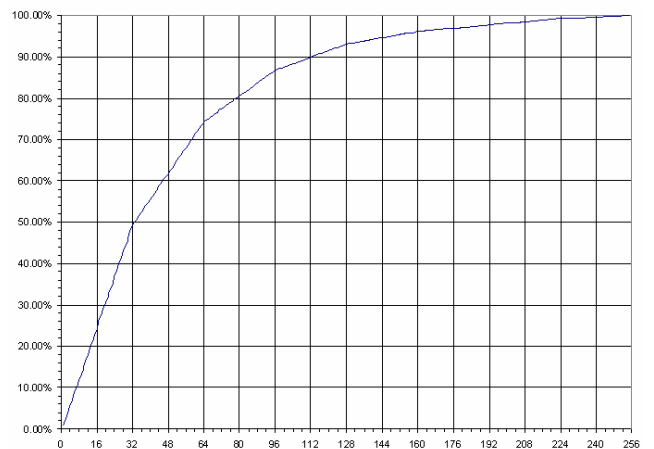

In normal operation mode, the LDS8160 senses the LED temperatures from all 3 available channels when in the default RGB (3 channel) mode, or only from the LEDA1 channel when used in the WLED (single channel) mode.

## Temperature vs. PWM Duty Cycle Profiles

The user must load the PWM correction look up tables (LUTs) prior to operation. For the LDS8160 all three tables, LUT-B, LUT-G and LUT-R require loading (even if using same data for a WLED application) with the user correction profiles prior to operation. For RGB applications, LUT-B which drives LEDA1 And LEDA2 respectively should be assigned as the Blue color channel. LUT-G which drives LEDB1 and LEDB2 should be assigned as the Green color channel, and LUT-R which drives LEDC1 and LEDC2 should be the RED channel.

The correction tables are based upon LED vendor characteristics for luminosity vs temperature and current, LED current de-rating specifications, and user system thermal design parameters. Figure 7 shows an actual Luminosity vs. Temperature curve of the NSSM038AT-E RGB LED available from Nichia Corp.

**Figure 7: Luminosity vs. Temperature curve (NSSM038AT-E RGB LED from Nichia)**

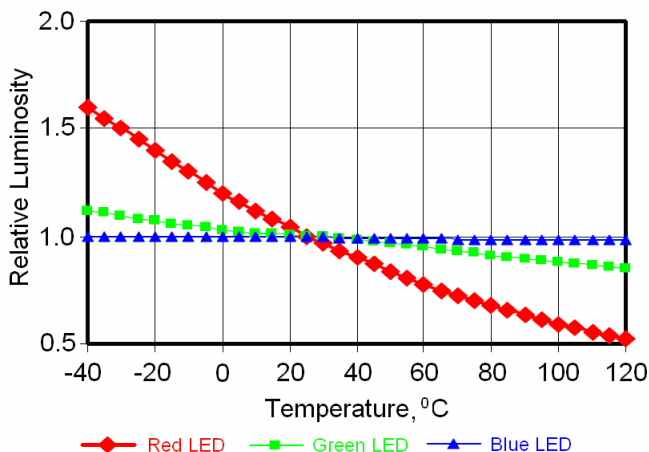

Figure 8 shows the typical LED characteristic of decreasing illumination over temperature, but each color changes differently. This results in white light color shifts over temperature if not accounted for. It is typical to see RED LED Luminosity vs Temperature to change by  $\pm 50\%$  relative to the 25°C level.

Figure 9 shows that luminosity is linearly dependent with LED forward currents  $\leq 30$  mA. Therefore loss of LED luminosity over temperature can be compensated for by associated increases in LED current.

Figure 9 gives the total RGB Power de-rating specification for the same Nichia NSSM038AT-E RGB LED. Total power is the combined power ( $V_F \times I_F$ ) of each color LED. This curve specifies the maximum RGB LED power that insures not exceeding the maximum specified junction

temperature with maximum ambient operating temperature of 85°C.

**Figure 8: Luminosity vs. LED Forward Current for Nichia NSSM038AT-E RGB LED**

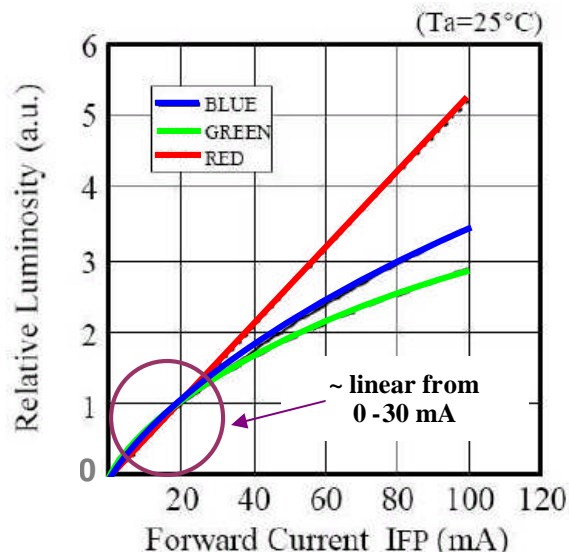

**Figure 9: Total power (combined R, G, and B diodes) power de-rating curve (NSSM038AT-E RGB LED from Nichia)**

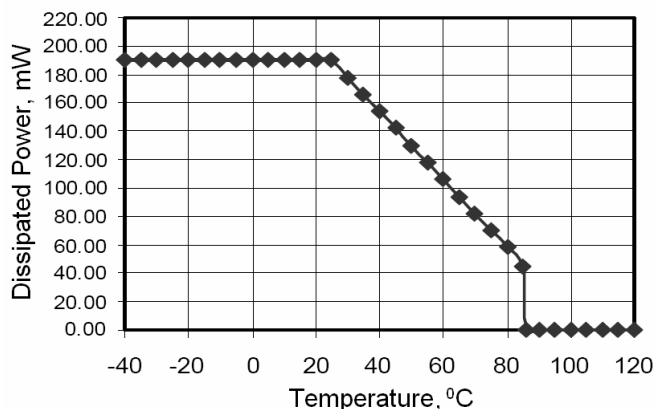
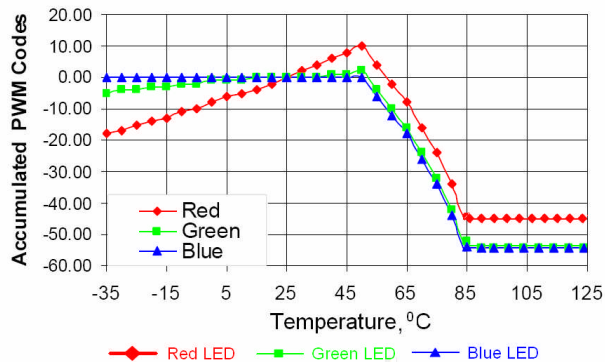

Figure 10 shows the final plot of typical LDS8160 PWM LUT correction profiles that could be programmed by the user to adjust for this RGB LED. This accumulated correction takes into account both the Luminosity vs Temperature variations and the adjustments to meet the higher temperature power de-rating specification.

Given the 5°C increments of the temperature adjustment intervals for the LDS8160, the currents are slowly ramped to equalize loss of light output before the de-rating profile begins. Once de-rating begins, the PWM duty cycle is reduced, lowering LED driver current, to insure meeting and regulating to the desired maximum operating temperature.



**Figure 10: Example LDS8160 Accumulated PWM Correction Curves for Nichia NSMM038AT-E RGB LED for ILED nominal (R, G, & B) = 15 mA @ 25°C**



Appendix 1 describes how to generate PWM LUT correction profiles. Additionally software tools and support is available from the factory to assist customers to generate LUT tables for specific LEDs and applications. Please consult the factory or a sales representative.

### Global Dimming Limitations

The final PWM dimming code value is the algebraic sum of three codes: Dynamic Dimming code, Global Dimming Code, and the Temperature Compensation Code. If this sum is equal to or below zero, the LED in that particular channel is disabled. It means that the Global Dimming dynamic range is limited by Dynamic Dimming and the Temperature Correction Table used.

As an example:

If the user set PWM Dynamic Dimming in a particular channel is set to -20 dB (registers 05h – 07h data = code 143 (dec)) and the LED-Sense™ Temperature vs. PWM Correction requires 7 steps correction dimming (data code 7 (dec)), the resultant allowable additional Global Dimming range = 143 – 7 = 136 (dec) steps or ~ - 23.1 dB.

### I<sup>2</sup>C Interface

The LDS8160 uses a 2-wire serial I<sup>2</sup>C-bus interface. The SDAT and SCLK lines comply with the I<sup>2</sup>C electrical specification and should be terminated with pull-up resistors to the logic voltage supply. When the bus is not used, both lines are high. The device supports a maximum bus speed of 400kbit/s. The serial bit sequence is shown at REGISTER CONFIGURATION AND PROGRAMMING section for read and write operations into the registers. Read and write instructions are initiated by the master controller/CPU and acknowledged by the slave LED driver.

The LDS8160 allows user to choose between one of four preprogrammed I<sup>2</sup>C addresses by connecting SADD pin (#3) either to ground, SCLK, SDAT or V<sub>IN</sub> pin (see Table 10). Consult factory about other addresses available.

**Table 10: LDS8160 I<sup>2</sup>C Slave Addresses**

SADD pin connected to	I <sup>2</sup> C Address	
	Binary code	Hex
Ground	001 0001	11h
SCLK	001 0101	15h
SDAT	101 0001	51h
V <sub>IN</sub>	101 0101	55h

For further details on the I<sup>2</sup>C protocol, please refer to the I<sup>2</sup>C-Bus Specification, document number 9398-393-40011, from Philips Semiconductors.

### Recommended User Register Initialization

Table 11 is provided as a recommended user I<sup>2</sup>C register initialization and calibration sequence for the the LDS8160 for an RGB LED application. RED values in the table mean these registers are user/system dependent. Any values shown are for example only.

### Unused LED Channels

For applications with less than six white or two RGB LEDs, unused LED banks can be disabled via the I<sup>2</sup>C interface by addressing register 03h with data that represent desired combination of LEDs turned ON/OFF (see Table 1).

The LDS8160 unused LED outputs can be left open.

### LED short/open protection

The LDS8160 runs a LED short/open diagnostic routine upon the power up sequence. It detects both LED pins shorted to ground and LED pins that are open or shorted to V<sub>IN</sub> (fault conditions).

The results for short to GND detection are stored in Diagnostics Register 1Ch. Bits from bit 5 to bit 0 indicate a short status as bit = 1 for LEDC2 - LEDA1 respectively, if the corresponding bit in the LED Faults detection Diagnostics register, 1Dh, is also High=1. A short to GND is detected if the measured LED pin voltage is less than ~ 0.14 V independent of the programmed LED current. Every channel detected as shorted, is disabled

**Table 11: Recommended Register Load Sequence for LDS8160**

Registers' Load Sequence #	Register (hex)	Value (hex)	Comments
1	1Eh	8Ah	Initialize Configuration Register
2	00h	A0h	Bank A ILED DC current @ 20 mA
3	01h	A0h	Bank B ILED DC current @ 20 mA
4	02h	A0h	Bank C ILED DC current @ 20 mA
5	03h	3Fh	Assume dual RGB use – enable all drivers
6	04h	00h	Global PWM Dimming 00h is full ON = 100% DC
7	05h	E7h	Duty Cycle code for Blue channel PWM. Use set E7h=64% DC. User uses to establish desired White Balance
8	06h	FBh	Same as reg 05h, but for Green PWM. FBh=95% DC.
9	07h	FAh	Same as reg 05h, but for Red PWM. FAh=90% DC
10	49h	00h	Ta-Tj Offset
11	4Ah	1Ch	Set LED Shutdown temperature 1Ch = 105C = Tj
12	4Bh	1Fh	Set optional 2x PWM adjust step start point; 1x scale below this point
13	A0h	36h	Load Si Diode K factor for - 1.71mV/C
14	A2h	User Loads Per LED Used	User loads LED K factor @ 1mA I <sub>F</sub> for BLED
15	A4h	User Loads Per LED Used	User loads LED K factor @ 1mA I <sub>F</sub> for GLED
16	A6h	User Loads Per LED Used	User loads LED K factor @ 1mA I <sub>F</sub> for RLED.
17	C0h	40h	Load Si Diode η factor = 1.0
18	D4h	04h	Load Si Diode R <sub>s</sub> = 68 ohms
19	D6h	User Loads Per LED Used	User loads LED R <sub>s</sub> for BLED
20	D8h	User Loads Per LED Used	User loads LED R <sub>s</sub> for GLED
21	DAh	User Loads Per LED Used	User loads LED R <sub>s</sub> for RLED
22-47	50h – 5Fh	User Loads Per LED Used	LUT-B correction Table
48-64	60h – 7Fh	User Loads Per LED Used	LUT-G correction Table
65-80	70h – 7Fh	User Loads Per LED Used	LUT-R correction Table
81	1Fh	10h	User issues temp calibration command

Test results for open or short to V<sub>IN</sub> LED pins are stored in the LED Faults Diagnostics Register 1Dh, Bits from bit 5 to bit 0 represent LEDC2 - LEDA1 respectively with bit = 1 indicates a fault condition at this particular LED pin. If the corresponding bit in register 1Ch is also High = 1, than the LED is shorted to GND as prior discussed. However when the bit in 1Dh is High = 1 and the corresponding bit in 1Ch is Low = 0, than the fault is either a short to Vin or open.

An open LED pin fault causes no harm in the LDS8160 or LED as the high side driver has no current path from V<sub>IN</sub> or GND. Therefore, the fault detection status indicates only in the 1Dh diagnostic register, and no further action is required.

In the case of and LED directly shorted to V<sub>IN</sub>, the full V<sub>IN</sub> voltage will be connected to the LED and current can flow independent of the LDS8160 LED driver circuit directly to GND. The LDS8160 will detect the fault and indicate the status in Register 1Dh, however further action needs taken at the system level to shutdown V<sub>IN</sub> power to prevent possible damage to the LED. The combined series resistance of the LED (typically ~ 10Ω or more) and additional board series resistance will result in current limiting but not sufficient to prevent damage to low power LEDs.

Besides the power-up diagnostic sequence, the user can re-initiate a diagnostic command at any time by setting bit 5 of the Digital Test Modes Register, 19h, to HIGH.

The LDS8160 restores LED current to programmed value at channels with detected shorts to GND after the fault condition is removed.

### Over-Temperature Protection

If the die temperature exceeds +150°C the driver will enter shutdown mode. The LDS8160 requires restart after die temperature falls below 130°C.

### LED Selection

If the power source is a Li-ion battery, LEDs with V<sub>F</sub> = 1.9 V - 3.3 V are recommended to achieve highest efficiency performance and extended operation on a single battery charge.

### External Components

The driver requires one external 1 μF ceramic capacitors (C<sub>IN</sub>) X5R or X7R type.

### CUSTOM OPERATION MODES

The LDS8160 allows the option to choose custom operating modes overwriting content of Configuration Register 1Eh (see Table 2).

Bit 0 of this register allows switching between standard and low power standby modes (see detailed description at “STANDBY MODE” section).

Bit 1 allows bypass soft start / ramp down if fast raising/falling LED current required.

Bit 2 allows disable LED temperature compensation if desired.

Bit 3 changes PWM generators start condition.

At normal operation mode, set by default, PWM pulse rising edge of each PWM generator is shifted by 120° in respect to two others. It allows for a decrease in input current noise especially at high LED currents. However, it may be important for better color mix in RGB mode to start all three PWM pulses simultaneously. To do so, set register 1Eh bit 3 = 1.

Bits 4, 5 are for factory use only.

The LDS8160 also provides the option for using an external remote temperature-sensing device such as a 2N3904. This option is available on channel LEDA1. In this case, channel LEDA1 should be disabled via register 03h and it cannot operate as a LED current source.

A further option is available to monitor temperatures and make adjustments only from sensing the on-chip silicon diode temperature. This option is enabled by setting bit 4 = 1 in register 1Eh. In this mode, temperature correction is via LUTA only.

Bit 6 allows to change the PWM generators operation mode from linear to logarithmic.

In Linear Mode, Dynamic Dimming resolution is ~ 0.39% per LSB. Code 00h represents 100% Dimming, while code FFh = 0%

Linear Dimming Mode recommended for WLED Mode operation only because it creates non-proportional Global Dimming in RGB Mode.

In Linear Dimming Mode, Dynamic Dimming resolution is ~0.39% per LSB. Code 00h represents 100% Dimming, while Code FFh = 0% (See Figure 11).

Bit 7 allows switch between RGB and WLED modes.

In RGB Mode, set by default, the LDS8160 uses three independent PWM generators for LED current dynamic dimming and three LUTs for independent luminosity vs temperature correction. In WLED Mode, the LDS8160 uses a single PWM generator to dim all six LEDs and one LUT for luminosity vs temperature correction. It is convenient if all six WLED should have identical brightness. However, if

two or three different brightness levels are required for LED banks A, B, and C using dynamic dimming, RGB Mode is recommended even with WLED.

**Figure 11: Global Dimming in Linear Mode in percent vs. register 04h data (0% dimming = full LED brightness)**

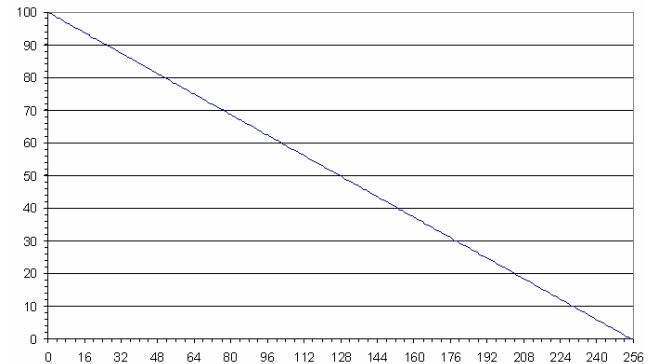

## STANDBY MODES

The LDS8160 has two standby modes, which customers may set by I<sup>2</sup>C interface addressing register 1Fh with bit 6 = 1 (see Table 4).

In both standby modes, I<sup>2</sup>C interface remains active and all registers store information.

In Normal Standby Mode the LED drivers and internal clock are off; however, some internal circuits remain active resulting in a standby current from the V<sub>IN</sub> power source of 125 μA typical. In this mode, the EN pin should be logic HIGH with signal level from 1.3 to V<sub>IN</sub> voltage.

In Low Power (LP) Standby Mode most of the device is disabled and results in very low standby current from V<sub>IN</sub> power source (5 μA typical). In LP Mode, the EN pin should be connected to a 1.8V voltage source capable to provide up to ~100 μA maximum dynamic current to LDS8160 digital core in case of any I<sup>2</sup>C interface activity.. If this voltage source is unavailable, Normal Standby Mode should be used.

To set LP Standby Mode, bit 0 in register 1Eh should be set to 1 (see Table 2) before addressing to register 1Fh.

## SHUTDOWN MODE

To set LDS8160 in shutdown mode, EN pin should be logic low more than 10 ms. The LDS8160 shutdown current is less than 1 μA. The LDS8160 wakes up from shutdown mode with factory-preset data. To preserve customer-programmed data, use either Normal or LP standby modes.

## PROGRAMMING MODES

The LDS8160 is factory preprogrammed with specific defaults for the Nichia NSSM038AT\_E RGB LEDs; however, application specific LEDs and other user system conditions may require user programming of the temperature compensation LUTs and other LED specific parameters.

After initialization and user programming the user should conduct an I<sup>2</sup>C calibration sequence command by writing Bit 4 = 1 in the Control register 1Fh. This conducts a real time calibration of the initial starting temperature and the actual LED parameters. Upon completion, Bit 4 will be internally reset to 0, and the LDS8160 is ready for use.

## TYPICAL CHARACTERISTICS

(Over recommended operating conditions unless specified otherwise)  $V_{in} = 3.6V$ ,  $C_{in} = 1 \mu F$ ,  $EN = High$ ,  $T_{AMB} = 25^{\circ}C$

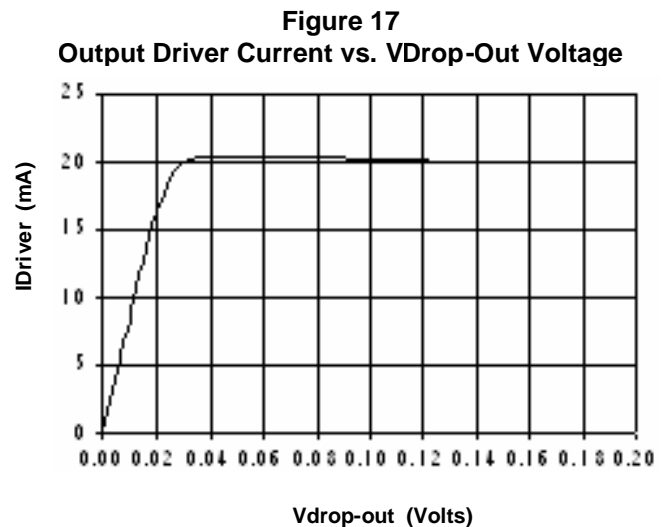
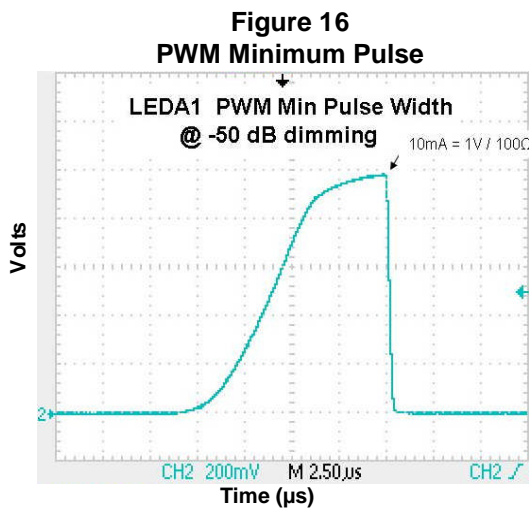
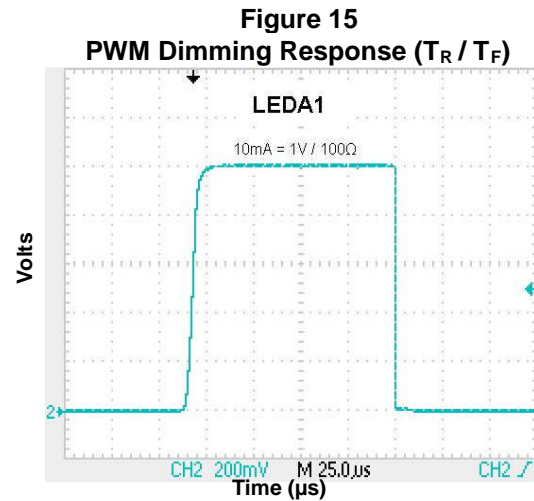
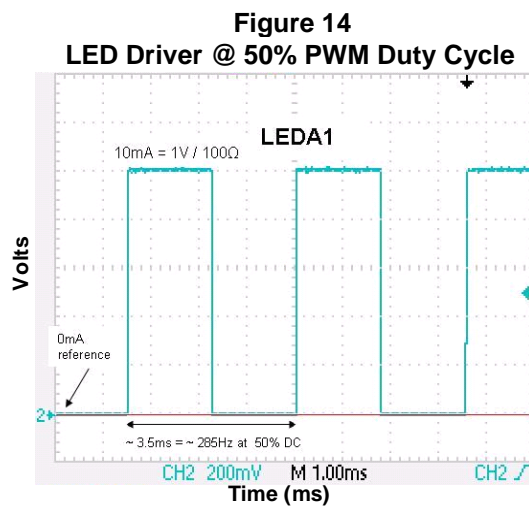
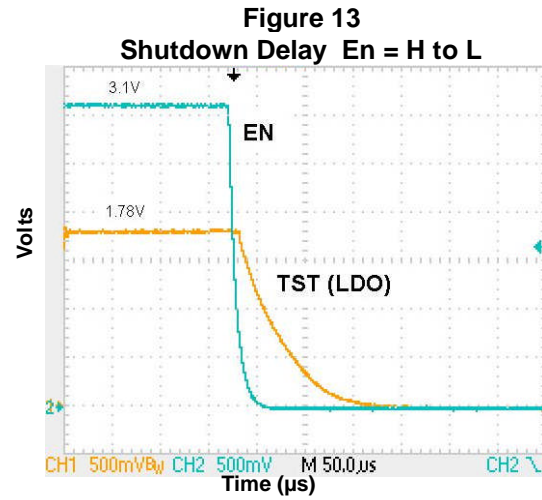
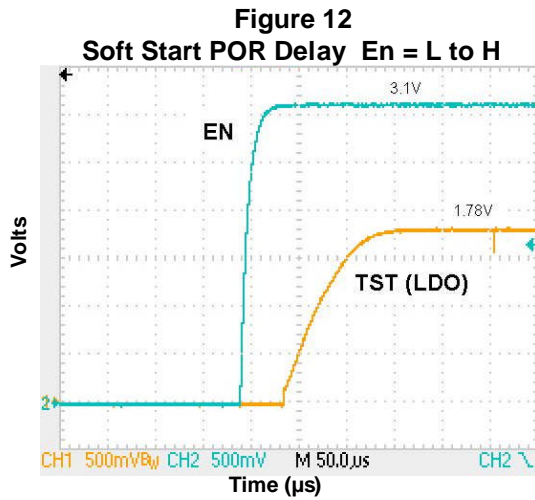

## PACKAGE DRAWING AND DIMENSIONS

16-PIN TQFN (HV3), 3mm x 3mm, 0.5mm PITCH

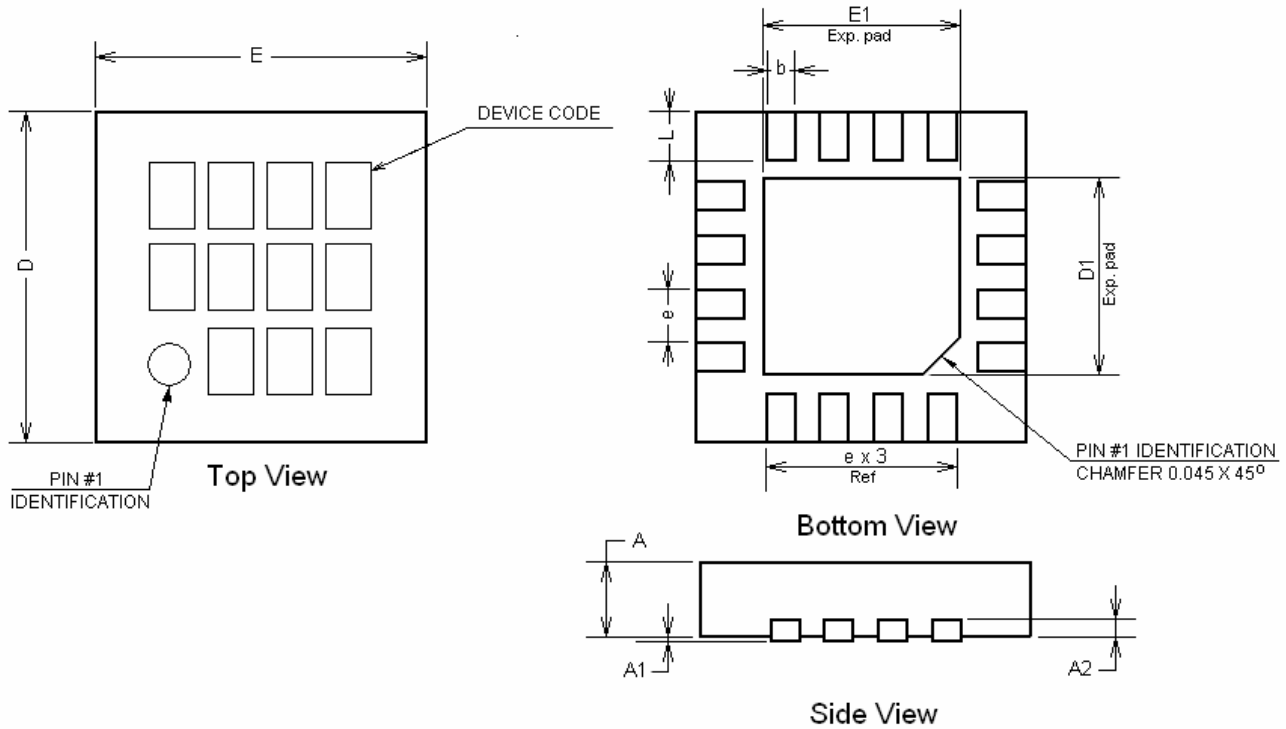

SYMBOL	MIN	NOM	MAX
A	0.70	0.75	0.80
A1	0.00	0.02	0.05
A2	0.178	0.203	0.228
b	0.20	0.25	0.30
D	2.95	3.00	3.05
D1	1.65	1.70	1.75
E	2.95	3.00	3.05
E1	1.65	1.70	1.75
e		0.50 typ	
L	0.325	0.375	0.425
m		0.150 typ	
n		0.225 typ	

Note:

1. All dimensions are in millimeters
2. Complies with JEDEC Standard MO-220

## ORDERING INFORMATION

Part Number	Package	Package Marking
LDS8160 002-T2	TQFN-16 3 x 3mm <sup>(1)</sup>	8160

**Notes:**

1. Matte-Tin Plated Finish (RoHS-compliant)
2. Quantity per reel is 2000

## EXAMPLE OF ORDERING INFORMATION

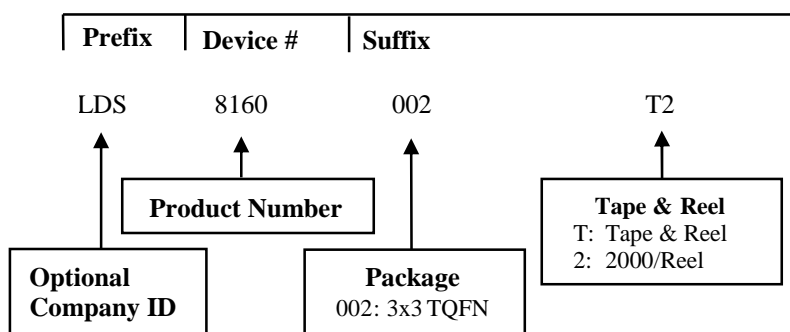

**Notes:**

- 1) All packages are RoHS-compliant (Lead-free, Halogen-free).
- 2) The standard lead finish is Matte-Tin.
- 3) The device used in the above example is a LDS8160A 002-T2 (3x3 TQFN, Tape & Reel).
- 4) For additional package and temperature options, please contact your nearest IXYS Corp. Sales office.

## Appendix 1

### CREATING LUT CORRECTION TABLES FOR LDS8160

LED luminosity (or brightness) is proportional to forward current through the device and is dependent on temperature. To maintain a constant level of luminosity, the forward current should be adjusted vs. temperature. However, changing the static forward current also shifts the chromaticity of the LED, where each white or color LED has a different dependency with temperature.

The LDS8160 uses Dynamic Dimming control to change average LED current while maintaining the peak current thereby causing no color shift. The LED-Sense™ temperature and color correction algorithm implements this current compensation feature by adjustment of the PWM duty cycles vs. the LEDs' temperature. The LEDs' and an internal chip diode's I-V characteristics are routinely measured, digitized, and mapped to  $\Delta$ PWM code adjustments stored in three integrated Luminosity vs. Temperature (LUT) lookup tables. Each LUT is assigned to one LED bank with two LED current drivers each. By default, banks A, B, and C are assigned to Blue, Green, and Red LEDs respectively. Additionally, the same LUTs can be used to insure current or power de-rating curve vs. temperature.

Figure A1.1 shows an actual Luminosity vs. Temperature curve of the NSSM038AT-E RGB LED available from Nichia Corp.

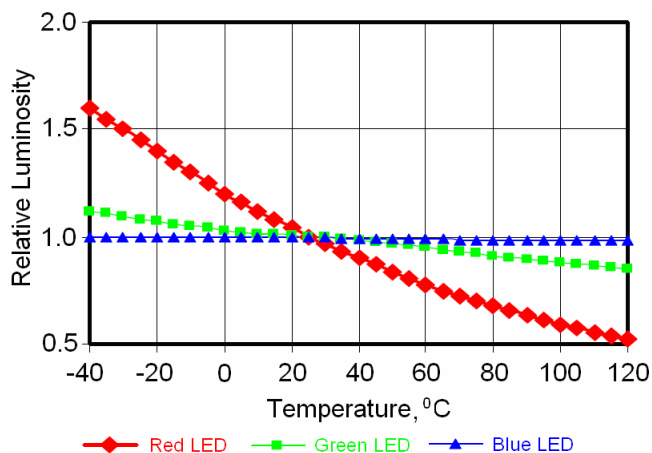

Figure A1.1: Luminosity vs. Temperature curve (NSSM038AT-E RGB LED from Nichia)

Figure A1.2 shows the total power (combined R, G, and B diodes) specification and de-rating for this RGB LED.

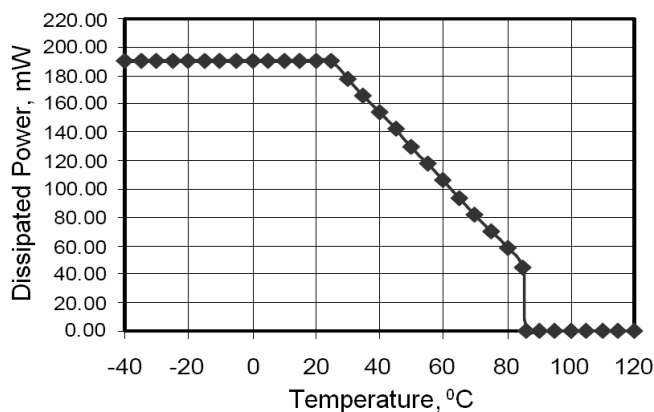

Figure A1.2: Total power (combined R, G, and B diodes) de-rating curve (NSSM038AT-E RGB LED from Nichia)

Assuming that compensation should maintain Relative Luminosity = 1 in full range of temperatures, the Compensation curve should be an inversion of the Luminosity vs. Temperature curve shown at Figure 1 (see Figure A1-3).

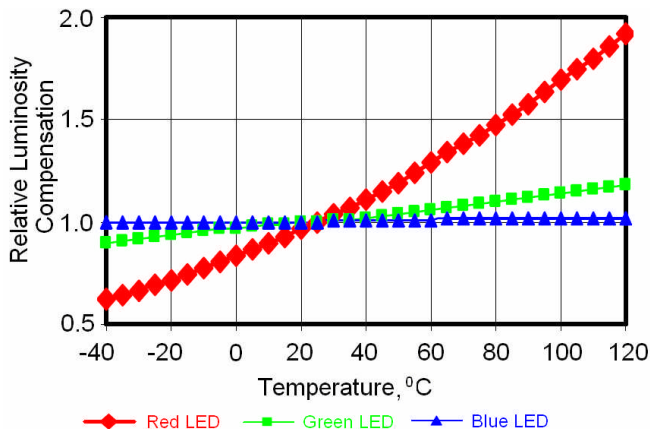

Figure A1.3: Relative Luminosity Compensation Curve (inverse Luminosity vs. Temperature curve) NSSM038AT-E RGB LED from Nichia

This characteristic must be fitted to the chosen nominal current at 25°C. Then the maximum current operating point is established and it must comply with the specified temperature de-rating curves for the LEDs.

Figure A1.5 represents LED Current vs. Temperature curve created for NSSM038AT-E RGB LED with 15ma chosen as the nominal current at 25°C, and a maximum power for the RGB LED of ~ 133mW as depicted in Figure A1.4 showing the user-selected de-



rating curve. The user operating point must comply within the specification in Figure 2.

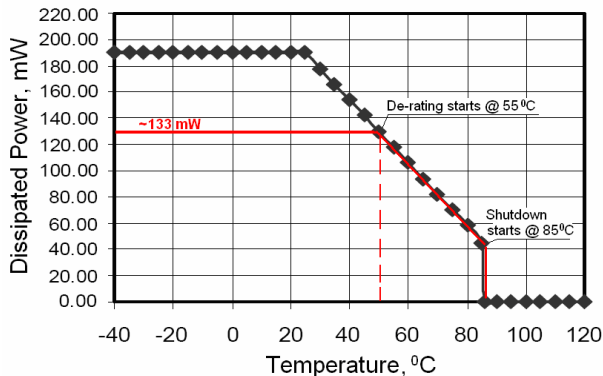

Figure A1.4: User Chosen Power and De-rating Curve starting at 55°C and shutdown at 85°C

The maximum current of ~ 18mA for the Red LED is limited by power dissipation at 50°C and decreases at higher temperatures in respect to the de-rating specification of Figure A1.2.

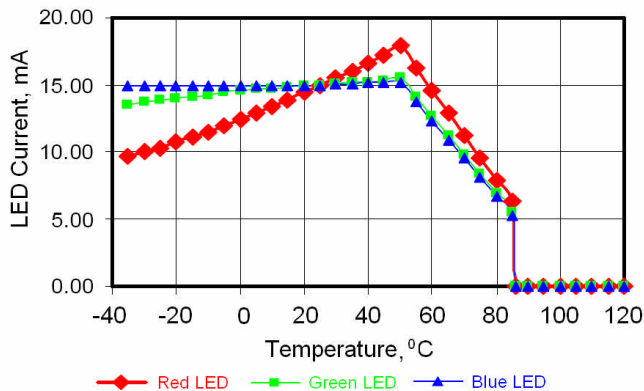

Figure A1.5: LED Current Correction Curves with de-rating start at 55°C and shutdown at 85°C

The LED Current vs. Temperature curves are then mapped to LDS8160  $\Delta$ PWM duty cycle codes that are loaded into each of the three LUTs as 32 4-bit words. Each word can represent from +7 to -7  $\Delta$ PWM steps for every 5°C temperature increment. The  $\Delta$ PWM codes are loaded into registers 50h – 7Fh as 4-bit two's complement values (see Table 7 of main LDS8160 datasheet for code allocation).

To maintain correlation to typical LED vendor data, the tables establish 25°C as the zero-reference point. Therefore, "0" is the required  $\Delta$ PWM code value for 25°C. For temperatures above 25°C, the  $\Delta$ PWM codes is the delta step change from the 5°C temperature point lower than the current step, while for temperatures below 25°C the  $\Delta$ PWM code is the delta step change from the 5°C temperature higher than the current step (i.e. closer to 25°C). The

compensation temperature range is from -35 to 120°C.

Example:

If  $\Delta$ PWM codes for the Red LED at 35°C are 0001 (1 step) and at 40°C 0010 (2 steps), register 77h should be loaded with code 0010 0001 (bin) = 21h.

The LDS8160 has three integrated PWM generators that allow programming of 256 logarithmic steps with 12-bit resolution in the LOG mode. Each PWM step is ~ 0.17 dB from 300uA to 25mA in the 1-x scale mode and therefore ~ 0.34 dB in the 2-x scale mode.

1-x scale is typically used in the temperature correction/compensation part of curve (as shown in Figure 5) A 2-x scale mode is also available to support the higher de-rating slope requirements

The LOG mode is required for RGB correction.

Linear mode operation and linear mode LUT correction codes are an option in WLED applications. If Linear WLED mode is chosen, all PWM related data for Dynamic Dimming and Temperature Compensation are entered as linear step codes, where each  $\Delta$ PWM step is 1/256 of full brightness (100% Duty Cycle)

In WLED applications where Linear PWM option mode is chosen, only one PWM generator is active (i.e. the A or Blue channel). In Linear mode the PWM is 8-bit linear resolution where each bit represents is 1/256 of 100% duty cycle.

### Example: RGB LUT Table Generation

Assume that the desired nominal forward current at 25°C is 15 mA at all three LEDs and the forward voltages for the R, G, B LEDs are ~ 2.1 V, 3.2 V, and 3.2 V, respectively (per NSSM038AT-E datasheet).

If selected de-rating starts at 50°C, LED current values at this temperature would be (per the Luminosity Compensation Curve at Figure 3):

- ~ 1.2x the nominal value at 25°C, i.e.  $15 \times 1.2 = 18$  mA for Red LED;
- ~ 1.04X the nominal value at 25°C, i.e.  $15 \times 1.04 = 15.6$  mA for Green LED;
- ~ 1x the nominal value for Blue LED to maintain constant luminosity over temperature.

Users must also determine the typical forward voltage vs. Temperature coefficients, or "k" factors, of the LEDs used @ 1mA of forward current.

For the Nichia NSSM038AT-E these have been determined as;

- 2.0 mV/°C for RED LED,
- 1.5 mV/°C for Green LED, and
- 1.3 mV/°C for Blue LED.

Therefore, at 50°C, forward voltages are  $V_F = 2.1V + [-2.0 \text{ mV/}^\circ\text{C} \times (50^\circ\text{C} - 25^\circ\text{C})] = 2.05V$  for Red

## LED

$V_F = 3.2V + [-1.5 \text{ mV}/^\circ\text{C} \times (50^\circ\text{C} - 25^\circ\text{C})] = 3.163V$  for Green LED, and

$V_F = 3.2V + [-1.3 \text{ mV}/^\circ\text{C} \times (50^\circ\text{C} - 25^\circ\text{C})] = 3.168V$  for Blue LED.

The total RGB LED power at a  $50^\circ\text{C}$  with the applied inverse curves to equalize the luminosity vs. temperature would be

$$(2.05V \times 18\text{mA}) + (3.16V \times 15.6\text{mA}) + (3.17V \times 15\text{mA}) \approx 133\text{mW}$$

The total RGB LED power for NSSM038AT-E must be less than  $\sim 133\text{mW}$  up to the de-rating point at  $50^\circ\text{C}$  (see Figure 2) complies with our result.

Also from the curve in Figure 2, the total power must de-rate to  $\sim 45\text{mW}$  at  $85^\circ\text{C}$  and diodes must be turned off at higher temperatures.

At  $85^\circ\text{C}$ , the R, G, B forward voltages will be reduced to  $\sim 1.98V$ ,  $3.11V$ , and  $3.12V$  respectively.

The de-rating is achieved by decreasing LED currents in constant steps (i.e. linear rate) from  $50^\circ\text{C}$  to  $85^\circ\text{C}$  to meet the final  $45\text{mW}$  power dissipation.

To maintain the luminosity equalization during the de-rating, the  $50^\circ\text{C}$  current ratios between Red, Green, and Blue LED currents (i.e. 1.2:1.04:1) should be preserved.

With nominal forward current,  $I = 15\text{mA}$ , and maintaining the  $50^\circ\text{C}$  current ratios, the B-LED current at the end of de-rating (before shutdown) is calculated as follows;

The total power dissipated by RGB LEDs at  $85^\circ\text{C}$  is  $P_{85C} = (1.2 \times I \times V_{R_{85C}}) + (1.04 \times I \times V_{G_{85C}}) + (1 \times I \times V_{B_{85C}}) = (1.2 \times I \times 1.98V) + (1.04 \times I \times 3.11V) + (1 \times I \times 3.12V) = 45\text{mW}$ , where  $I$  is the Blue LED current at  $85^\circ\text{C}$ .

Solving for  $I$  gives us  $I = \sim 45\text{mW} / 8.73V = 5.16\text{mA}$  for Blue,  $5.37\text{mA}$  for Green, and  $6.19\text{mA}$  for Red LED.

$I_R$  must de-rate from  $18\text{mA}$  to  $\sim 6.19\text{mA}$  from  $50^\circ\text{C}$  to  $85^\circ\text{C}$  (seven  $5^\circ\text{C}$  steps).

For linear de-rate, each step is  $18\text{mA} - 6.19\text{mA} / 7 = \sim 1.69\text{mA}/\text{step}$ . Using the 2-x  $\Delta\text{PWM}$  code scale, this is met with the codes shown in the R-LUT table (See Table 8 of LDS8160 datasheet) from  $55^\circ\text{C}$  to  $85^\circ\text{C}$ .

In LOG mode the  $\Delta\text{PWM}$  table entries for the de-rating are found by first taking the current of the prior step minus the de-rating current per step, then dividing the result by the prior step current, and finally converting to a number of dB step.

The following example clarifies:

Using prior data for RED LED, we will find required de-rating  $\Delta R$  in dB at  $55^\circ\text{C}$

$$\Delta R @ 55^\circ\text{C} = 20\text{Log} [(18\text{mA} - 1.69\text{mA}) / 18\text{mA}] = -0.856\text{dB},$$

where  $18\text{mA}$  is the current for the  $50^\circ\text{C}$  point and  $1.69\text{mA}$  is the de-rating current for each  $5^\circ\text{C}$ .

Dividing this value by  $0.34\text{dB}/\text{step}$  (in 2-x scale used for de-rating) and rounding result to the nearest integer value give us follow  $\Delta\text{PWM}$  code

$$\Delta\text{PWM} = \text{INT} (-0.846\text{dB} / 0.34\text{dB}/\text{step}) = -3 = 1101\text{ (bin)}$$

(see Table 8 of LDS8160 datasheet).

The  $\Delta\text{PWM}$  value would then be

$$\Delta\text{PWM} @ 60^\circ\text{C} = \text{INT} \{20\text{Log} [(16.31\text{mA} - 1.69\text{mA}) / 16.31\text{mA}] / 0.34\} = -3 = 1101\text{ (bin)}$$

$$\Delta\text{PWM} @ 65^\circ\text{C} = \text{INT} \{20\text{Log} [(14.62\text{mA} - 1.69\text{mA}) / 14.62\text{mA}] = -3 = 1101\text{ (bin)}$$

$$\Delta\text{PWM} @ 70^\circ\text{C} = \text{INT} \{20\text{Log} [(12.93\text{mA} - 1.69\text{mA}) / 12.93\text{mA}] = -4 = 1100\text{ (bin)}$$

$$\Delta\text{PWM} @ 75^\circ\text{C} = \text{INT} \{20\text{Log} [(11.24\text{mA} - 1.69\text{mA}) / 11.24\text{mA}] = -4 = 1100\text{ (bin)}$$

$$\Delta\text{PWM} @ 80^\circ\text{C} = \text{INT} \{20\text{Log} [(9.55\text{mA} - 1.69\text{mA}) / 9.55\text{mA}] = -5 = 1011\text{ (bin)}$$

$$\Delta\text{PWM} @ 85^\circ\text{C} = \text{INT} \{20\text{Log} [(7.86\text{mA} - 1.69\text{mA}) / 7.86\text{mA}] = -6 = 1010\text{ (bin)}$$

At temperatures higher than  $85^\circ\text{C}$ , the LED current should be zero mA due to the shutdown temperature defined as above  $85^\circ\text{C}$ . Therefore, LUT  $\Delta\text{PWM}$  entries for shutdown regions are not used and may be zero.

To set LED current in shutdown at temperature above  $85^\circ\text{C}$ , write  $85^\circ\text{C}$  T-code (11000 (bin)) with leading 1, i.e. 111000 (bin) = 38h, into register 4Ah (see Table 7 of LDS8160 datasheet).

To maintain constant ratio between channels during the de-rating, the Green and Blue channels can de-rated by the same dB steps in Logarithmic mode as the Red channel. This will maintain the same luminosity balance as at the starting point of the de-rating.

Users can adjust luminosity balance in the de-rating section too to further optimize balance. This requires more customized table entries (i.e. ratios continue to match Luminosity vs. Temperature curve even for temperatures where de-rating is being applied). The decided approach is user/application dependent.

Table A1.1 shows the completed table used as LDS8160 default for Nichia NSSM038AT-E RGB LED with the assumptions overviewed in this example.

To aid users in building and loading their specific correction tables IXYS can provide a software development tool to map LED vendor information and user defined operating points to final calculated LUT data values. Please consult factory to obtain a copy.

Figure A1.6 shows the effective curve formed by the accumulated  $\Delta$ PWM codes.

The curves in the accumulated  $\Delta$ PWM codes should have same slope characteristics as the curves in Figure A1.5.

For WLED applications the Luminosity vs. Temperature characteristics are similar to Blue LEDs with the added effects of the yellow phosphor coatings applied. In general, Luminosity of WLEDs remains flat with temperature changed, but still requires high temperature de-rating.

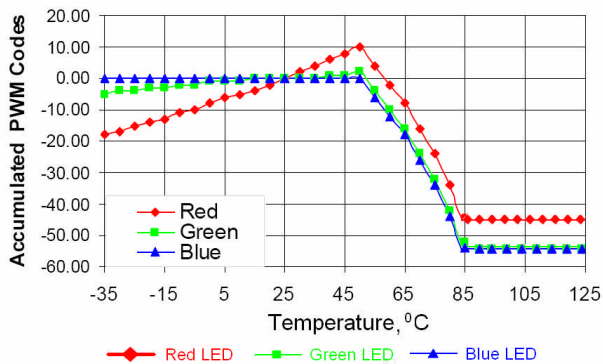

Figure A1.6: Accumulated  $\Delta$ PWM Correction Codes

Typically, a single  $\Delta$ PWM LUT correction table can be used for all WLEDs.  $\Delta$ PWM codes for the correction table are calculated similarly to RGB with de-rating start at 55°C and shutdown at 85°C

codes. The option for Linear Mode will adjust the code entries and calculations accordingly.

Using the LDS8160 temperature compensation capability to de-rate LEDs automatically, allows the LED to be operated at maximum luminosity levels (higher currents) and can reduce the total number of LEDs required and/or reduce the total LED system level power over systems that do not employ LED temperature compensation. Figure A1.7 depicts this.

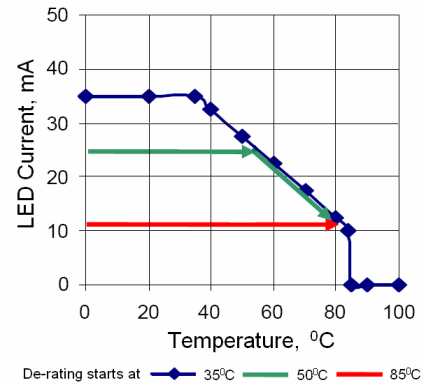

Figure A1.7: Allowable LED Forward Current vs. Temperature  
(WLED NSSW020BT-P1 from Nichia)

Table A1.1: RGB  $\Delta$ PWM LUT tables for this Nichia NSSM038AT-E device with 15mA nominal current at 25<sup>0</sup>C

Temperature	Red T-code	Green T-code	Blue T-code	Scale
-35	-1	-1	0	1-x
-30	-2	0	0	1-x
-25	-1	-1	0	1-x
-20	-1	0	0	1-x
-15	-2	-1	0	1-x
-10	-1	0	0	1-x
-5	-2	-1	0	1-x
0	-2	0	0	1-x
5	-1	0	0	1-x
10	-1	-1	0	1-x
15	-2	0	0	1-x
20	-2	0	0	1-x
25	0	0	0	1-x
30	2	0	0	1-x
35	2	0	0	1-x
40	2	1	0	1-x
45	2	0	0	1-x
50	2	1	0	1-x
55	-3	-3	-3	2-x*
60	-3	-3	-3	2-x
65	-3	-3	-3	2-x
70	-4	-4	-4	2-x
75	-4	-4	-4	2-x
80	-5	-5	-5	2-x
85	-6	-6	-6	2-x
86	0	0	0	Shutdown**
90	0	0	0	Shutdown
95	0	0	0	Shutdown
100	0	0	0	Shutdown
105	0	0	0	Shutdown
110	0	0	0	Shutdown
115	0	0	0	Shutdown
120	0	0	0	Shutdown

**Note:**

\*) Register 4Bh should be loaded with bit 5 = 1 and bits from Bit 4 to Bit 0 with T-code at 55<sup>0</sup>C (10011 (bin)), i.e. register 4Bh should be addressed with data 11 0011 (bin) = 33h (see Table 7 of LDS8160 datasheet).

\*\*) Register 4Ah should be loaded with bits from Bit 4 to Bit 0 with T-code at 85<sup>0</sup>C (11000 (bin)), i.e. register 4Bh should be addressed with data 11000 (bin) = 18h (see Table 7 of LDS8160 datasheet).

## Appendix 2

### ADJUSTMENTS FOR RGB WHITE BALANCE

The LDS8160 allows two ways for LED current setting. One of them is using registers 00h – 02h (static mode) and other one by using PWM signal to decrease average LED current value set by these registers (dynamic mode). For dynamic mode, the LDS8160 integrates 3 digital PWM generators that operate at a frequency of ~ 285 Hz. In Logarithmic Mode (which is required for RGB applications), the PWM generators are 12-bit resolution and can be programmed with an 8-bit code to provide 256 internally mapped 12-bit logarithmic duty cycle steps to adjust the dimming level. In Linear Mode, the PWM generates 256 linear duty cycle steps to adjust the dimming levels from the user programmed 8-bit code. The Linear Mode is not recommended for RGB LED applications that require color mixing, and is useful for WLED or other single color LED applications).

The advantage of PWM dimming is stable LED color temperature / wavelength that are determined by the maximum LED current value set by registers 00h – 02h.

To use the dynamic PWM mode for LED current setting, the maximum  $I_{LED}$  value should be set by registers 00h – 02h as described above in static mode and desired dimming should be set by registers 05h – 07h. In Logarithmic Mode, set by default, dimming resolution is approximately -0.17 dB per step with 0dB dimming at the 256<sup>th</sup> step.

In this example based on data from Appendix 1, it is chosen that all 3 channels (RGB) operate at 15 mA at 25°C temperature and do not exceed 133 mW of total power dissipation prior to temperature de-rating at more than 50°C. Since the maximum current for Red channel is 18mA @ 50°C, we assume that all static LED currents could be set to 18mA and the average 15 mA current achieved by applying Dynamic Dimming with PWM Duty Cycle  $15\text{ mA} / 18\text{ mA} = 83.3\%$ . This allows sufficient range for temperature compensation with  $\Delta$ PWM adjustments steps.

However, this equal current setting at 25°C may not meet requirements for RGB white balance color mixing. A typical color balance ratio for RGB diodes is given in the Nichia Application Note “Balancing White Color.” Here for white light at  $x = 0.33$  and  $y = 0.33$  on the (x, y) chromaticity curve (see Figure A2.1), the luminous intensity ratios for R:G:B = 3:7:1.

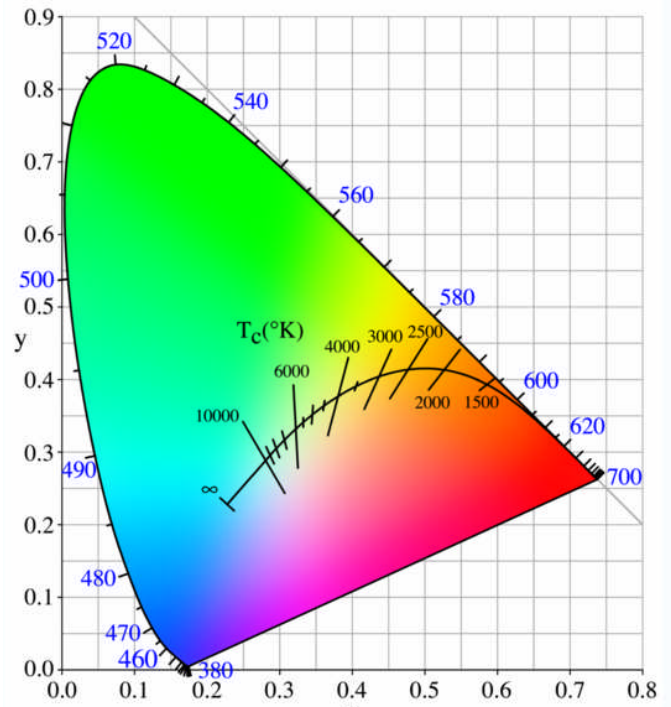

Figure A2.1: Chromaticity Curve

Nichia specifies the NSSM038AT-E RGB diode luminous intensities of 550 mcd for Red, 1100 mcd for Green, and 240 mcd for Blue, all at 20mA of current. Also per the NSSM038AT-E datasheet, relative luminosity vs. forward current is ~ 1:1:1 for current below 25mA.

Therefore for current of 15mA, luminous intensity levels are  $15\text{ mA} / 20\text{ mA} = 0.75$  of the 20mA specified level, i.e. luminous intensity is 412 mcd for Red, 825 mcd for Green, and 180 mcd for Blue, that gives us intensity ratio 2.3:4.6:1.

To achieve the desired white balance at intensity ratio 3:7:1, forward current levels for each color channel should be adjusted. If the maximum intensity for Green LED is 825 mcd at 15mA current, the intensity of other LEDs should be  $825 \times 3/7 = 354$  mcd for Red and  $825 \times 1/7 = 118$  mcd for Blue. That responds to the following LED currents:  $354/412 \times 15\text{ mA} = 12.9\text{ mA}$  for Red LED, and  $118/180 \times 15\text{ mA} = 9.8\text{ mA}$  for Blue LED.

This could be achieved via adjustment to the user-set Dynamic Dimming levels for each channel.

Since Green LED has the highest intensity, all static LED currents should be set equal to the Green LED maximum forward current at 15.6 mA instead of 18 mA as we assume previously. Then to insure 15 mA

nominal current setting for **Green** at 25°C, set the **Green** Dynamic Dimming PWM level for 15 mA / 15.6 mA x 100% = 96% duty cycle. This insures sufficient range for temperature correction. Then the PWM Duty Cycle would be at 12.9 mA / 15.6 mA = ~ 82.7% for **Red** LED and 9.8 mA / 15.6 mA = 62.8% for **Blue** LED.

Note: maximum **Red** LED current at 5°C would be  $1.2 * 12.9 \text{ mA} = 15.48 \text{ mA}$ , so the maximum current of 15.6 mA is sufficient to meet the **Red** temperature compensation requirements.

This approach uses same static DC current to establish the "base" chromaticity point of the LEDs. Color mixing is then performed with PWM adjustment without any additional color shifts.

A second approach is to establish the white balance ratio at maximum current using the static LED current settings.

In this approach **Green** LED current would be set for **15.6mA**, while **Red** LED current would be  $15.6 \text{ mA} / 15 \text{ ma} * 12.9 \text{ mA} = 13.4 \text{ mA}$ , and **Blue** LED current  $15.6 \text{ mA} / 15 \text{ mA} * 9.8\text{mA} = 10.2\text{mA}$ . The PWM Dynamic Dimming level could then be set at 96% Duty Cycle for all three channels to meet the 15 mA for **Green** at 25°C. Further dimming needs could use the Global PWM Dimming feature.

As can be seen, adjusting for white balance can reduce overall power levels from the chosen 133 mW (in this example). Different maximum current level points could be chosen to increase overall luminosity level and still meet total 133 mW power level.

These choices are user/application dependent. The approach overviewed in the example can be applied to other RGB LEDs.

## Appendix 3

### LED TEMPERATURE MEASUREMENT

To implement the temperature correction of the  $I_{LED}$  vs. Temperature in respect to compensation curve, the LED temperature should be known.

A very common and reliable method of measuring temperature in integrated circuits is to take advantage of the forward voltage ( $V_F$ ) behavior of a P-N junction semiconductor diode with respect to temperature.

At any given current, the forward voltage ( $V_F$ ) of a P-N junction diode is

$$V_F = \frac{\eta(kT)}{q} \times \ln\left(\frac{I_F}{I_S}\right) \quad (1)$$

Where:

$\eta$  = ideality factor; ~ 1 for silicon

$k$  = Boltzmann constant =  $1.38 \times 10^{-23}$  (Joules)/deg K

$q$  = Charge of electron =  $1.602 \times 10^{-19}$  coulombs

$T$  = Absolute Temperature, deg K

$I_F$  = the diode forward current, A

$I_S$  = the diode reverse saturation current, A.

LEDs, based on compound semiconductors other than silicon structures, have complex dependency between forward voltage and current

$$V_{F\_LED} = \frac{E_g}{q} + \frac{\eta kT}{q} \ln\left(\frac{I_F}{I_S}\right) + R_S I_F \quad (2)$$

Where

$R_S$  – is LED series resistance,  $\Omega$ ,

$E_g$  – is the bandgap energy of the material that

determines the wavelength of emitted light  $E_g = \frac{hc}{\lambda}$ ,

$h = 6.626 \times 10^{-34}$  (Joules x s) - is Planck's constant;

$c = 3.0 \times 10^8$  m/s - is the speed of light;

$\lambda$  = wavelength in m

The problem with measuring  $V_F$  directly is that the  $I_S$  term is highly temperature dependent and very difficult to measure or predict. Additionally, generating a precise current that does not vary with power supply, processing variations and temperature is also very difficult.

Measuring  $V_F$  at two separate forward currents,  $I_{F2}$  and  $I_{F1}$  allows avoiding these issues. Due to the nature of logarithms, the difference,  $\Delta V_F$ , between the two measurements will be linearly dependent on temperature, and the  $I_S$  terms will cancel. In addition, the linear term is a function of a ratio of currents that are relatively straightforward to implement and independent of the operating conditions. This temperature measurement method is also known as

the PTAT (proportional to absolute temperature) technique, as the  $\Delta V_F$  has a linear and positive (proportional) tracking coefficient with temperature.

$$\Delta V_F = \frac{\eta kT}{q} \ln\left(\frac{I_{F2}}{I_{F1}}\right) + R_S (I_{F2} - I_{F1}) \quad (3)$$

A second method for diode temperature sensing measures the diode  $V_F$  at two different temperatures ( $T_1$  and  $T_2$ ) at a constant  $I_F$ , and it is also commonly employed.

This is referred to as the CTAT (complementary to absolute temperature) technique as the  $V_F$  has a linear but negative (complementary) tracking rate with temperature. This method requires that the  $V_F$  temperature coefficient be pre-characterized.

The LDS8160 utilizes both techniques for improved temperature estimation accuracy. A proprietary digital arbitration algorithm resolves the final temperature estimation every 2.5 seconds from both techniques and a combination of on-chip silicon diode and LED device measurements.

The ideality factor term,  $\eta$ , is based on the physical properties of the diode construction and directly relates to the recombination leakage current caused by defects. For an ideal diode  $\eta = 1$ , and the  $V_F$  increases at the rate of 60 mV per decade change in  $I_F$ . Non-ideal P-N junctions (i.e. LEDs) have  $\eta > 1$ ; therefore the change in  $V_F$  increases more per decade change in  $I_F$ .

This factor varies across manufactures and devices, and it requires a calibration before direct temperature sensing of the LEDs. The ideality factor  $\eta$  may be determined as the slope of the logarithmic  $I$  vs.  $V$  diode characteristic in the low operating current region (where effects of  $R_S$  are negligible).

Series resistance,  $R_S$ , is another non-ideal characteristic. LEDs typically operate at forward currents in the range of several of milliamps, therefore, LEDs series resistance in the range of 10's of ohms results in a significant deviation from ideal behavior. The actual  $R_S$  value can be extracted from the logarithmic  $I$  vs.  $V_F$  curve of the diode in the high current operating region.

Figure A3.1 shows a curve that represents a Nichia WLED (NSSW020BT-P1) used for mobile display backlighting. The  $R_S$  value extracted from this curve is  $\sim 17 \Omega$  and  $\eta = \sim 1.55$ .

For comparison, the second curve is the “ideal” curve obtained if  $\eta = 1$  and  $R_s = 0$  (with the same  $V_F$  turn on voltage).

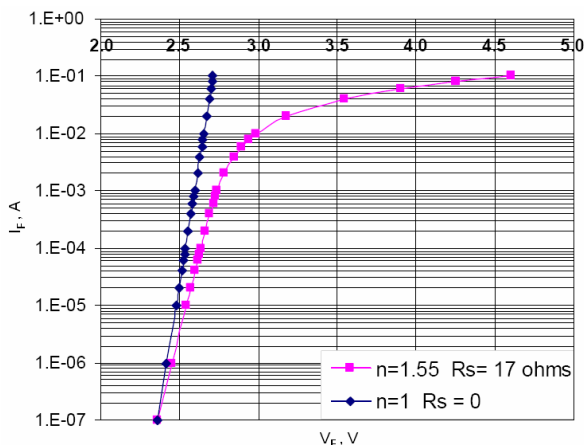

Figure A3.1: I-V characteristic for Nichia WLED diode (NSSW020BT-P1)

The LDS8160 implements LED temperature measurement using two low currents during PWM off time. Low currents are used to avoid error due high LED’  $R_s$  value and LED heating during measurement. The sampling time is  $\sim 125\mu\text{sec}$  per LED sensed every 2.5 sec. The interruption and change in the average LED current is  $\sim 0.015\%$  in the sampling period and  $\sim 0.6\%$  error in the local 20msec time window of the measured sample. This is below the level to have any visual effect.

LDS8160 allows LED sensing on three LED driver channels (1 per each bank or color channel). The temperature may be measured on any LED (R, G, B, WLED, or other) connected to the LEDA1, LEDB1, or LEDC1 driver channels. This allows users to determine the junction temperature for one LED for each of the three Banks (or color channels).

Additional correction, based on measurements of an on-chip silicon diode’s temperature data, improves measurement precision.

The LDS8160 performs a calibration routine at start-up to determine the ideality factor  $\eta$  for the LEDs used. In addition, this calibration process may be conducted at user (system) defined operating points.

During the calibration sequence, the junction temperature  $T_j$  of the on-chip silicon diode is measured and the ambient temperature  $T_a$  is obtained by applying a stored offset between  $T_j$  and  $T_a$ . This offset depends on LDS8160 package thermal resistance, the user selected operating condition, and the device power levels during the calibration sequence. Factory defaults are provided but can be reprogrammed by the user.

A thermal related package offset for the LEDs must also be stored (based on LED vendor thermal data) to further correlate LED  $T_j$  with the silicon diode  $T_j$  and the  $T_a$  during the calibration process.

This additional LED based package offset should be loaded by the user, based on user’s selection of LEDs and operating conditions during the desired calibration sequence.

The user decides the operating condition for running the calibration sequence, and initiates a calibration command by writing bit 4 of Register 1Fh to “1” (the bit resets automatically upon completion).

If the calibration starts prior to setting currents to the LEDs, (i.e. after the power-on initialization sequence for the LDS8160), then during the calibration period, we assume that the ambient temperature,  $T_a$ , is the same for both the on-chip diode and the LEDs (since no DC current flow in LEDs, there is no appreciable temperature offset incurred).

The LEDs also have a typical offset between junction and ambient temperature, which is applied to obtain the reference LED  $T_j$  used for calibrating the ideality factor as prior discussed.

The LDS8160 is delivered with factory-preset values, however, the user must load LED specific parameters and recommended factory values for the internal silicon diode.

$T_a$ - $T_j$  Temperature Offset adjustment for silicon diode – register 49h, bit3 – bit0 (every LSB is equal  $5^\circ\text{C}$  offset, with  $+35^\circ\text{C}$  to  $-40^\circ\text{C}$  range);

$T_a$ - $T_j$  Temperature Offset for LEDs – register 49h, bit7 – bit4 (every LSB is equal  $5^\circ\text{C}$  offset, with  $+35^\circ\text{C}$  to  $-40^\circ\text{C}$  range);;

Silicon diode  $V_F$  temperature coefficient – register A0h, bit 7 – bit0; factory recommended load value is  $-1.71 \text{ mV}/^\circ\text{C} = 00110110$  (bin) = 36h

Silicon diode ideality coefficient – register C0h; factory recommended load values is  $1.000 = 01000000$ (bin) = 40h

Temperature Offset between  $T_j$  and  $T_a$  for LED – register D0h (user loaded) - correction from ambient temperature to LED junction temperature; factory default = 04h.

Temperature Offset between  $T_j$  and  $T_a$  for silicon diode – register D2h, correction for LDS8160 package thermal characteristics; factory default = 02h.

LEDs  $R_s$  value (user loaded) for Banks A, B, and C registers D6h, D8h, and DAh respectively.



## Appendix 4 LDS8160 Dynamic PWM Dimming Codes (1/Duty Cycle)

Table A4.1 Dynamic Mode Dimming in Logarithmic Mode vs. registers 05h – 07h data

# of steps	Hex code	Dimming, dB	Dimming, %	# of steps	Hex code	Dimming, dB	Dimming, %	# of steps	Hex code	Dimming, dB	Dimming, %
0	00		100	32	20	-41.9	99.19	64	40	-32.6	97.63
1	01	-72.3	99.98	33	21	-41.4	99.15	65	41	-32.4	97.58
2	02	-66.3	99.95	34	22	-40.9	99.10	66	42	-32.2	97.53
3	03	-62.8	99.93	35	23	-40.5	99.05	67	43	-32.1	97.49
4	04	-60.3	99.90	36	24	-40.1	99.00	68	44	-31.9	97.44
5	05	-58.3	99.88	37	25	-39.6	98.95	69	45	-31.7	97.39
6	06	-56.7	99.85	38	26	-39.2	98.90	70	46	-31.6	97.34
7	07	55.4	99.83	39	27	-38.9	98.85	71	47	-31.4	97.29
8	08	-54.3	99.80	40	28	-38.5	98.80	72	48	-31.3	97.24
9	09	-53.2	99.78	41	29	-38.2	98.75	73	49	-31.1	97.19
10	0A	-52.3	99.76	42	2A	-37.8	98.71	74	4A	-30.9	97.14
11	0B	-51.5	99.73	43	2B	-37.5	98.66	75	4B	-30.8	97.09
12	0C	-50.7	99.71	44	2C	-37.2	98.61	76	4C	-30.7	97.05
13	0D	-50	99.68	45	2D	-36.9	98.56	77	4D	-30.5	97.00
14	0E	-49.4	99.66	46	2E	-36.6	98.51	78	4E	-30.4	96.95
15	0F	-48.8	99.63	47	2F	-36.3	98.46	79	4F	-30.2	96.90
16	10	-48.2	99.61	48	30	-36.1	98.41	80	50	-30.1	96.85
17	11	-47.7	99.58	49	31	-35.8	98.36	81	51	-30	96.80
18	12	-47.2	99.56	50	32	-35.5	98.32	82	52	-29.8	96.75
19	13	-46.7	99.54	51	33	-35.3	98.27	83	53	-29.7	96.70
20	14	-46.3	99.51	52	34	-35	98.22	84	54	-29.6	96.66
21	15	-45.9	99.49	53	35	-34.8	98.17	85	55	-29.5	96.61
22	16	-45.5	99.46	54	36	-34.6	98.12	86	56	-29.3	96.56
23	17	-45.1	99.44	55	37	-34.4	98.07	87	57	-29.2	96.51
24	18	-44.7	99.41	56	38	-34.1	98.02	88	58	-29.1	96.46
25	19	-44.4	99.39	57	39	-33.9	97.97	89	59	-29	96.41
26	1A	-44	99.37	58	3A	-33.7	97.92	90	5A	-28.8	96.36
27	1B	-43.7	99.34	59	3B	-33.5	97.88	91	5B	-28.7	96.31
28	1C	-43.4	99.32	60	3C	-33.3	97.83	92	5C	-28.6	96.26
29	1D	-43.1	99.29	61	3D	-33.1	97.78	93	5D	-28.5	96.22
30	1E	-42.8	99.27	62	3E	-32.9	97.73	94	5E	-28.4	96.17
31	1F	-42.5	99.24	63	3F	-32.8	97.68	95	5F	-28.3	96.12

Continued

Table A4.1 Dynamic Mode Dimming in Logarithmic Mode vs. registers 05h – 07h data

Continue

# of steps	Hex code	Dimming, dB	Dimming, %	# of steps	Hex code	Dimming, dB	Dimming, %	# of steps	Hex code	Dimming, dB	Dimming, %
96	60	-28.1	96.02	128	80	-22.9	92.80	160	A0	-17.4	86.35
97	61	-27.9	95.92	129	81	-22.7	92.60	161	A1	-17.1	85.96
98	62	-27.7	95.83	130	82	-22.5	92.41	162	A2	-16.9	85.57
99	63	-27.5	95.73	131	83	-22.2	92.21	163	A3	-16.6	85.18
100	64	-27.3	95.63	132	84	-22	92.02	164	A4	-16.4	84.79
101	65	-27.1	95.53	133	85	-21.8	91.82	165	A5	-16.2	84.40
102	66	-26.9	95.43	134	86	-21.6	91.63	166	A6	-16	84.01
103	67	-26.7	95.34	135	87	-21.4	91.43	167	A7	-15.8	83.62
104	68	-26.5	95.24	136	88	-21.2	91.24	168	A8	-15.6	83.23
105	69	-26.3	95.14	137	89	-21	91.04	169	A9	-15.4	82.84
106	6A	-26.2	95.04	138	8A	-20.8	90.84	170	AA	-15.2	82.45
107	6B	-26	94.95	139	8B	-20.6	90.65	171	AB	-15	82.06
108	6C	-25.8	94.85	140	8C	-20.5	90.45	172	AC	-14.8	81.67
109	6D	-25.7	94.75	141	8D	-20.3	90.26	173	AD	-14.6	81.27
110	6E	-25.5	94.65	142	8E	-20.1	90.06	174	AE	-14.4	80.88
111	6F	-25.3	94.56	143	8F	-20	89.87	175	AF	-14.3	80.49
112	70	-25.2	94.46	144	90	-19.8	89.67	176	B0	-14.1	80.10
113	71	-25	94.36	145	91	-19.6	89.48	177	B1	-13.9	79.71
114	72	-24.9	94.26	146	92	-19.5	89.28	178	B2	-13.8	79.32
115	73	-24.7	94.17	147	93	-19.3	89.09	179	B3	-13.6	78.93
116	74	-24.6	94.07	148	94	-19.2	88.89	180	B4	-13.4	78.54
117	75	-24.5	93.97	149	95	-19	88.70	181	B5	-13.3	78.15
118	76	-24.3	93.87	150	96	-18.9	88.50	182	B6	-13.1	77.76
119	77	-24.2	93.77	151	97	-18.7	88.31	183	B7	-13	77.37
120	78	-24	93.68	152	98	-18.6	88.11	184	B8	-12.8	76.98
121	79	-23.9	93.58	153	99	-18.4	87.92	185	B9	-12.7	76.59
122	7A	-23.8	93.48	154	9A	-18.3	87.72	186	BA	-12.5	76.20
123	7B	-23.7	93.38	155	9B	-18.1	87.52	187	BB	-12.4	75.81
124	7C	-23.5	93.29	156	9C	-18	87.33	188	BC	-12.3	75.42
125	7D	-23.4	93.19	157	9D	-17.9	87.13	189	BD	-12.1	75.02
126	7E	-23.3	93.09	158	9E	-17.7	86.94	190	BE	-12	74.63
127	7F	-23.2	92.99	159	9F	-17.6	86.74	191	BF	-11.8	74.24

Continued

Table A4.1 Dynamic Mode Dimming in Logarithmic Mode vs. registers 05h – 07h data

Continue

# of steps	Hex code	Dimming, dB	Dimming, %	# of steps	Hex code	Dimming, dB	Dimming, %
192	C0	-11.6	73.46	224	E0	-5.7	47.68
193	C1	-11.3	72.68	225	E1	-5.4	46.12
194	C2	-11.1	71.90	226	E2	-5.2	44.56
195	C3	-10.9	71.12	227	E3	-4.9	42.99
196	C4	-10.6	70.34	228	E4	-4.7	41.43
197	C5	-10.4	69.56	229	E5	-4.5	39.87
198	C6	-10.2	68.77	230	E6	-4.3	38.31
199	C7	-10	67.99	231	E7	-4	36.74
200	C8	-9.8	67.21	232	E8	-3.8	35.18
201	C9	-9.5	66.43	233	E9	-3.6	33.62
202	CA	-9.3	65.65	234	EA	-3.4	32.06
203	CB	-9.2	64.87	235	EB	-3.2	30.49
204	CC	-9	64.09	236	EC	-3	28.93
205	CD	-8.8	63.31	237	ED	-2.8	27.37
206	CE	-8.6	62.52	238	EE	-2.7	25.81
207	CF	-8.4	61.74	239	EF	-2.5	24.24
208	D0	-8.2	60.96	240	F0	-2.3	22.68
209	D1	-8.1	60.18	241	F1	-2.1	21.12
210	D2	-7.9	59.40	242	F2	-2	19.56
211	D3	-7.7	58.62	243	F3	-1.8	17.99
212	D4	-7.6	57.84	244	F4	-1.6	16.43
213	D5	-7.4	57.06	245	F5	-1.5	14.87
214	D6	-7.3	56.27	246	F6	-1.3	13.31
215	D7	-7.1	55.49	247	F7	-1.2	11.74
216	D8	-6.9	54.71	248	F8	-1	10.18
217	D9	-6.8	53.93	249	F9	-0.8	8.62
218	DA	-6.7	53.15	250	FA	-0.7	7.06
219	DB	-6.5	52.37	251	FB	-0.6	5.49
220	DC	-6.4	51.59	252	FC	-0.4	3.93
221	DD	-6.2	50.81	253	FD	-0.3	2.37
222	DE	-6.1	50.02	254	FE	-0.1	0.81
223	DF	-6	49.24	255	FF	0	0.00

## Appendix 5 LDS8160 Global PWM Dimming Codes

Table A5.1 Global Dimming in Logarithmic Mode vs. register 04h data

# of steps	Hex code	Dimming, dB	Dimming, %	# of steps	Hex code	Dimming, dB	Dimming, %	# of steps	Hex code	Dimming, dB	Dimming, %
0	0	0	0.00	32	20	-6	49.24	64	40	-11.8	74.24
1	01	-0.1	0.81	33	21	-6.1	50.02	65	41	-12	74.63
2	02	-0.3	2.37	34	22	-6.2	50.81	66	42	-12.1	75.02
3	03	-0.4	3.93	35	23	-6.4	51.59	67	43	-12.3	75.42
4	04	-0.6	5.49	36	24	-6.5	52.37	68	44	-12.4	75.81
5	05	-0.7	7.06	37	25	-6.7	53.15	69	45	-12.5	76.20
6	06	-0.8	8.62	38	26	-6.8	53.93	70	46	-12.7	76.59
7	07	-1	10.18	39	27	-6.9	54.71	71	47	-12.8	76.98
8	08	-1.2	11.74	40	28	-7.1	55.49	72	48	-13	77.37
9	09	-1.3	13.31	41	29	-7.3	56.27	73	49	-13.1	77.76
10	0A	-1.5	14.87	42	2A	-7.4	57.06	74	4A	-13.3	78.15
11	0B	-1.6	16.43	43	2B	-7.6	57.84	75	4B	-13.4	78.54
12	0C	-1.8	17.99	44	2C	-7.7	58.62	76	4C	-13.6	78.93
13	0D	-2	19.56	45	2D	-7.9	59.40	77	4D	-13.8	79.32
14	0E	-2.1	21.12	46	2E	-8.1	60.18	78	4E	-13.9	79.71
15	0F	-2.3	22.68	47	2F	-8.2	60.96	79	4F	-14.1	80.10
16	10	-2.5	24.24	48	30	-8.4	61.74	80	50	-14.3	80.49
17	11	-2.7	25.81	49	31	-8.6	62.52	81	51	-14.4	80.88
18	12	-2.8	27.37	50	32	-8.8	63.31	82	52	-14.6	81.27
19	13	-3	28.93	51	33	-9	64.09	83	53	-14.8	81.67
20	14	-3.2	30.49	52	34	-9.2	64.87	84	54	-15	82.06
21	15	-3.4	32.06	53	35	-9.3	65.65	85	55	-15.2	82.45
22	16	-3.6	33.62	54	36	-9.5	66.43	86	56	-15.4	82.84
23	17	-3.8	35.18	55	37	-9.8	67.21	87	57	-15.6	83.23
24	18	-4	36.74	56	38	-10	67.99	88	58	-15.8	83.62
25	19	-4.3	38.31	57	39	-10.2	68.77	89	59	-16	84.01
26	1A	-4.5	39.87	58	3A	-10.4	69.56	90	5A	-16.2	84.40
27	1B	-4.7	41.43	59	3B	-10.6	70.34	91	5B	-16.4	84.79
28	1C	-4.9	42.99	60	3C	-10.9	71.12	92	5C	-16.6	85.18
29	1D	-5.2	44.56	61	3D	-11.1	71.90	93	5D	-16.9	85.57
30	1E	-5.4	46.12	62	3E	-11.3	72.68	94	5E	-17.1	85.96
31	1F	-5.7	47.68	63	3F	-11.6	73.46	95	5F	-17.4	86.35

Continued

Table A5.1 Global Dimming in Logarithmic Mode vs. register 04h data

Continue

# of steps	Hex code	Dimming, dB	Dimming, %	# of steps	Hex code	Dimming, dB	Dimming, %	# of steps	Hex code	Dimming, dB	Dimming, %
96	60	-17.6	86.74	128	80	-23.2	92.99	160	A0	-28.3	96.12
97	61	-17.7	86.94	129	81	-23.3	93.09	161	A1	-28.4	96.17
98	62	-17.9	87.13	130	82	-23.4	93.19	162	A2	-28.5	96.22
99	63	-18	87.33	131	83	-23.5	93.29	163	A3	-28.6	96.26
100	64	-18.1	87.52	132	84	-23.7	93.38	164	A4	-28.7	96.31
101	65	-18.3	87.72	133	85	-23.8	93.48	165	A5	-28.8	96.36
102	66	-18.4	87.92	134	86	-23.9	93.58	166	A6	-29	96.41
103	67	-18.6	88.11	135	87	-24	93.68	167	A7	-29.1	96.46
104	68	-18.7	88.31	136	88	-24.2	93.77	168	A8	-29.2	96.51
105	69	-18.9	88.50	137	89	-24.3	93.87	169	A9	-29.3	96.56
106	6A	-19	88.70	138	8A	-24.5	93.97	170	AA	-29.5	96.61
107	6B	-19.2	88.89	139	8B	-24.6	94.07	171	AB	-29.6	96.66
108	6C	-19.3	89.09	140	8C	-24.7	94.17	172	AC	-29.7	96.70
109	6D	-19.5	89.28	141	8D	-24.9	94.26	173	AD	-29.8	96.75
110	6E	-19.6	89.48	142	8E	-25	94.36	174	AE	-30	96.80
111	6F	-19.8	89.67	143	8F	-25.2	94.46	175	AF	-30.1	96.85
112	70	-20	89.87	144	90	-25.3	94.56	176	B0	-30.2	96.90
113	71	-20.1	90.06	145	91	-25.5	94.65	177	B1	-30.4	96.95
114	72	-20.3	90.26	146	92	-25.7	94.75	178	B2	-30.5	97.00
115	73	-20.5	90.45	147	93	-25.8	94.85	179	B3	-30.7	97.05
116	74	-20.6	90.65	148	94	-26	94.95	180	B4	-30.8	97.09
117	75	-20.8	90.84	149	95	-26.2	95.04	181	B5	-30.9	97.14
118	76	-21	91.04	150	96	-26.3	95.14	182	B6	-31.1	97.19
119	77	-21.2	91.24	151	97	-26.5	95.24	183	B7	-31.3	97.24
120	78	-21.4	91.43	152	98	-26.7	95.34	184	B8	-31.4	97.29
121	79	-21.6	91.63	153	99	-26.9	95.43	185	B9	-31.6	97.34
122	7A	-21.8	91.82	154	9A	-27.1	95.53	186	BA	-31.7	97.39
123	7B	-22	92.02	155	9B	-27.3	95.63	187	BB	-31.9	97.44
124	7C	-22.2	92.21	156	9C	-27.5	95.73	188	BC	-32.1	97.49
125	7D	-22.5	92.41	157	9D	-27.7	95.83	189	BD	-32.2	97.53
126	7E	-22.7	92.60	158	9E	-27.9	95.92	190	BE	-32.4	97.58
127	7F	-22.9	92.80	159	9F	-28.1	96.02	191	BF	-32.6	97.63

Continued

Table Global Dimming in Logarithmic Mode vs. register 04h data

Continue

# of steps	Hex code	Dimming, dB	Dimming, %	# of steps	Hex code	Dimming, dB	Dimming, %
192	C0	-32.8	97.68	224	E0	-42.5	99.24
193	C1	-32.9	97.73	225	E1	-42.8	99.27
194	C2	-33.1	97.78	226	E2	-43.1	99.29
195	C3	-33.3	97.83	227	E3	-43.4	99.32
196	C4	-33.5	97.88	228	E4	-43.7	99.34
197	C5	-33.7	97.92	229	E5	-44	99.37
198	C6	-33.9	97.97	230	E6	-44.4	99.39
199	C7	-34.1	98.02	231	E7	-44.7	99.41
200	C8	-34.4	98.07	232	E8	-45.1	99.44
201	C9	-34.6	98.12	233	E9	-45.5	99.46
202	CA	-34.8	98.17	234	EA	-45.9	99.49
203	CB	-35	98.22	235	EB	-46.3	99.51
204	CC	-35.3	98.27	236	EC	-46.7	99.54
205	CD	-35.5	98.32	237	ED	-47.2	99.56
206	CE	-35.8	98.36	238	EE	-47.7	99.58
207	CF	-36.1	98.41	239	EF	-48.2	99.61
208	D0	-36.3	98.46	240	F0	-48.8	99.63
209	D1	-36.6	98.51	241	F1	-49.4	99.66
210	D2	-36.9	98.56	242	F2	-50	99.68
211	D3	-37.2	98.61	243	F3	-50.7	99.71
212	D4	-37.5	98.66	244	F4	-51.5	99.73
213	D5	-37.8	98.71	245	F5	-52.3	99.76
214	D6	-38.2	98.75	246	F6	-53.2	99.78
215	D7	-38.5	98.80	247	F7	-54.3	99.80
216	D8	-38.9	98.85	248	F8	-55.4	99.83
217	D9	-39.2	98.90	249	F9	-56.7	99.85
218	DA	-39.6	98.95	250	FA	-58.3	99.88
219	DB	-40.1	99.00	251	FB	-60.3	99.90
220	DC	-40.5	99.05	252	FC	-62.8	99.93
221	DD	-40.9	99.10	253	FD	-66.3	99.95
222	DE	-41.4	99.15	254	FE	-72.3	99.98
223	DF	-41.9	99.19	255	FF		100

---

## Warranty and Use

*IXYS CORP. MAKES NO WARRANTY, REPRESENTATION OR GUARANTEE, EXPRESS OR IMPLIED, REGARDING THE SUITABILITY OF ITS PRODUCTS FOR ANY PARTICULAR PURPOSE, NOR THAT THE USE OF ITS PRODUCTS WILL NOT INFRINGE ITS INTELLECTUAL PROPERTY RIGHTS OR THE RIGHTS OF THIRD PARTIES WITH RESPECT TO ANY PARTICULAR USE OR APPLICATION AND SPECIFICALLY DISCLAIMS ANY AND ALL LIABILITY ARISING OUT OF ANY SUCH USE OR APPLICATION, INCLUDING BUT NOT LIMITED TO, CONSEQUENTIAL OR INCIDENTAL DAMAGES.*

IXYS Corp. products are not designed, intended, or authorized for use as components in systems intended for surgical implant into the body, or other applications intended to support or sustain life, or for any other application in which the failure of the IXYS Corp. product could create a situation where personal injury or death may occur.

IXYS Corp. reserves the right to make changes to or discontinue any product or service described herein without notice. Products with data sheets labeled "Advance Information" or "Preliminary" and other products described herein may not be in production or offered for sale.

IXYS Corp. advises customers to obtain the current version of the relevant product information before placing orders. Circuit diagrams illustrate typical semiconductor applications and may not be complete.

---



IXYS Corp.  
1590 Buckeye Dr.,  
Milpitas, CA 95035-7418  
Phone: 408.457.9000  
Fax: 408.496.0222  
<http://www.ixys.com>

Document No: 8160\_DS  
Revision: N1.0  
Issue date: 10/23/2009