

POWER MANAGEMENT

Features

- Flash and spotlight — two selectable modes
- Flash mode — up to 700mA output
- Flash mode — 500mA max output (over rated voltage, temperature, and load conditions)
- Flash mode safety timer shut-off — 1 second
- Spotlight mode set to 40% of flash current
- Spotlight mode — up to 280mA output
- Spotlight mode — 1x mode (under most conditions) for best efficiency
- Input range — 3.0V to 5.25V
- External flash control pin for synchronization to a camera module or graphics controller
- Short-circuit, over-voltage, and over-temperature protection
- Soft-start functionality
- Separate flash and spotlight control inputs for maximum versatility
- Ultra-thin package MLPD-UT-10 — 3mm x 3mm x 0.6mm

Applications

- Mobile camera phones
- Digital cameras
- PDAs with built-in cameras

Description

The SC618 is a high-current charge pump designed specifically for use with white LEDs used in camera flash applications. Only two small bucket capacitors are required to develop the output drive, providing a low EMI solution compared to inductive boost regulators.

The SC618 has two modes of operation: flash mode and spotlight mode. In flash mode, the SC618 is capable of delivering 500mA of regulated current for a duration of 500ms or up to 700mA for a reduced duration. A safety timer is also included to ensure the LED cannot be left on indefinitely and overheat. In spotlight mode the SC618 outputs 40% of the flash mode current and can remain enabled continuously.

An external resistor is connected in series with the LED to set the current. In flash mode, this resistor can dissipate up to 175mW, reducing the power dissipation requirement of the SC618. The flash input overrides the control input to make sure the flash function is activated.

The SC618 ultra-thin package provides both a low profile and high thermal efficiency.

Typical Application Circuit

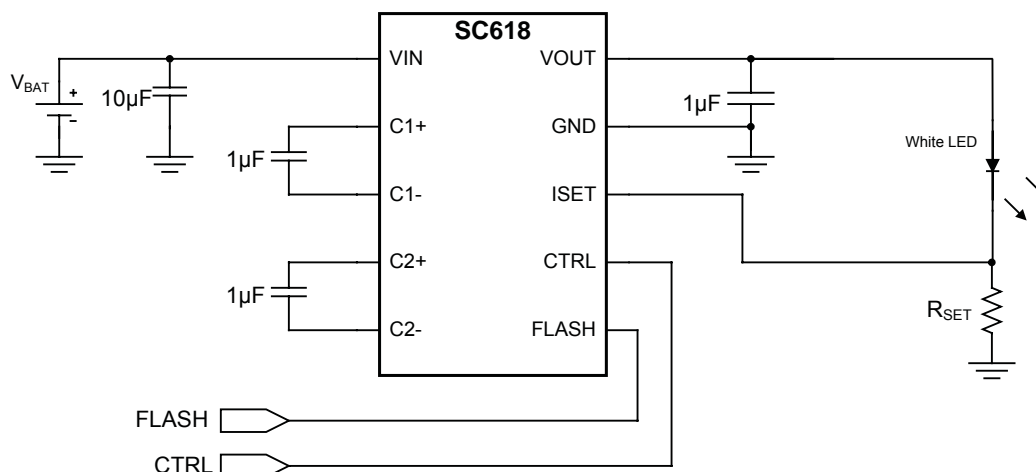



Pin Configuration

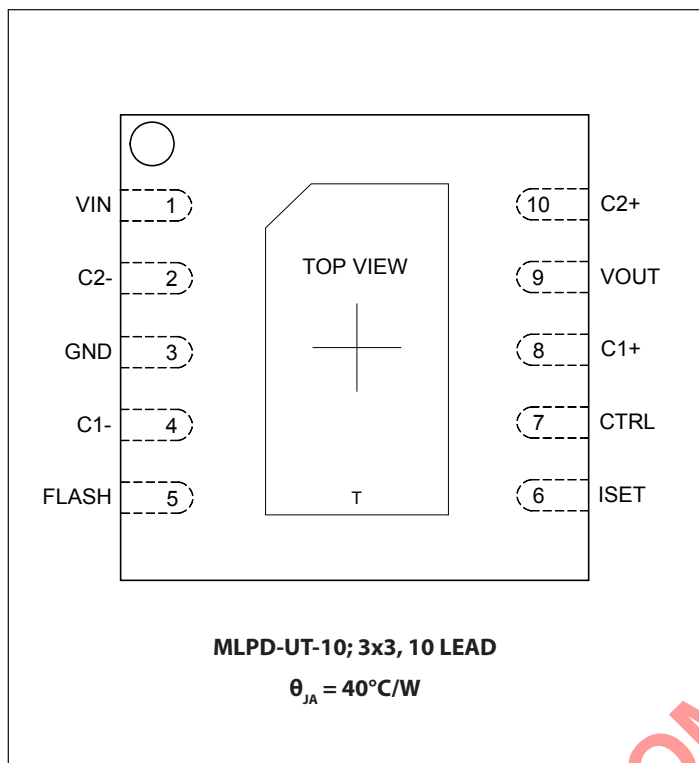

Ordering Information

Device	Package
SC618ULTRT ⁽¹⁾⁽²⁾	MLPD-UT-10 3x3
SC618EVB	Evaluation Board

Notes:

- (1) Available in tape and reel only. A reel contains 3,000 devices.
- (2) Lead-free package only. Device is WEEE and RoHS compliant.

Marking Information

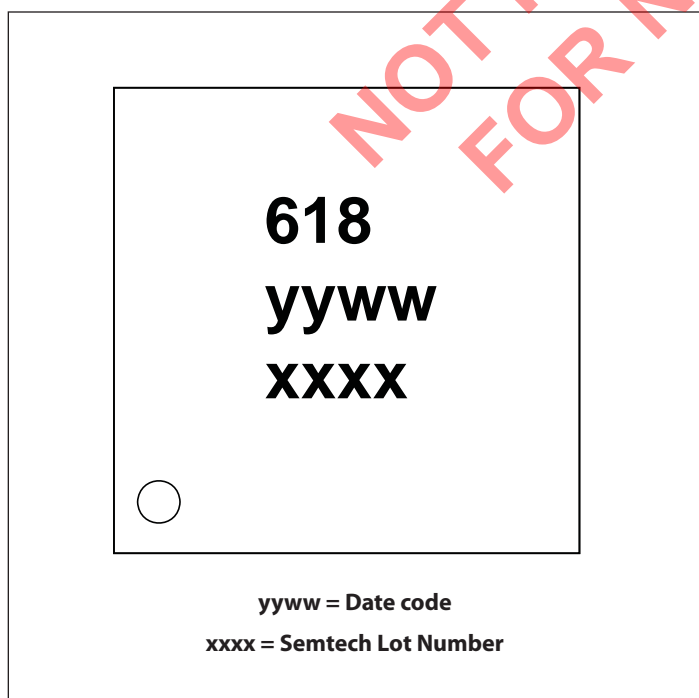

NOT RECOMMENDED FOR NEW DESIGN



Absolute Maximum Ratings

V _{IN} (V)	-0.3 to +6.5
V _{OUT} (V)	-0.3 to +6.5
C1+, C2+ (V)	-0.3 to (V _{OUT} + 0.3)
Pin Voltage - All Other Pins (V)	-0.3 to (V _{IN} + 0.3)
Circuit Duration	Continuous
ESD Protection Level ⁽¹⁾ (kV)	2

Recommended Operating Conditions

Ambient Temperature Range (°C)..... -40 to +85

Thermal Information

Thermal Resistance, Junction to Ambient⁽²⁾ (°C/W) 40

Junction Temperature Range (°C)..... -40 to +150

Storage Temperature Range (°C)..... -60 to +150

Peak IR Reflow Temperature (10s to 30s) (°C) +260

Exceeding the above specifications may result in permanent damage to the device or device malfunction. Operation outside of the parameters specified in the Electrical Characteristics section is not recommended.

NOTES:

(1) Tested according to JEDEC standard JESD22-A114-B.

(2) Calculated from package in still air, mounted to 3" x 4.5", 4 layer FR4 PCB with thermal vias under the exposed pad per JESD51 standards.

Electrical Characteristics

Unless otherwise specified: T_A = 25°C for TYP, -40°C to +60°C for MIN and MAX; C_{BUCKET} = C_{OUT} = 1.0µF (ESR < 0.1Ω); C_{IN} = 10.0µF; V_{IN} = 3.0V to 5.25V; V_{OUT} = 2.8V to 4.25V; R_{SET} = 0.5Ω (0.1%).

Parameter	Symbol	Conditions	Min	Typ	Max	Units
Output Current	I _{OUT}	FLASH high, R _{SET} = 0.357Ω 3.7V < V _{IN} < 4.2V, V _{OUT} = 3.7V ⁽¹⁾		700		mA
		FLASH high, R _{SET} = 0.5Ω 3.3V < V _{IN} < 4.2V 2.8V < V _{OUT} < 4.25V	460	500	540	
		FLASH low, CTRL high, R _{SET} = 0.357Ω 3.7V < V _{IN} < 4.2V, V _{OUT} = 3.4V ⁽¹⁾		280		
		FLASH low, CTRL high, R _{SET} = 0.5Ω 3.0V < V _{IN} < 4.5V 2.8V < V _{OUT} < 4.5V	170	200	230	
ISET Reference Voltage	V _{ISET}	FLASH high, R _{SET} = 0.5Ω 3.3V < V _{IN} < 4.2V 2.8V < V _{OUT} < 4.25V	230	250	270	mV
		FLASH low, CTRL high, R _{SET} = 0.5Ω 3.0V < V _{IN} < 4.5V 2.8V < V _{OUT} < 4.5V	85	100	115	
Quiescent Current	I _Q	FLASH high		3.4	5.0	mA
		FLASH low, CTRL high		2.0	4.5	mA
		FLASH low, CTRL low		0.1	2.0	µA



Electrical Characteristics (continued)

Parameter	Symbol	Conditions	Min	Typ	Max	Units
Flash Mode Pulse Duration ⁽²⁾	t_{FLASH}	$3.3V < V_{IN} < 4.2V$ $I_{OUT} = 500mA, V_{OUT} > 2.8V$			500	ms
Flash Mode Start-Up Time ⁽²⁾	t_{F-SU}	$t = 0$ when FLASH goes high to $I_{OUT} = 90%$ of final value			1	ms
Flash Mode Safety Timer ⁽²⁾	t_{SAFE}	FLASH high	0.90		1.25	s
Spotlight Mode Start-Up Time ^(2,3)	t_{S-SU}	$V_{IN} = 4.2V, V_{OUT} = 3.2V; t = 0$ when CTRL goes high to $I_{OUT} = 90%$ of final value			1	ms
Oscillator Frequency	f_{OSC}	Device enabled		250		kHz
Oscillator Frequency Accuracy	Δf_{OSC}		-15		15	%
Short-Circuit Output Current Limit	I_{SC}	Steady State with VOUT shorted to GND			600	mA
Input Current Limit	I_{LIMIT}	2x mode, $3.3V < V_{IN} < 4.2V$			2.1	A
		2x mode, $V_{IN} = 3.7V, V_{OUT} = 3.7V, T_A = 25^\circ C$	1.38	1.53		
Over-Temperature Protection ⁽²⁾	T_{OT}	Rising threshold	150			$^\circ C$
	T_{OT-HYS}	Hysteresis	10			
Logic Input High Threshold	V_{IH}	FLASH, CTRL	1.5			V
Logic Input Low Threshold	V_{IL}	FLASH, CTRL			0.4	V
Logic Input High Current	I_{IH}	FLASH	1	20	35	μA
		CTRL	2	40	70	
Logic Input Low Current	I_{IL}	FLASH, CTRL		0.1	2.0	μA
ISET Ripple Voltage	$V_{ISET(P-P)}$	Spotlight mode — $I_{OUT} = 200mA$		25		mV
		FLASH mode — $I_{OUT} = 500mA$		100		

Notes:

- 1) V_{OUT} required by the typical LED at this current.
- 2) Guaranteed by design - not tested in production.
- 3) If conditions force 2x mode operation, this start-up time will increase by approximately 32ms due to the timer that is enabled to ensure 2x mode is needed.



Typical Characteristics

Flash Current at 10ms, $R_{ISET} = 500m\Omega$, $V_{OUT} = 3.75V$

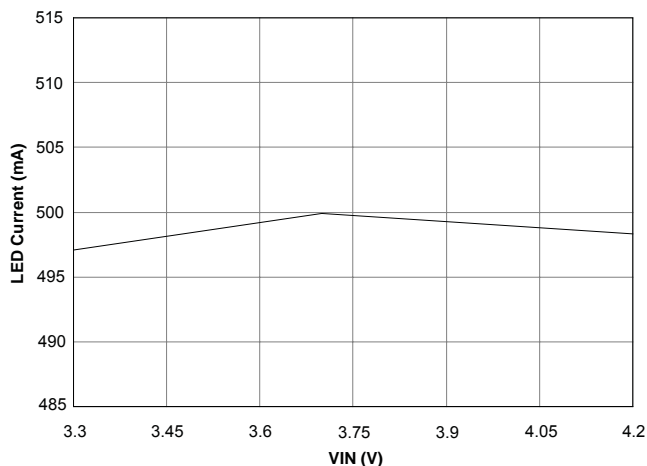

Flash Current at 100ms, $R_{ISET} = 500m\Omega$, $V_{OUT} = 3.68V$

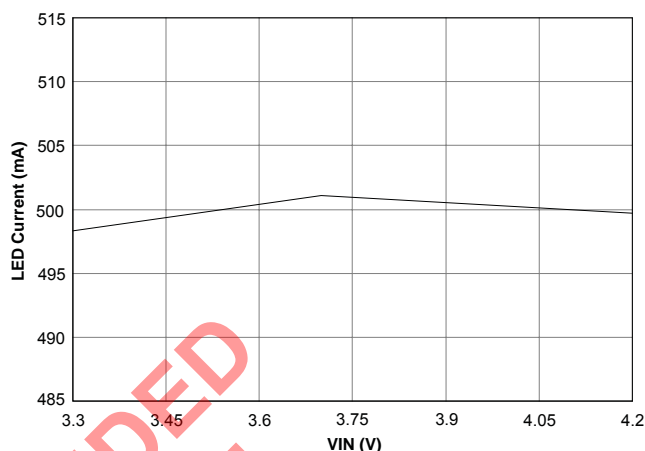

Flash Current at 500ms, $R_{ISET} = 500m\Omega$, $V_{OUT} = 3.58V$

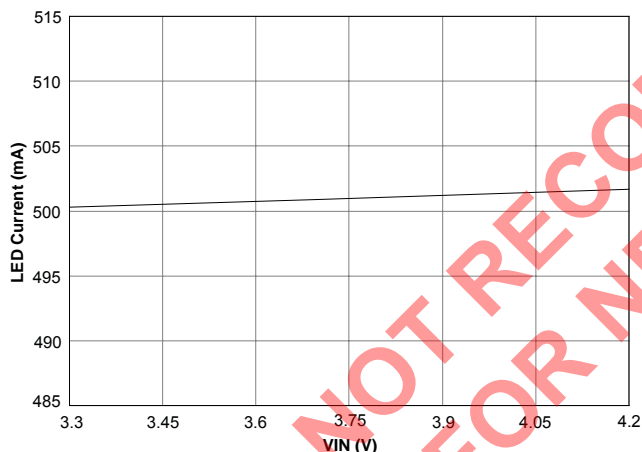

Spotlight Current, $R_{ISET} = 500m\Omega$, $V_{OUT} = 3.16V$

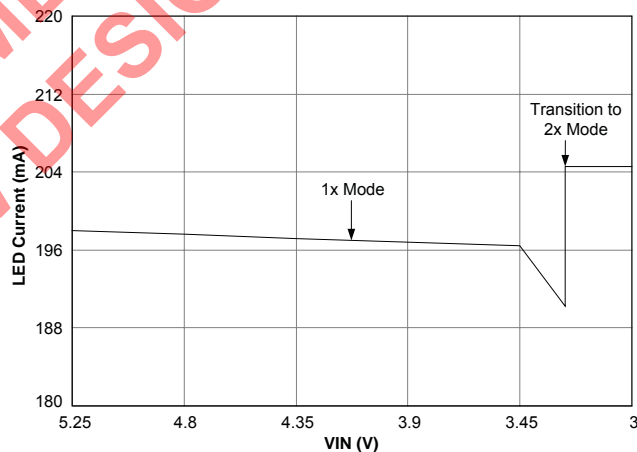

Flash Duration, $R_{ISET} = 350m\Omega$, $V_{OUT} = 3.86V$ (start), 3.61V (LED Heated 500ms)

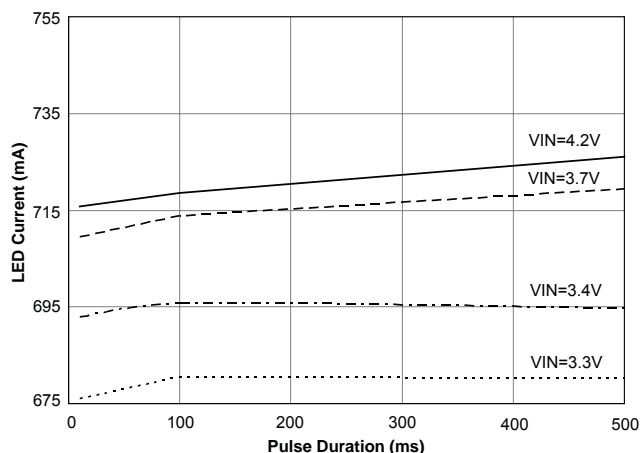

Flash Duration, $R_{ISET} = 500m\Omega$, $V_{OUT} = 3.75V$ (start), 3.58V (LED Heated 500ms)

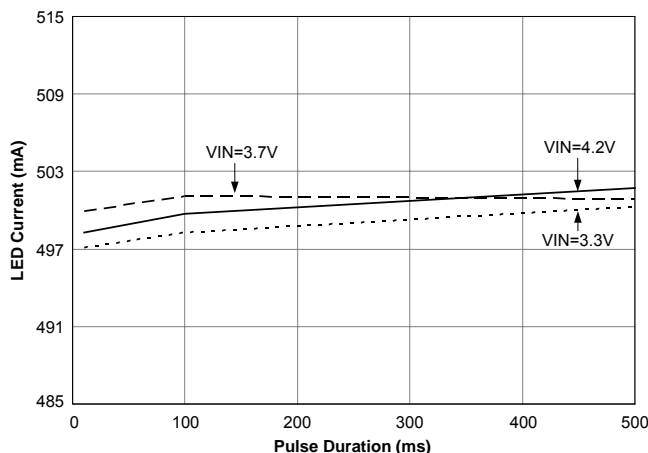



Typical Characteristics (continued)

Flash Mode Ripple, $R_{ISET} = 500m\Omega$

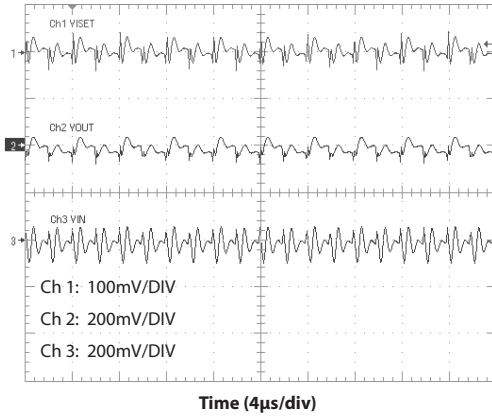

Start-Up Flash Mode, 500mA

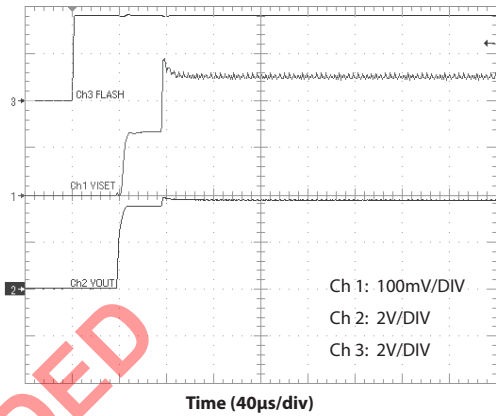

Safety Timer Shut-Off

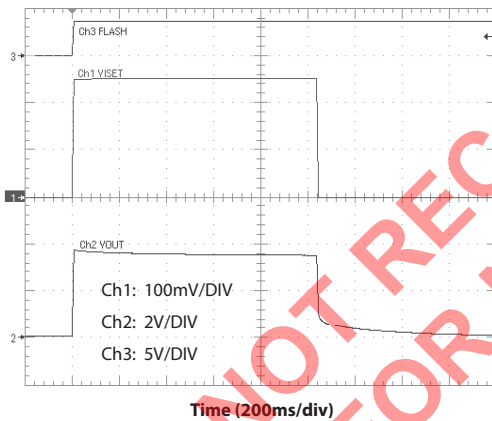

Spotlight 1x Mode Ripple, $R_{ISET} = 500m\Omega$

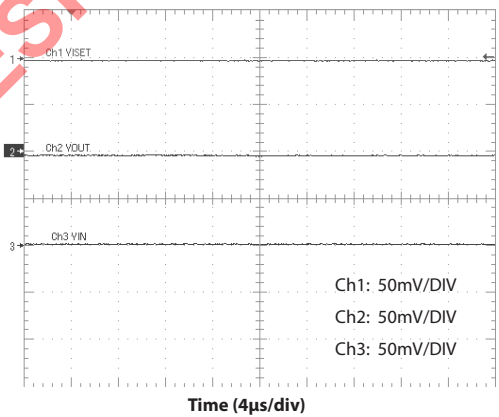

Spotlight 2x Mode Ripple, $R_{ISET} = 500m\Omega$

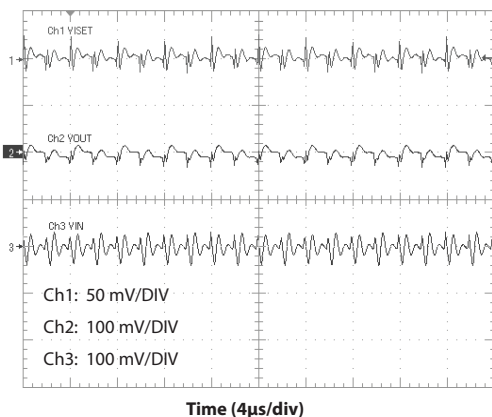

Short Circuit Current Limiting, $V_{IN} = 5.25V, V_{OUT} = 0V$

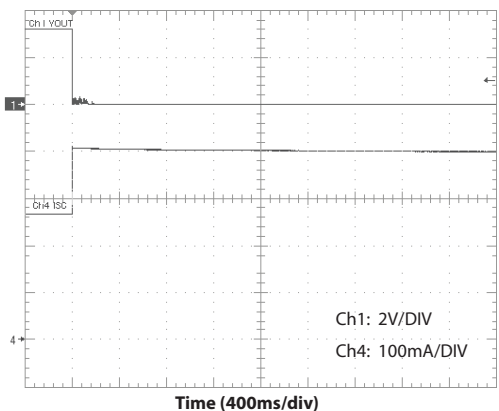



Pin Descriptions

Pin#	Pin Name	Pin Function
1	VIN	Input voltage
2	C2-	Negative terminal of bucket capacitor 2
3	GND	Ground— connect to ground plane using multiple vias
4	C1-	Negative terminal of bucket capacitor 1
5	FLASH	Flash mode enable pin— puts the device in active flash mode when high and also overrides CTRL.
6	ISET	Current-setting reference pin — connect to the LED cathode and the current setting resistor.
7	CTRL	Control input bit — used to enable and set the output current in spotlight mode when high.
8	C1+	Positive terminal of bucket capacitor 1
9	VOUT	Output pin — connect to the LED anode
10	C2+	Positive terminal of bucket capacitor 2
T	Thermal Pad	Pad for heat sinking purposes — not connected internally. Connect to ground plane using multiple vias.

NOT RECOMMENDED
FOR NEW DESIGN



Block Diagram

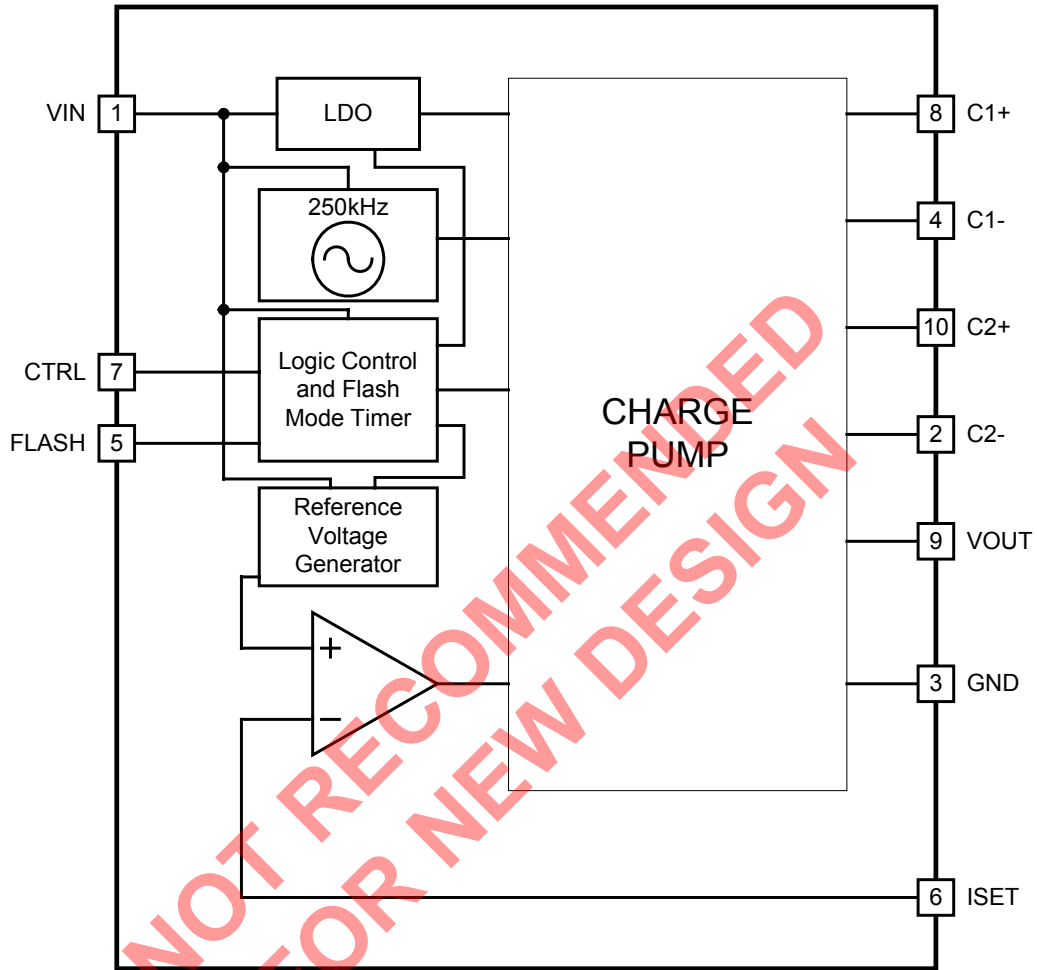



Applications Information

General Operation

The SC618 is a powerful dual-mode charge pump designed to drive a high-intensity white LED. A constant current spotlight mode or a pulsed current with higher intensity is used for camera flash. The device operates in 2x mode while operating in flash mode. In spotlight mode it can operate in either 2x or 1x mode depending on the load current, load voltage, and input voltage levels.

In flash mode the SC618 output can drive 500mA at 4.25V into an LED for a minimum duration of 500ms under all temperature and input conditions. The FLASH pin is used to trigger this mode (active high). In spotlight mode the SC618 regulates the output current to 40% of the flash mode current setting, when the CTRL pin is pulled high and the FLASH pin is low. Flash mode has priority over spotlight mode, i.e., the FLASH pin triggers flash mode regardless of the state of the CTRL pin.

Output current is regulated by attaching the ISET pin to the cathode(s) of the LED package and a low resistance sense resistor (typically 0.5Ω). The ISET pin monitors the voltage at the cathode and signals the charge pump to increase or decrease the output current until the ISET voltage reaches the programmed setting. The resistor value is chosen to set the current through the LED based on this reference voltage. The resistor can be chosen to set either the flash mode current or spotlight mode current, but it should not be less than 0.35Ω due to output current limitations of the device.

Flash Mode

Flash mode is enabled whenever the FLASH pin is pulled high and remains active until the FLASH pin is released. This mode has higher priority than spotlight mode, so the state of the CTRL pin is overridden whenever the FLASH pin is activated. While in flash mode the reference voltage on the ISET pin is set to 250mV. The duration of the pulse is limited by the amount of power that can be dissipated in the SC618 before it exceeds the maximum operating temperature. If an output current less than the rated 500mA is desired, the duration of the pulse can increase proportionally.

Extending flash mode beyond the 500ms pulse limit could adversely affect the long term reliability of the SC618. Flash duration must be derated at higher currents. For

example, 700mA derates to a maximum of 350ms. In flash mode, $I_{OUT} = 250\text{mV}/R_{ISET}$. Figure 1 shows maximum flash mode current for extended duration times.

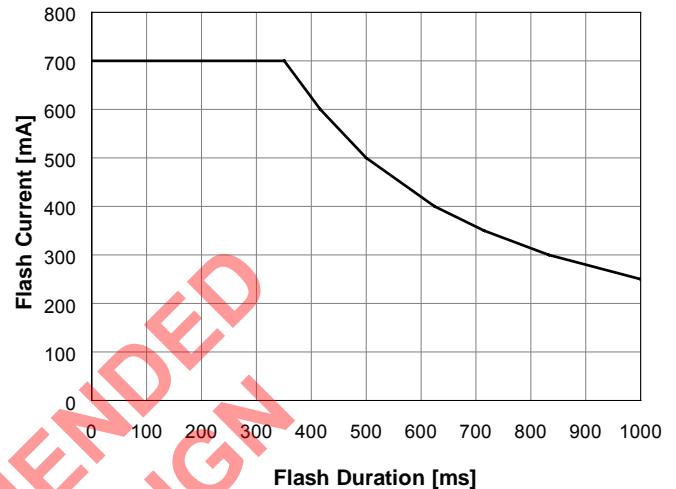

Figure 1 — Maximum Flash Duration

Flash Mode Safety Timer

The SC618 provides a time-out protection function when in flash mode. The output is disabled if the FLASH pin is held high for longer than 1 second to protect the LED. Once this time-out has occurred, the output will stay disabled until the FLASH pin has been pulled low and then re-enabled.

Spotlight Mode

Spotlight mode is enabled by setting the CTRL pin high and keeping the FLASH pin low. When in spotlight mode, the SC618 can maintain a constant current indefinitely to drive an LED or bank of LEDs. The ISET reference voltage is set to 100mV so that the output current is maintained at 200mA when a 0.5Ω resistor is used. Spotlight current is always 40% of flash current for any given value of R_{ISET} . In spotlight mode, $I_{OUT} = 100\text{mV}/R_{ISET}$.

To maximize power efficiency, the SC618 has been designed to operate in 1x mode when conditions do not require the charge pump to be active. When first enabled the SC618 attempts to regulate the voltage on the ISET pin in 1x mode. If the voltage on the ISET pin cannot be maintained and this condition persists for longer than 32ms, then the charge pump will change to 2x mode operation. In a typical application, the SC618 will operate in 1x mode until the supply voltage decreases sufficiently



Applications Information (continued)

that the voltage on the ISET pin can no longer be maintained. After a 32ms delay (included to prevent false transitions) the charge pump will convert to 2x mode. After the charge pump switches from 1x mode to 2x mode, the device remains in 2x mode until the part is turned off. If the part is re-enabled in spotlight mode, it will begin operation in 1x mode and determine the appropriate mode of operation as previously described.

Protection Circuitry

The SC618 provides several protection features to safeguard the device from catastrophic failures. These features include:

- Input Over-Voltage Protection (IOVP)
- Output Over-Voltage Protection (OVP)
- Over-Temperature Protection (OTP)
- Over-Current Protection (OCP)
- Short-Circuit Current Protection (SCCP)

Input Over-Voltage Protection

IOVP is included to prevent operation at high input voltages that could damage the device. The IOVP circuit senses the input voltage and determines when the supply exceeds 6V. Hysteresis is included in this circuit to avoid chattering between states. When the voltage rises above this threshold, the device is disabled until the input voltage drops to a level within the specified range.

Output Over-Voltage Protection

Output OVP prevents the SC618 from generating an output voltage that could damage other devices connected to it such as load LEDs and bypass capacitors. When the output voltage exceeds 5.5V, the OVP circuit disables the charge pump until the voltage decreases to a level within the acceptable range. This circuit allows the device to drive LEDs with high forward voltages at a reduced level without exceeding the output voltage limits specified for the device.

Over-Temperature Protection

The OTP circuit prevents the device from overheating and experiencing a catastrophic failure. When the junction temperature exceeds 150°C the device is disabled. It remains disabled until the junction temperature drops below this threshold. Hysteresis is included to prevent toggling between modes.

Over-Current Protection

When the SC618 is in 2x mode, the input current will be approximately double the required output. When the steady-state load requires the maximum current available in 2x mode, the OCP circuit prevents the device from overheating from excessive power dissipation. This feature protects the device when in 1x mode. The current limit is set lower in the 1x mode due to lower current requirements.

Short-Circuit Current Protection

SSCP is provided to limit the current that can be sourced when the output is shorted to ground. When a short circuit forces V_{OUT} to drop below 2V, the SCCP detects the condition and limits the output current.

Resistor Selection

The ISET resistor selection is critical in generating the correct current. The value can be chosen to set the spotlight mode current or the flash mode current, and the two current settings are dependent on the same resistor. It is recommended that the resistor be selected to match the desired LED current for flash mode. This allows the designer to set the SC618's maximum current and select the resistor package size necessary for the power dissipation required in flash mode. The typical application uses a 0.5Ω resistor to set a flash mode current of 500mA and spotlight mode current of 200mA. A high precision resistor should be used to ensure the specified accuracy for LED current.

To avoid malfunction of the charge pump, it is recommended that the resistance seen at the ISET pin remain constant while the device is active (flash or spotlight mode). Changing the resistance value or the load current while the device is active could cause instability.

Capacitor Selection

The SC618 is designed to use low-ESR ceramic capacitors for the input and output bypass capacitors as well as the charge pump bucket capacitors. Ideal performance is achieved when C1 is exactly equal to C2. It is recommended that X5R or X7R ceramic capacitors be used for best performance.

Applications Information (continued)

PCB Layout Considerations

The following layout is suggested for a two-layer design. The capacitors C1 and C2 are the bucket capacitors and each conducts the full load current of up to 500mA pulsed for one half clock cycle. C3 is the output decoupling capacitor placed near the VOUT pin. C4 is the input decoupling capacitor placed near the VIN pin. Multiple vias should be used whenever it is necessary to change layers on nets connecting to pins VIN, VOUT, GND, C1-, C1+, C2-, and C2+.

The load current return path is from the ISET sense point through the resistor and back to the ground pins. Resistance in this path adds to the total resistance and has the effect of reducing the LED current by about 4% per 10mV of DC drop across the return copper trace in flash mode. For this reason, it is crucial to have a low resistance return path. Place and ground the resistor as close as possible to the ground pin of the SC618. The trace from the ISET pin has virtually no current. The ISET trace should make contact at the pad of the power sense resistor to minimize the effect of voltage drop between the LED cathode and the resistor.

Resistor R1 is routed with a very low resistance connection between R1 and GND pin 3. The sense trace between Pin 6 and R1 is routed around the ground vias, allowing the shortest ground return path possible. The sense trace is connected to R1 at the positive terminal pad for the most accurate output possible. The bottom copper layer is mostly a ground plane with no obstructions between the ground vias. The smaller rectangle to the left connects the input power to VIN pin 1 and input capacitor C4. The two traces at the lower left are for logic inputs FLASH and CTRL. The trace to the right is the ISET pin sense trace. The sense trace is routed out of the path of the returning ground current.

Thermal Resistance Considerations

The SC618 package is thermally efficient when the circuit board layout connects the thermal pad through multiple vias to the ground plane. The thermal resistance is rated at 40°C/W, and this rating is dependent on the connection between the thermal pad and the ground plane. The layout should keep the junction temperature below the OTP limit while operating the SC618 within the specified electrical conditions for I_{OUT} and V_{ISET} . A poor layout may allow the junction temperature to reach the OTP limit

while in flash or spotlight mode. It is critical to maintain adequate ground plane around the device to maximize heat transfer and avoid over-temperature shutdown.

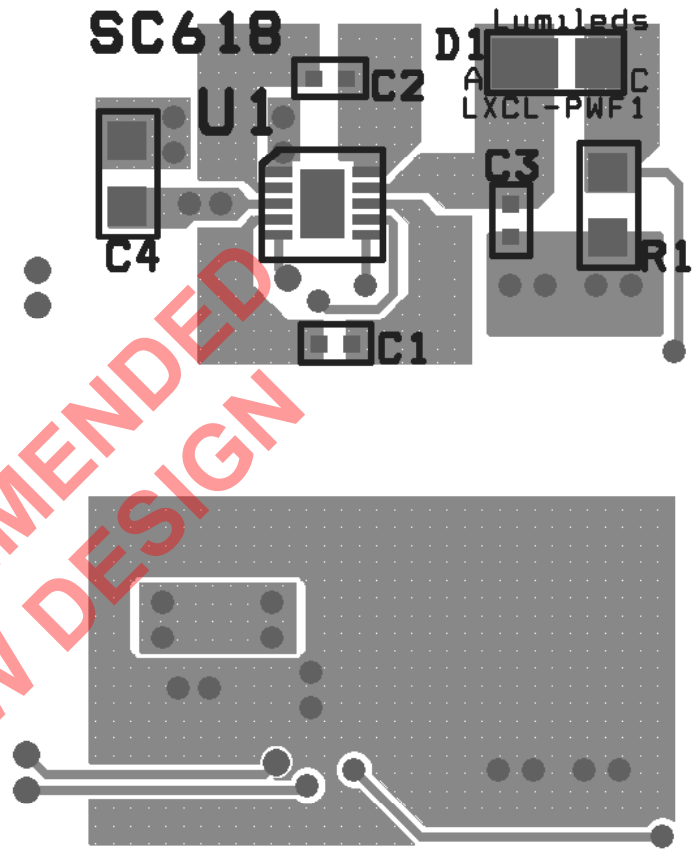



Outline Drawing — MLPD-UT-10

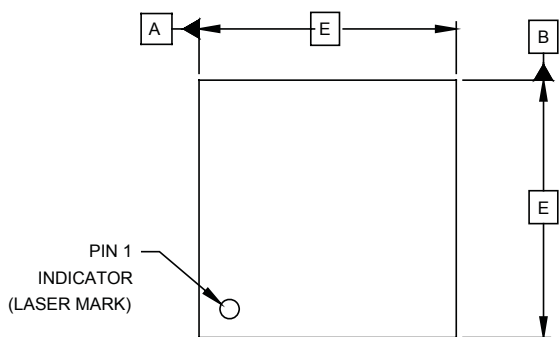

DIM	DIMENSIONS					
	INCHES			MILLIMETERS		
	MIN	NOM	MAX	MIN	NOM	MAX
A	.018	-	.024	0.45	-	0.60
A1	.000	-	.002	0.00	-	0.05
A2	(.006)			(0.1524)		
b	.007	.009	.011	0.18	0.23	0.30
C	.074	.079	.083	1.87	2.02	2.12
D	.042	.048	.052	1.06	1.21	1.31
E	.114	.118	.122	2.90	3.00	3.10
e	.020 BSC			0.50 BSC		
L	.012	.016	.020	0.30	0.40	0.50
N	10			10		
aaa	.003			0.08		
bbb	.004			0.10		

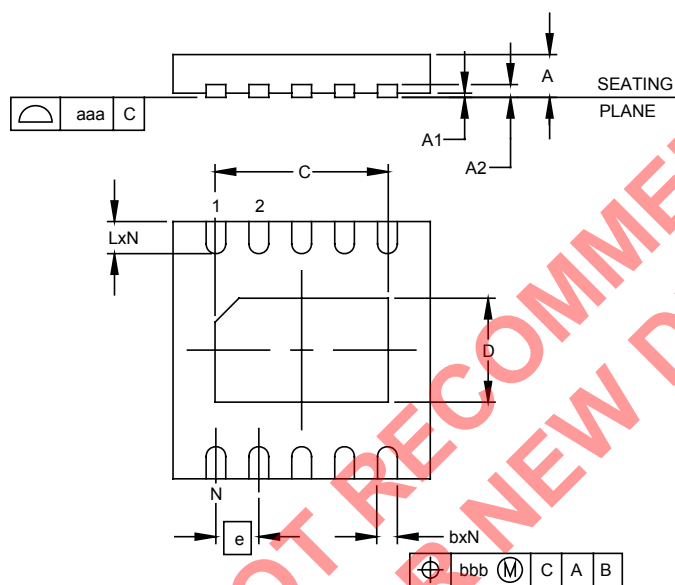

NOTES:

1. CONTROLLING DIMENSIONS ARE IN MILLIMETERS (ANGLES IN DEGREES).
2. COPLANARITY APPLIES TO THE EXPOSED PAD AS WELL AS TERMINALS.



Land Pattern — MLPD-UT-10

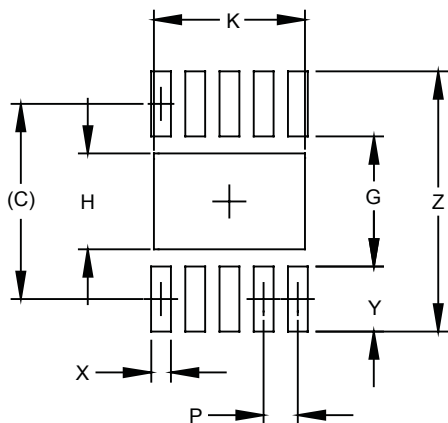

DIMENSIONS		
DIM	INCHES	MILLIMETERS
C	(.112)	(2.85)
G	.075	1.90
H	.055	1.40
K	.087	2.20
P	.020	0.50
X	.012	0.30
Y	.037	0.95
Z	.150	3.80

NOTES:

1. THIS LAND PATTERN IS FOR REFERENCE PURPOSES ONLY. CONSULT YOUR MANUFACTURING GROUP TO ENSURE YOUR COMPANY'S MANUFACTURING GUIDELINES ARE MET.
2. THERMAL VIAS IN THE LAND PATTERN OF THE EXPOSED PAD SHALL BE CONNECTED TO A SYSTEM GROUND PLANE. FAILURE TO DO SO MAY COMPROMISE THE THERMAL AND/OR FUNCTIONAL PERFORMANCE OF THE DEVICE.

NOT RECOMMENDED FOR NEW DESIGN

Contact Information

Semtech Corporation
 Power Management Products Division
 200 Flynn Road, Camarillo, CA 93012
 Phone: (805) 498-2111 Fax: (805) 498-3804

www.semtech.com