

LM2759

1A Switched Capacitor Flash LED Driver with I²C Compatible Interface

General Description

LM2759 is an integrated low-noise, high-current switched capacitor DC/DC converter with a regulated current source. The device requires only four small ceramic capacitors making the total solution area less than 22 mm² and the height less than 1 mm. The LM2759 is capable of driving loads up to 1A from a single-cell Li-Ion battery. Maximum efficiency is achieved over the input voltage range by actively selecting the proper gain based on the LED forward voltage and current requirements.

The LED current can be programmed up to 1A via an I²C-compatible interface, along with eight selectable Flash Time-Out durations. One high-current Flash LED can be driven either in a high-power Flash mode or a low-power Torch mode. The Strobe pin allows the flash to be toggled via a Flash enable signal from a camera module. The TX input pin limits the Flash LED current to the Torch current level during a RF PA pulse, to reduce high loads on the battery. Internal soft-start circuitry limits the amount of inrush current during start-up.

LM2759 is offered in a small 12-pin thermally enhanced LLP package.

Features

- Up to 1A Output Current
- Solution Area < 22 mm²
- No Inductor Required
- 90% Peak Efficiency
- Adaptive 1x, 1.5x and 2x Gains for Maximum Efficiency
- Load Disconnect in Shutdown
- Accurate Input Current Control During Gain Transitions
- Flash Time-Out
- TX Input Pin Ensures Synchronization with RF Power Amplifier Pulse
- Torch, Flash, and Indicator Modes
- External Flash Enable via Strobe Input Pin
- Strobe Input Disable via I²C
- Programmable Flash Pulse Duration, and Torch and Flash Currents via I²C-Compatible Interface
- 1MHz Constant Frequency Operation
- Low Profile 12-Pin LLP (3mm x 3mm x 0.8mm)

Applications

- Camera Flash in Cellular Phones

Typical Application Circuit

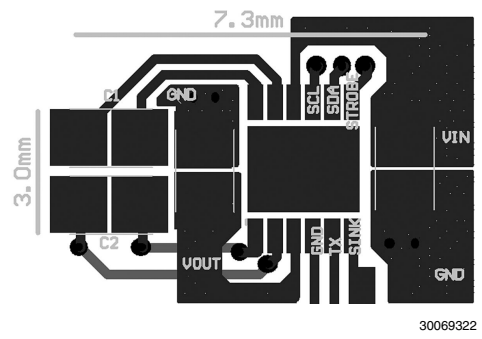
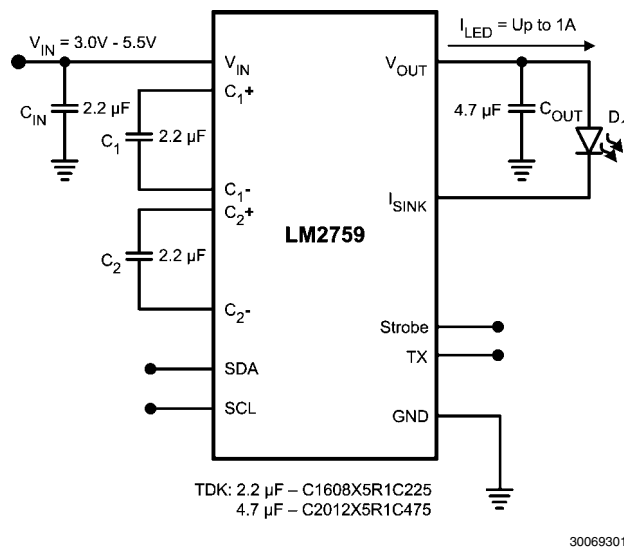

LM2759 1A Switched Capacitor Flash LED Driver with I²C Compatible Interface

Connection Diagram

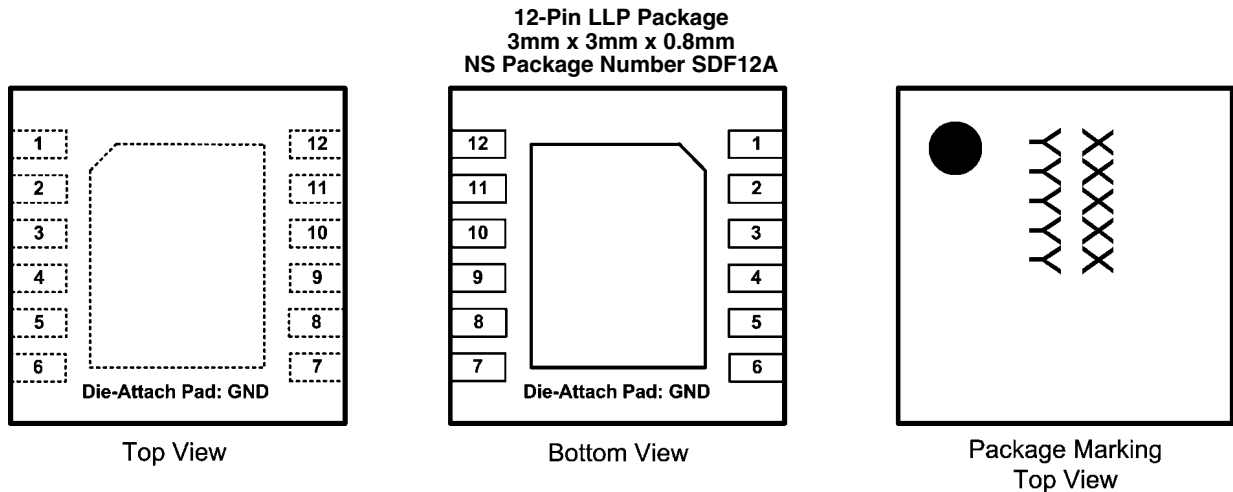

30069302

Note 1: The actual physical placement of the package marking will vary from part to part. The package marking placeholder "XXXXX" is a code for the die traceability. "YYYYY" identifies the device (part number, voltage option, etc.). See the Order Information table below for the device ID codes.

Pin Descriptions

Pin	Name	Description
10	V_{IN}	Input voltage connection.
3	V_{OUT}	Charge pump regulated output.
12	C1-	Flying capacitor connections.
11	C1+	
2	C2+	
1	C2-	
4	GND	Ground connection.
6	I_{SINK}	Regulated current sink input.
8	SDA	Serial data I/O pin.
7	Strobe	Manual flash enable pin. Flash will remain on for the duration that the Strobe pin is held high or when the Flash Timeout occurs, whichever comes first.
5	TX	Transmission pulse Flash interrupt pin. High = RF PA pulse active, LED current reduced to Torch level, Low = RF PA pulse off, LED at full programmed current level.
9	SCL	Serial clock pin.

Ordering Information

Order Number	Package Description	Package Marking	Supplied as Tape and Reel (Units)
LM2759SD	No-Pullback	ZXYTT	1000 units, tape and reel
LM2759SDX	LLP-12	L2759	4500 units, tape and reel

Absolute Maximum Ratings (Note 2, Note 3)

3)

If Military/Aerospace specified devices are required, please contact the National Semiconductor Sales Office/Distributors for availability and specifications.

V_{IN} pin: Voltage to GND	-0.3V to 6.0V
Strobe, TX, SDA, SCL, I_{SINK} pins: Voltage to GND	-0.3V to ($V_{IN} + 0.3V$) w/ 6.0V max
Continuous Power Dissipation <small>(Note 4)</small>	Internally Limited
Junction Temperature (T_{J-MAX})	150°C
Storage Temperature Range	-65°C to 150°C
Maximum Lead Temp. (Soldering)	<small>(Note 5)</small>
ESD Rating <small>(Note 6)</small>	
Human Body Model	2.5KV

ESD Caution Notice

National Semiconductor recommends that all integrated circuits be handled with appropriate ESD precautions. Failure to observe proper ESD handling techniques can result in damage to the device.

Electrical Characteristics (Note 3, Note 9)

Limits in standard typeface are for $T_J = 25^\circ\text{C}$. Limits in **boldface** type apply over the full operating junction temperature range ($-30^\circ\text{C} \leq T_J \leq +125^\circ\text{C}$). Unless otherwise noted, specifications apply to the LM2759 Typical Application Circuit (pg.1) with $V_{IN} = 3.6V$, $V_{TX} = 0V$, $V_{STROBE} = 0V$, $C_{IN} = C_1 = C_2 = 2.2 \mu\text{F}$, $C_{OUT} = 4.7 \mu\text{F}$. (Note 10)

Symbol	Parameter	Conditions	Min	Typ	Max	Units
I_{LED}	LED Current Sink Accuracy	Flash Mode ADDR xB0 = 0x02	198 -10%	220	242 +10%	mA
I_{FLASH}	Max Flash Output Current	Flash Mode ADDR xB0 = 0x0F		1		A
V_{GDX}	Gain Transition Voltage Threshold on I_{SINK}	$I_{LED} = 500\text{mA}$ (V_{ISINK} falling)		350		mV
V_{OUT}	Output Voltage	1x Mode, $I_{OUT} = 0 \text{ mA}$ ($V_{IN} > V_{OUT}$) <small>(Note 12)</small>		4.7	4.9	V
		1.5x Mode, $I_{OUT} = 0 \text{ mA}$		4.7	4.9	
		2x Mode, $I_{OUT} = 0 \text{ mA}$		5.1	5.4	
R_{OUT}	x1 Mode Output Impedance	$I_{OUT} = 200\text{mA}$, $V_{IN} = 3.3V$		0.33		Ω
	1.5x Mode Output Impedance	$I_{OUT} = 500\text{mA}$, $V_{IN} = 3.3V$		1.9		
	x2 Mode Output Impedance			2.25		
F_{SW}	Switching Frequency	$2.7V \leq V_{IN} \leq 5.5V$	0.7	1	1.3	MHz
V_{IH}	Input Logic High	Pins: TX, Strobe	1.26			V
V_{IL}	Input Logic Low	Pins: TX, Strobe			0.7	V
I_Q	Quiescent Current	$I_{OUT} = 0 \text{ mA}$, 1x Mode		0.6	0.9	mA
		$I_{OUT} = 0 \text{ mA}$, 1.5x Mode		3.4	4.0	
		$I_{OUT} = 0 \text{ mA}$, 2x Mode		5.9	7.0	
I_{SD}	Shutdown Current	Device Disabled $2.7V \leq V_{IN} \leq 5.5V$		5.8	9.7	μA

Operating Ratings (Note 2, Note 3)

Input Voltage Range	2.7V to 5.5V
LED Voltage Range	2.0V to 4.0V
Junction Temperature Range (T_J)	-30°C to $+125^\circ\text{C}$
Ambient Temperature Range (T_A) <small>(Note 7)</small>	-30°C to $+85^\circ\text{C}$

Thermal Information

Junction-to-Ambient Thermal Resistance (θ_{JA}), Leadless Leadframe Package <small>(Note 8)</small>	36.7°C/W
--	----------

Limits in standard typeface are for $T_J = 25^\circ\text{C}$. Limits in **boldface** type apply over the full operating junction temperature range ($-30^\circ\text{C} \leq T_J \leq +125^\circ\text{C}$). Unless otherwise noted, specifications apply to the LM2759 Typical Application Circuit (pg.1) with $V_{IN} = 3.6\text{V}$, $V_{TX} = 0\text{V}$, $V_{STROBE} = 0\text{V}$, $C_{IN} = C_1 = C_2 = 2.2\ \mu\text{F}$, $C_{OUT} = 4.7\ \mu\text{F}$. (*Note 10*)

Symbol	Parameter	Conditions	Min	Typ	Max	Units
I²C Compatible Interface Voltage Specifications (SCL, SDA).						
V_{IL}	Input Logic Low "0"	$2.7\text{V} \leq V_{IN} \leq 5.5\text{V}$			0.72	V
V_{IH}	Input Logic High "1"	$2.7\text{V} \leq V_{IN} \leq 5.5\text{V}$	1.25			V
V_{OL}	Output Logic Low "0"	$I_{LOAD} = 3\ \text{mA}$			300	mV
I²C Compatible Interface Timing Voltage Specifications (SCL, SDA) (<i>Note 11</i>)						
t_1	SCL (Clock Period)		2.5			μs
t_2	Data in Setup Time to SCL High		100			ns
t_3	Data Out Stable After SCL Low		0			ns
t_4	SDA Low Setup Time to SCL Low (Start)		100			ns
t_5	SDA High Hold Time After SCL High (Stop)		100			ns

Note 2: Absolute Maximum Ratings indicate limits beyond which damage to the component may occur. Operating Ratings are conditions under which operation of the device is guaranteed. Operating Ratings do not imply guaranteed performance limits. For guaranteed performance limits and associated test conditions, see the Electrical Characteristics tables.

Note 3: All voltages are with respect to the potential to the GND pin.

Note 4: Internal thermal shutdown circuitry protects the device from permanent damage. Thermal shutdown engages at $T_J = 150^\circ\text{C}$ (typ.) and disengages at $T_J = 120^\circ\text{C}$ (typ.).

Note 5: For detailed soldering specifications and information, please refer to National Semiconductor Application Note AN-1187.

Note 6: The Human body model is a 100 pF capacitor discharged through a 1.5 k Ω resistor into each pin. (MIL-STD-883 3015.7)

Note 7: In applications where high power dissipation and/or poor package thermal resistance is present, the maximum ambient temperature may have to be derated. Maximum ambient temperature (T_{A-MAX}) is dependent on the maximum operation junction temperature ($T_{J-MAX-OP} = 125^\circ\text{C}$), the maximum power dissipation of the device in the application (P_{D-MAX}), and the junction-to ambient thermal resistance of the part/package in the application (θ_{JA}), as given by the following equation: $T_{A-MAX} = T_{J-MAX-OP} - (\theta_{JA} \times P_{D-MAX})$.

Note 8: Junction-to-ambient thermal resistance (θ_{JA}) is taken from a thermal modeling result, performed under the conditions and guidelines set forth in the JEDEC standard JESD51-7. The test board is a 4-layer FR-4 board measuring 102 mm x 76 mm x 1.6 mm with a 2x1 array of thermal vias. The ground plane on the board is 50 mm x 50 mm. Thickness of copper layers are 53 μm /35 μm /35 μm /53 μm (1.5oz/1oz/1oz/1.5oz). Ambient temperature in simulation is 22 $^\circ\text{C}$, still air. Power dissipation is 1W.

The value of θ_{JA} of this product in the LLP package could fall in a range as wide as 30 $^\circ\text{C}/\text{W}$ to 150 $^\circ\text{C}/\text{W}$ (if not wider), depending on PWB material, layout, and environmental conditions. In applications where high maximum power dissipation exists (high V_{IN} , high I_{OUT}), special care must be paid to thermal dissipation issues. For more information on these topics, please refer to **Application Note 1187: Leadless Leadframe Package (LLP)** and the *Power Efficiency and Power Dissipation* section of this datasheet.

Note 9: Min and Max limits are guaranteed by design, test, or statistical analysis. Typical (Typ) numbers are not guaranteed, but do represent the most likely norm. Unless otherwise specified, conditions for Typ specifications are: $V_{IN} = 3.6\text{V}$ and $T_A = 25^\circ\text{C}$.

Note 10: C_{IN} , C_{OUT} , C_1 , C_2 : Low-ESR Surface-Mount Ceramic Capacitors (MLCCs) used in setting electrical characteristics.

Note 11: SCL and SDA should be glitch-free in order for proper brightness control to be realized.

Note 12: For input voltage below the regulation target during the gain of 1x, the output voltage will typically be equal to the input voltage.

Block Diagram

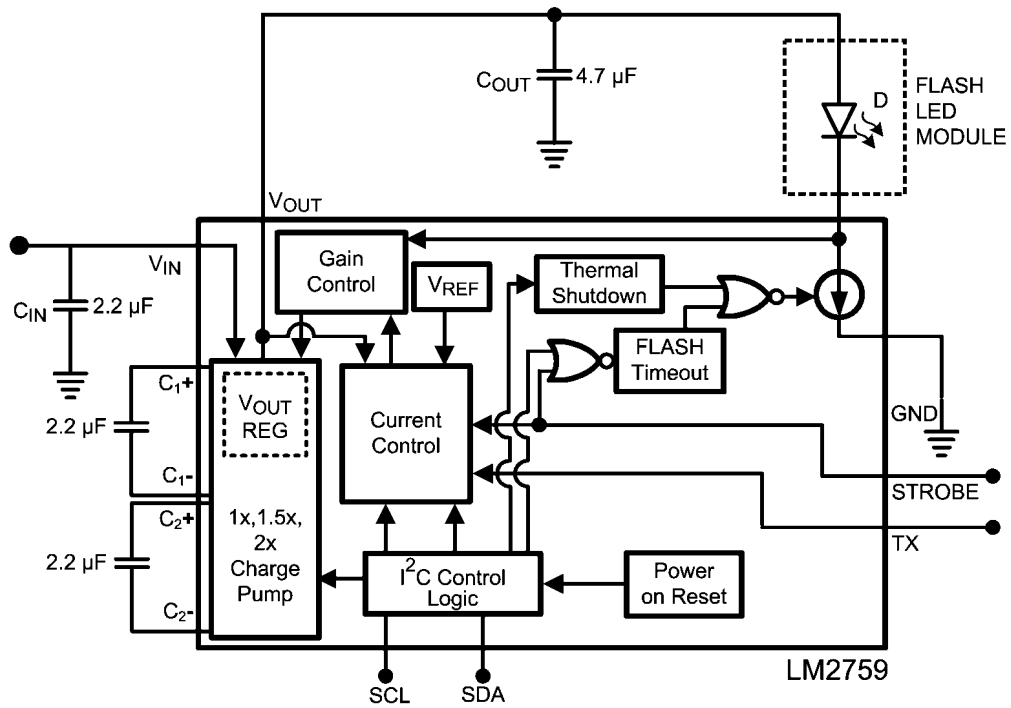

30069319

Typical Performance Characteristics

Unless otherwise specified: $T_A = 25^\circ\text{C}$, $V_{IN} = 3.6\text{V}$, $C_{IN} = C_1 = C_2 = 2.2\mu\text{F}$, $C_{OUT} = 4.7\mu\text{F}$. Capacitors are low-ESR multi-layer ceramic capacitors (MLCC's). Luxeon PWF3 Flash LED.

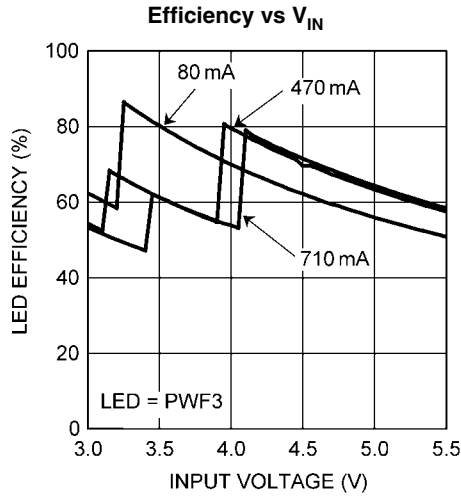

30069326

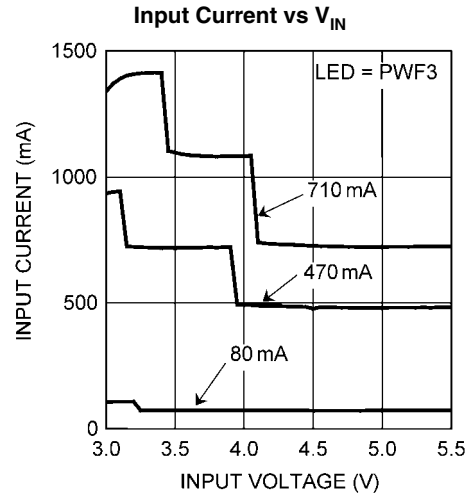

30069327

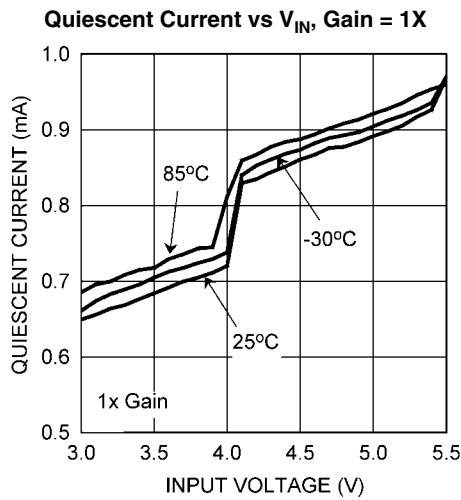

30069328

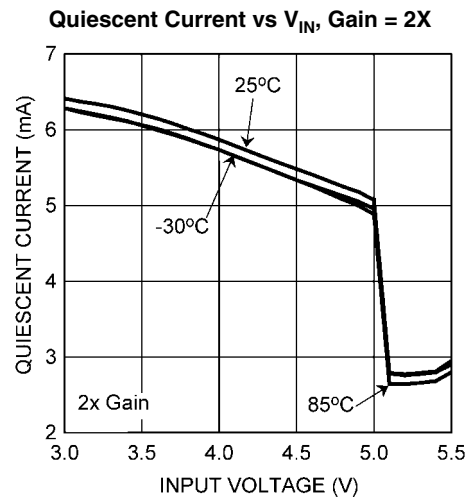

30069329

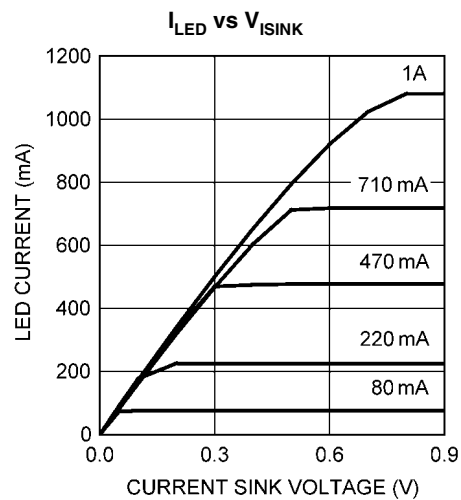

30069330

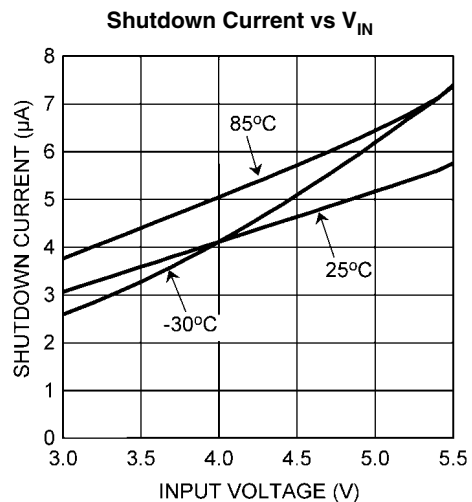

30069320

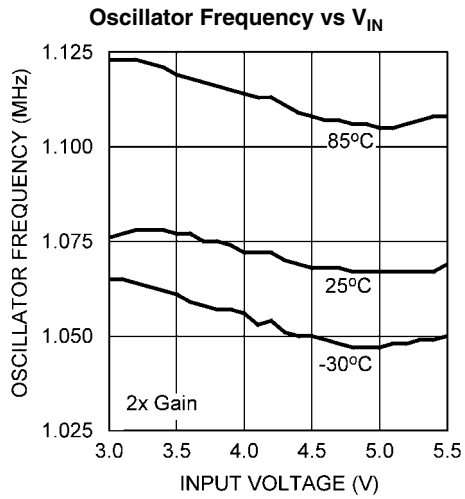

30069321

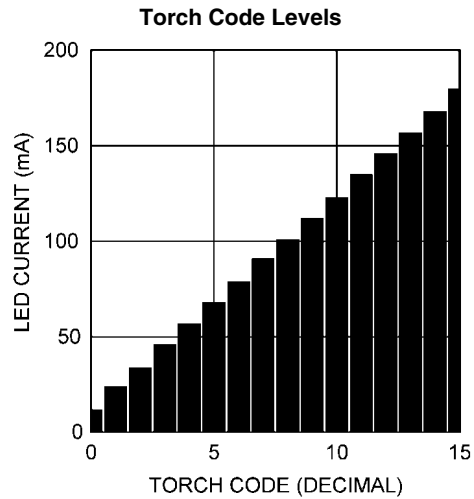

30069331

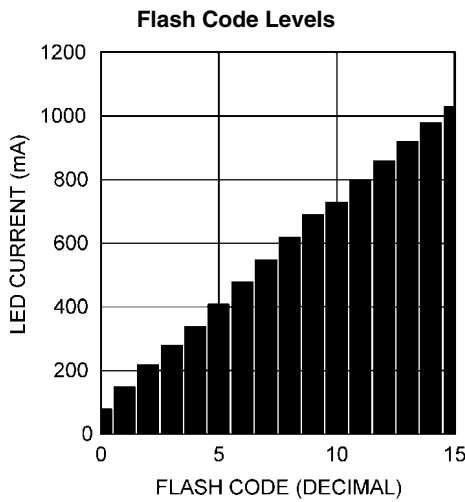

30069332

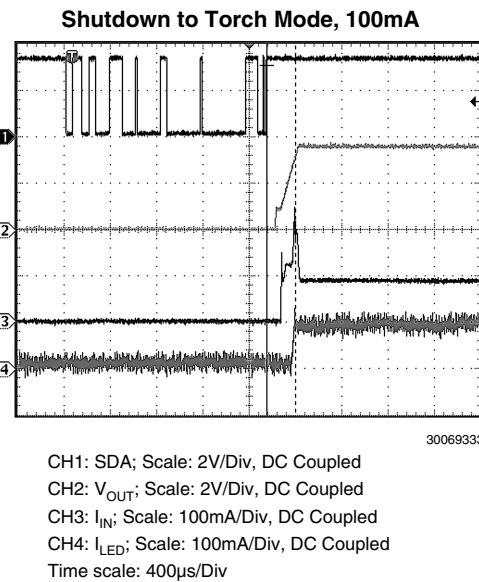

30069333

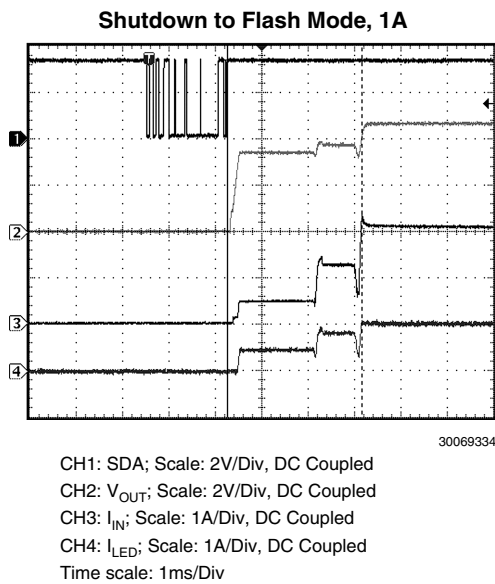

30069334

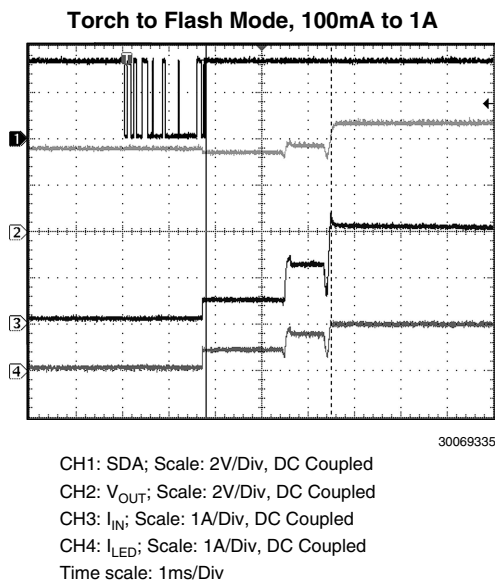

30069335

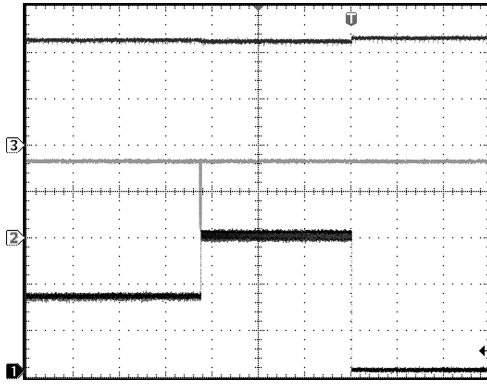
Flash Timeout, Timeout Code (x03) = 325ms

Torch Level (x0F) = 180mA, Flash Level (x05) = 410mA
CH1(bottom): I_{IN} ; Scale: 200mA/Div, DC Coupled
CH2(middle): SDA; Scale: 2V/Div, DC Coupled
CH3(top): V_{OUT} ; Scale: 2V/Div, DC Coupled
Time scale: 100ms/Div

Application Information

CIRCUIT DESCRIPTION

The LM2759 is an adaptive CMOS charge pump with gains of 1x, 1.5x, and 2x, optimized for driving Flash LEDs in camera phones and other portable applications. It provides a constant current of up to 1A (typ.) for Flash mode and 180 mA (typ.) for Torch mode.

The LM2759 has selectable modes including Flash, Torch, Indicator and Shutdown. Flash mode for the LM2759 can also be enabled via the Strobe input pin. The LED is driven from V_{OUT} and connected to the current sink. The LED drive current and operating modes are programmed via an I²C compatible interface. The LM2759 adaptively selects the next highest gain mode when needed to maintain the programmed LED current level.

To prevent a high battery load condition during a simultaneous RF PA transmission and Flash event, LM2759 has a Flash interrupt pin (TX) to reduce the LED current to the programmed Torch current level for the duration of the RF PA transmission pulse.

CHARGE PUMP AND GAIN TRANSITIONS

The input to the 1x, 1.5x, 2x charge pump is connected to the V_{IN} pin, and the loosely regulated output of the charge pump is connected to the V_{OUT} pin. In 1x mode, as long as the input voltage is less than 4.7V (typ.), the output voltage is approximately equal to the input voltage. When the input voltage is over 4.7V (typ.) the output voltage is regulated to 4.7V (typ.). In 1.5x mode, the output voltage is regulated to 4.7V (typ.) over entire input voltage range. For the gain of 2x, the output voltage is regulated to 5.1V (typ.). When under load, the voltage at V_{OUT} can be less than the target regulation voltage while the charge pump is still in closed loop operation. This is due to the load regulation topology of the LM2759.

The charge pump's gain is selected according to the headroom voltage across the current sink of LM2759. When the headroom voltage V_{GDX} (at the LED cathode) drops below 350 mV (typ.) the charge pump gain transitions to the next available higher gain mode. Once the charge pump transitions to a higher gain, it will remain at that gain for as long as the device remains enabled. Shutting down and then re-enabling the device resets the gain mode to the minimum gain required to maintain the load.

SOFT START

The LM2759 contains internal soft-start circuitry to limit inrush currents when the part is enabled. Soft start is implemented internally with a controlled turn-on of the internal voltage reference.

CURRENT LIMIT PROTECTION

The LM2759 charge pump contains current limit protection circuitry that protects the device during V_{OUT} fault conditions where excessive current is drawn. Output current is limited to 1.4A typically.

LOGIC CONTROL PINS

LM2759 has two asynchronous logic pins, Strobe and TX. These logic inputs function according to the table below:

TX	STROBE	FUNCTION
0	0	Current I ² C programmed state (Off, Torch, Flash, Indicator)
1	0	Current I ² C programmed state (Off, Torch, Flash, Indicator). If Flash is enabled via I ² C and TX is logic High, the LED current will be at the programmed Torch level.
0	1	Flash Mode (Total LED "ON" Duration limited by Flash Timeout)
1	1	Torch Mode (Total LED "ON" Duration limited by Flash Timeout)

I²C COMPATIBLE INTERFACE

START AND STOP CONDITIONS

START and STOP conditions classify the beginning and the end of the I²C session. A START condition is defined as SDA signal transitioning from HIGH to LOW while SCL line is HIGH. A STOP condition is defined as the SDA transitioning from LOW to HIGH while SCL is HIGH. The I²C master always generates START and STOP conditions. The I²C bus is considered to be busy after a START condition and free after a STOP condition. During data transmission, the I²C master can generate repeated START conditions. First START and repeated START conditions are equivalent, function-wise.

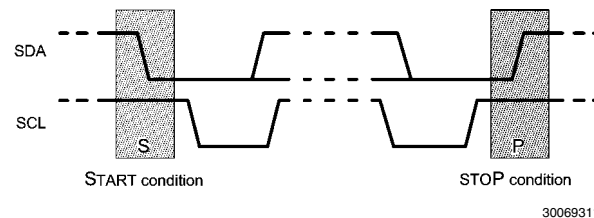

FIGURE 1. Start and Stop Conditions

DATA VALIDITY

The data on SDA line must be stable during the HIGH period of the clock signal (SCL). In other words, state of the data line can only be changed when SCL is LOW.

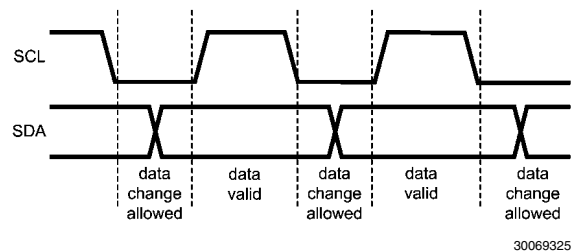

FIGURE 2. Data Validity Diagram

A pull-up resistor between the controller's VIO line and SDA must be greater than $[(VIO - V_{OL}) / 3.5mA]$ to meet the V_{OL} requirement on SDA. Using a larger pull-up resistor results in lower switching current with slower edges, while using a smaller pull-up results in higher switching currents with faster edges.

TRANSFERRING DATA

Every byte put on the SDA line must be eight bits long, with the most significant bit (MSB) transferred first. Each byte of

data has to be followed by an acknowledge bit. The acknowledge related clock pulse is generated by the master. The master releases the SDA line (HIGH) during the acknowledge clock pulse. The LM2759 pulls down the SDA line during the 9th clock pulse, signifying an acknowledge. The LM2759 generates an acknowledge after each byte is received.

After the START condition, the I²C master sends a chip address. This address is seven bits long followed by an eighth

bit which is a data direction bit (R/W). The LM2759 address is 53h. For the eighth bit, a "0" indicates a WRITE and a "1" indicates a READ. The second byte selects the register to which the data will be written. The third byte contains data to write to the selected register.

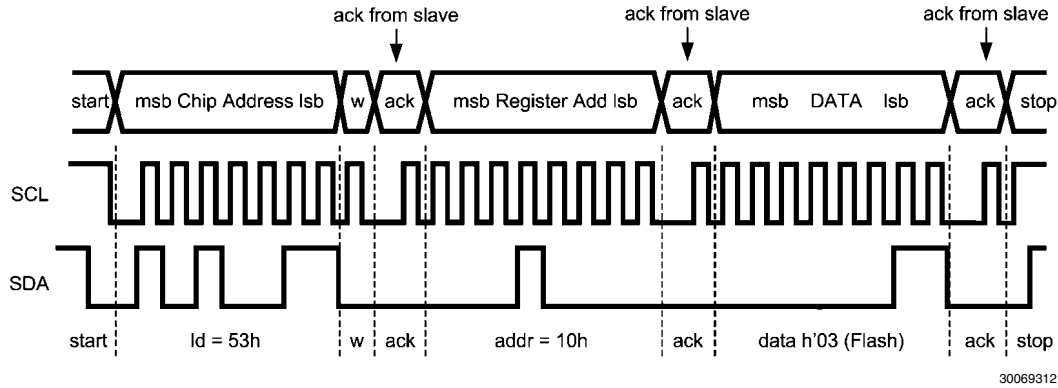

FIGURE 3. Write Cycle
 w = write (SDA = "0")
 r = read (SDA = "1")
 ack = acknowledge (SDA pulled down by either master or slave)
 id = chip address, 53h for LM2759

I²C COMPATIBLE CHIP ADDRESS

The chip address for LM2759 is 1010011, or 53h.



INTERNAL REGISTERS

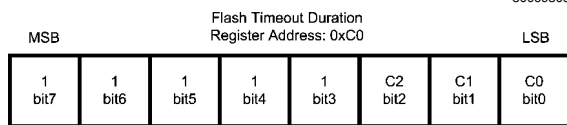
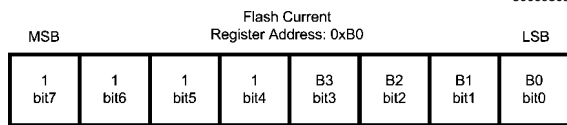
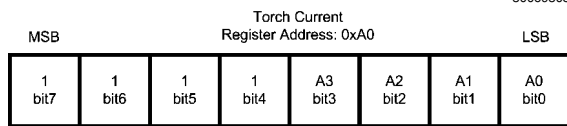
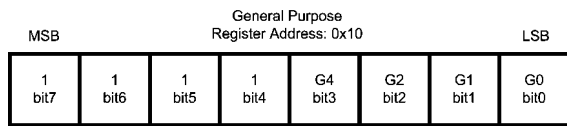

Register	Internal Hex Address	Power On Value (lowest 4 bits)
General Purpose Register	10h	0000
Flash Current Register	B0h	1010
Torch Current Register	A0h	0111
Flash Timeout Duration Register	C0h	1011

GENERAL PURPOSE REGISTER AND STROBE INHIBIT FUNCTION

The general purpose register (x10) is used set the mode of operation for the LM2759. The selectable operating modes using the lower 4 bits in the general purpose register are listed in the table below.

The Strobe Input Pin can be disabled via I²C to ignore external signals into this pin when desired. This function is implemented through bit 3 of the General Purpose Register (See table below). In the default state, input signals on the Strobe Input are enabled. (Bit3 = "0", inputs into the Strobe Pin are not inhibited).

General Purpose Register (Reg x10)				
Bit3	Bit2	Bit1	Bit0	Mode
X	X	X	0	Shutdown
X	0	0	1	Torch
X	X	1	1	Flash
X	1	0	1	Indicator (Lowest Torch Level)
1	X	X	X	Inhibit Inputs into the Strobe Pin

SETTING LED CURRENT

The current through the LED is set by programming the appropriate register with the desired current level code for Flash and Torch. The time that Flash mode is active is dependent on the lesser of the duration that it is set to "ON" (via I²C or the Strobe pin), or the duration of the Flash Timeout. Use the tables below to select the desired current level.

Using the part in conditions where the junction temperature might rise above the rated maximum requires that the operating ranges and/or conditions be de-rated. The printed circuit board also must be carefully laid out to account for high thermal dissipation in the part.

Flash Current Table (Reg xB0)

CODE (Hex)	FLASH CURRENT (mA)
00	80
01	150
02	220
03	280
04	350
05	410
06	470
07	530
08	590
09	650
0A	710
0B	770
0C	830
0D	890
0E	950
0F	1010

Torch Current Table (Reg xA0)

CODE (Hex)	TORCH CURRENT (mA)
00	15
01	30
02	40
03	50
04	65
05	80
06	90
07	100
08	110
09	120
0A	130
0B	140
0C	150
0D	160
0E	170
0F	180

FLASH TIME-OUT FEATURE

Time-out Protection Circuitry disables the current sink when either the Strobe pin is held at logic high or the Flash mode is enabled via the I²C compatible interface longer than the programmed timeout duration. This prevents the device from self-heating due to the high power dissipation during Flash conditions. During the time-out condition, voltage will still be present on V_{OUT} but the current sink will be shut off, resulting in no current through the Flash LED. When the device goes into a time-out condition, disabling and then re-enabling the device will reset the time-out. Use the table below to set the desired Flash timeout duration.

Flash Timeout Duration (Reg xC0)

CODE (Hex)	TIME (ms)
00	60
01	125
02	250
03	375
04	500
05	625
06	750
07	1100

CAPACITOR SELECTION

The LM2759 requires 4 external capacitors for proper operation. Surface-mount multi-layer ceramic capacitors are recommended. These capacitors are small, inexpensive and have very low equivalent series resistance (ESR <20 mΩ typ.). Tantalum capacitors, OS-CON capacitors, and aluminum electrolytic capacitors are not recommended for use with the LM2759 due to their high ESR, as compared to ceramic capacitors. For most applications, ceramic capacitors with X7R or X5R temperature characteristic are preferred for use with the LM2759. These capacitors have tight capacitance tolerance (as good as ±10%) and hold their value over temperature (X7R: ±15% over -55°C to 125°C; X5R: ±15% over -55°C to 85°C). Capacitors with Y5V or Z5U temperature characteristic are generally not recommended for use with the LM2759. Capacitors with these temperature characteristics typically have wide capacitance tolerance (+80%, -20%) and vary significantly over temperature (Y5V: +22%, -82% over -30°C to +85°C range; Z5U: +22%, -56% over +10°C to +85°C range). Under some conditions, a nominal 1 μF Y5V or Z5U capacitor could have a capacitance of only 0.1 μF. Such detrimental deviation is likely to cause Y5V and Z5U capacitors to fail to meet the minimum capacitance requirements of the LM2759. The voltage rating of the output capacitor should be 6.3V or more. For example, a 6.3V 0603 4.7 μF output capacitor (TDK C1608X5R0J475) is acceptable for use with the LM2759, as long as the capacitance on the output does not fall below a minimum of 3 μF in the intended application. All other capacitors should have a voltage rating at or above the maximum input voltage of the application and should have a minimum capacitance of 1 μF.

Suggested Capacitors and Suppliers

MFG Part No.	Type	MFG	Voltage Rating	Case Size	Inch (mm)
4.7 μF for C_{OUT}					
C1608X5R0J475	Ceramic X5R	TDK	6.3V	0603 (1608)	
JMK107BJ475	Ceramic X5R	Taiyo-Yuden	6.3V	0603 (1608)	
2.2 μF for C1, C2, C_{IN}					
C1608X5R0J225	Ceramic X5R	TDK	6.3V	0603 (1608)	
JMK107BJ225	Ceramic X5R	Taiyo-Yuden	6.3V	0603 (1608)	

POWER EFFICIENCY

Efficiency of LED drivers is commonly taken to be the ratio of power consumed by the LED (P_{LED}) to the power drawn at the input of the part (P_{IN}). With a 1x, 1.5x, 2x charge pump, the input current is equal to the charge pump gain times the output current (total LED current). The efficiency of the LM2759 can be predicted as follows:

$$P_{LED} = V_{LED} \times I_{LED}$$

$$P_{IN} = V_{IN} \times I_{IN}$$

$$P_{IN} = V_{IN} \times (\text{Gain} \times I_{LED} + I_Q)$$

$$E = (P_{LED} \div P_{IN})$$

For a simple approximation, the current consumed by internal circuitry (I_Q) can be neglected, and the resulting efficiency will become:

$$E = V_{LED} \div (V_{IN} \times \text{Gain})$$

Neglecting I_Q will result in a slightly higher efficiency prediction, but this impact will be negligible due to the value of I_Q being very low compared to the typical Torch and Flash current levels (100mA - 1A). It is also worth noting that efficiency as defined here is in part dependent on LED voltage. Variation in LED voltage does not affect power consumed by the circuit and typically does not relate to the brightness of the LED. For an advanced analysis, it is recommended that power consumed by the circuit ($V_{IN} \times I_{IN}$) be evaluated rather than power efficiency.

THERMAL PROTECTION

Internal thermal protection circuitry disables the LM2759 when the junction temperature exceeds 150°C (typ.). This feature protects the device from being damaged by high die temperatures that might otherwise result from excessive power dissipation. The device will recover and operate normally when the junction temperature falls below 120°C (typ.). It is important that the board layout provide good thermal conduction to keep the junction temperature within the specified operating ratings.

POWER DISSIPATION

The power dissipation ($P_{DISSIPATION}$) and junction temperature (T_J) can be approximated with the equations below. P_{IN} is the power generated by the 1x, 1.5x, 2x charge pump, P_{LED} is the power consumed by the LED, T_A is the ambient temperature, and θ_{JA} is the junction-to-ambient thermal resistance for the 12 pin LLP package. V_{IN} is the input voltage to the LM2759, V_{LED} is the nominal LED forward voltage, and I_{LED} is the programmed LED current.

$$P_{DISSIPATION} = P_{IN} - P_{LED}$$

$$= (\text{Gain} \times V_{IN} \times I_{LED}) - (V_{LED} \times I_{LED})$$

$$T_J = T_A + (P_{DISSIPATION} \times \theta_{JA})$$

The junction temperature rating takes precedence over the ambient temperature rating. The LM2759 may be operated outside the ambient temperature rating, so long as the junction temperature of the device does not exceed the maximum operating rating of 105°C. The maximum ambient temperature rating must be derated in applications where high power dissipation and/or poor thermal resistance causes the junction temperature to exceed 105°C.

MAXIMUM OUTPUT CURRENT

The maximum LED current that can be used for a particular application depends on the rated forward voltage of the LED used, the input voltage range of the application, and the Gain mode of the LM2759's charge pump. The following equation can be used to approximate the relationship between the maximum LED current, the LED forward voltage, the minimum input voltage, and the charge pump gain:

$$(V_{IN_MIN} \times \text{Gain}) > (V_F + V_{HR}) + (I_{LED} \times R_{OUT_GAIN})$$

V_{HR} or the voltage required across the current sink to remain in regulation can be approximated by ($I_{LED} \times K_{HR}$), where K_{HR} is 0.8 mV/mA (typ). R_{OUT_GAIN} is the output impedance of the charge pump according to its gain mode. When using the equation above, keep in mind that the ($V_F + V_{HR}$) portion of the equation can not be greater than the nominal output regulation voltage for a particular gain. In other words, when making calculations for an application where the term ($V_F + V_{HR}$) is higher than a particular gain's regulation voltage, the next higher gain level must be used for the calculation.

Example: $V_F = 4V @ 1A$, Charge Pump in the Gain of 2x with a R_{OUT} of 2.25 Ω (typ.)

$$V_{IN_MIN} > [(4V + 0.8V) + (1A \times 2.25\Omega)] \div 2$$

$$V_{IN_MIN} > 3.53V \text{ (typ.)}$$

The maximum power dissipation in the LM2759 must also be taken into account when selecting the conditions for an application, such that the junction temperature of the device never exceeds its rated maximum. The input voltage range, operating temperature range, and/or current level of the application may have to be adjusted to keep the LM2759 within normal operating ratings.

BOARD LAYOUT CONSIDERATIONS

PC board layout is an important part of DC-DC converter design. Poor board layout can disrupt the performance of a DC-DC converter and surrounding circuitry by contributing to EMI, ground bounce, and resistive voltage loss in the traces. These can send erroneous signals to the DC-DC converter IC, resulting in poor regulation or instability. Poor layout can also result in re-flow problems leading to poor solder joints between the LLP package and board pads. Poor solder joints can result in erratic or degraded performance.

Physical Dimensions inches (millimeters) unless otherwise noted

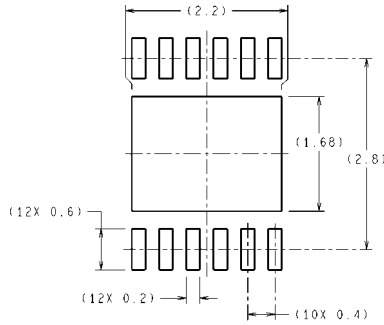

RECOMMENDED LAND PATTERN

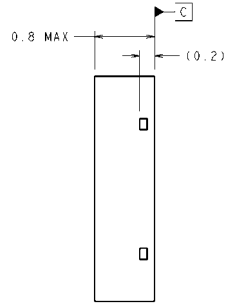
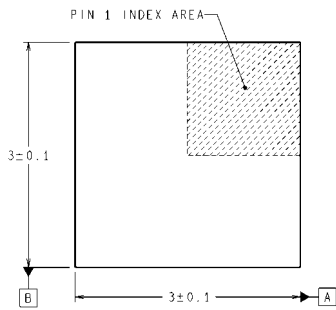

DIMENSIONS ARE IN MILLIMETERS
DIMENSIONS IN () FOR REFERENCE ONLY

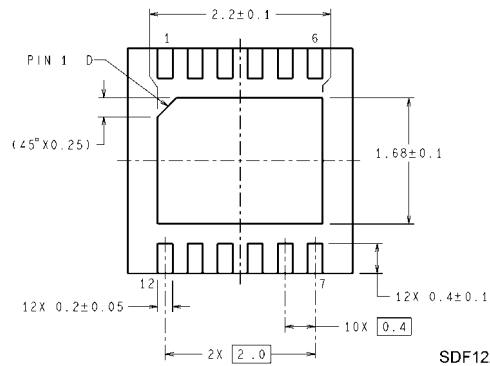
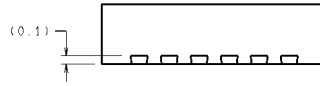

SDF12A (Rev B)

12-Pin LLP Package
NS Package Number SDF12A
X1 = X2 = 3.0mm
X3 = 0.8mm

Notes

For more National Semiconductor product information and proven design tools, visit the following Web sites at:
www.national.com

Products		Design Support	
Amplifiers	www.national.com/amplifiers	WEBENCH® Tools	www.national.com/webench
Audio	www.national.com/audio	App Notes	www.national.com/appnotes
Clock and Timing	www.national.com/timing	Reference Designs	www.national.com/refdesigns
Data Converters	www.national.com/adc	Samples	www.national.com/samples
Interface	www.national.com/interface	Eval Boards	www.national.com/evalboards
LVDS	www.national.com/lvds	Packaging	www.national.com/packaging
Power Management	www.national.com/power	Green Compliance	www.national.com/quality/green
Switching Regulators	www.national.com/switchers	Distributors	www.national.com/contacts
LDOs	www.national.com/lido	Quality and Reliability	www.national.com/quality
LED Lighting	www.national.com/led	Feedback/Support	www.national.com/feedback
Voltage References	www.national.com/vref	Design Made Easy	www.national.com/easy
PowerWise® Solutions	www.national.com/powerwise	Applications & Markets	www.national.com/solutions
Serial Digital Interface (SDI)	www.national.com/sdi	Mil/Aero	www.national.com/milaero
Temperature Sensors	www.national.com/tempensors	SolarMagic™	www.national.com/solarmagic
PLL/VCO	www.national.com/wireless	PowerWise® Design University	www.national.com/training

THE CONTENTS OF THIS DOCUMENT ARE PROVIDED IN CONNECTION WITH NATIONAL SEMICONDUCTOR CORPORATION ("NATIONAL") PRODUCTS. NATIONAL MAKES NO REPRESENTATIONS OR WARRANTIES WITH RESPECT TO THE ACCURACY OR COMPLETENESS OF THE CONTENTS OF THIS PUBLICATION AND RESERVES THE RIGHT TO MAKE CHANGES TO SPECIFICATIONS AND PRODUCT DESCRIPTIONS AT ANY TIME WITHOUT NOTICE. NO LICENSE, WHETHER EXPRESS, IMPLIED, ARISING BY ESTOPPEL OR OTHERWISE, TO ANY INTELLECTUAL PROPERTY RIGHTS IS GRANTED BY THIS DOCUMENT.

TESTING AND OTHER QUALITY CONTROLS ARE USED TO THE EXTENT NATIONAL DEEMS NECESSARY TO SUPPORT NATIONAL'S PRODUCT WARRANTY. EXCEPT WHERE MANDATED BY GOVERNMENT REQUIREMENTS, TESTING OF ALL PARAMETERS OF EACH PRODUCT IS NOT NECESSARILY PERFORMED. NATIONAL ASSUMES NO LIABILITY FOR APPLICATIONS ASSISTANCE OR BUYER PRODUCT DESIGN. BUYERS ARE RESPONSIBLE FOR THEIR PRODUCTS AND APPLICATIONS USING NATIONAL COMPONENTS. PRIOR TO USING OR DISTRIBUTING ANY PRODUCTS THAT INCLUDE NATIONAL COMPONENTS, BUYERS SHOULD PROVIDE ADEQUATE DESIGN, TESTING AND OPERATING SAFEGUARDS.

EXCEPT AS PROVIDED IN NATIONAL'S TERMS AND CONDITIONS OF SALE FOR SUCH PRODUCTS, NATIONAL ASSUMES NO LIABILITY WHATSOEVER, AND NATIONAL DISCLAIMS ANY EXPRESS OR IMPLIED WARRANTY RELATING TO THE SALE AND/OR USE OF NATIONAL PRODUCTS INCLUDING LIABILITY OR WARRANTIES RELATING TO FITNESS FOR A PARTICULAR PURPOSE, MERCHANTABILITY, OR INFRINGEMENT OF ANY PATENT, COPYRIGHT OR OTHER INTELLECTUAL PROPERTY RIGHT.

LIFE SUPPORT POLICY

NATIONAL'S PRODUCTS ARE NOT AUTHORIZED FOR USE AS CRITICAL COMPONENTS IN LIFE SUPPORT DEVICES OR SYSTEMS WITHOUT THE EXPRESS PRIOR WRITTEN APPROVAL OF THE CHIEF EXECUTIVE OFFICER AND GENERAL COUNSEL OF NATIONAL SEMICONDUCTOR CORPORATION. As used herein:

Life support devices or systems are devices which (a) are intended for surgical implant into the body, or (b) support or sustain life and whose failure to perform when properly used in accordance with instructions for use provided in the labeling can be reasonably expected to result in a significant injury to the user. A critical component is any component in a life support device or system whose failure to perform can be reasonably expected to cause the failure of the life support device or system or to affect its safety or effectiveness.

National Semiconductor and the National Semiconductor logo are registered trademarks of National Semiconductor Corporation. All other brand or product names may be trademarks or registered trademarks of their respective holders.

Copyright© 2010 National Semiconductor Corporation

For the most current product information visit us at www.national.com



National Semiconductor Americas Technical Support Center
 Email: support@nsc.com
 Tel: 1-800-272-9959

National Semiconductor Europe Technical Support Center
 Email: europe.support@nsc.com

National Semiconductor Asia Pacific Technical Support Center
 Email: ap.support@nsc.com

National Semiconductor Japan Technical Support Center
 Email: jpn.feedback@nsc.com