

# NSI45020JZT1G

## Adjustable Constant Current Regulator & LED Driver

45 V, 20 – 40 mA ± 15%, 1.5 W Package

The adjustable constant current regulator (CCR) is a simple, economical and robust device designed to provide a cost effective solution for regulating current in LEDs. The CCR is based on patent-pending Self-Biased Transistor (SBT) technology and regulates current over a wide voltage range. It is designed with a negative temperature coefficient to protect LEDs from thermal runaway at extreme voltages and currents.

The CCR turns on immediately and is at 20% of regulation with only 0.5 V  $V_{ak}$ . The  $R_{adj}$  pin allows  $I_{reg(SS)}$  to be adjusted to higher currents by attaching a resistor between  $R_{adj}$  (Pin 3) and the Cathode (Pin 4). The  $R_{adj}$  pin can also be left open (No Connect) if no adjustment is required. It requires no external components allowing it to be designed as a high or low-side regulator. The high anode-cathode voltage rating withstands surges common in Automotive, Industrial and Commercial Signage applications. This device is available in a thermally robust package and is qualified to stringent AEC-Q101 standard, which is lead-free RoHS compliant and uses halogen-free molding compound.

### Features

- Robust Power Package: 1.5 Watts
- Adjustable up to 40 mA
- Wide Operating Voltage Range
- Immediate Turn-On
- Voltage Surge Suppressing – Protecting LEDs
- AEC-Q101 Qualified
- SBT (Self-Biased Transistor) Technology
- Negative Temperature Coefficient
- Eliminates Additional Regulation
- These Devices are Pb-Free, Halogen Free/BFR Free and are RoHS Compliant

### Applications

- Automobile: Chevron Side Mirror Markers, Cluster, Display & Instrument Backlighting, CHMSL, Map Light
- AC Lighting Panels, Display Signage, Decorative Lighting, Channel Lettering
- Switch Contact Wetting
- Application Note AND8349/D – Automotive CHMSL
- Application Note AND8391/D – Power Dissipation Considerations



ON Semiconductor®

<http://onsemi.com>

$I_{reg(SS)} = 20 - 40 \text{ mA}$   
@  $V_{ak} = 7.5 \text{ V}$

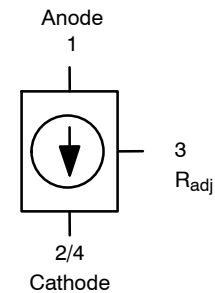

SOT-223  
CASE 318E  
STYLE 2

### MARKING DIAGRAM

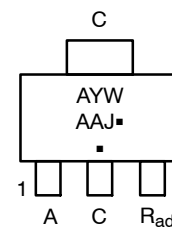

A = Assembly Location  
Y = Year  
W = Work Week  
AAJ = Specific Device Code  
▪ = Pb-Free Package

(Note: Microdot may be in either location)

### ORDERING INFORMATION

Device	Package	Shipping†
NSI45020JZT1G	SOT-223 (Pb-Free)	1000/Tape & Reel

†For information on tape and reel specifications, including part orientation and tape sizes, please refer to our Tape and Reel Packaging Specifications Brochure, BRD8011/D.

# NSI45020JZT1G

## MAXIMUM RATINGS (T<sub>A</sub> = 25°C unless otherwise noted)

Rating	Symbol	Value	Unit
Anode-Cathode Voltage	V <sub>AK</sub> Max	45	V
Reverse Voltage	V <sub>R</sub>	500	mV
Operating and Storage Junction Temperature Range	T <sub>J</sub> , T <sub>stg</sub>	-55 to +150	°C
ESD Rating:	Human Body Model Machine Model	ESD	Class 2 Class C

Stresses exceeding Maximum Ratings may damage the device. Maximum Ratings are stress ratings only. Functional operation above the Recommended Operating Conditions is not implied. Extended exposure to stresses above the Recommended Operating Conditions may affect device reliability.

## ELECTRICAL CHARACTERISTICS (T<sub>A</sub> = 25°C unless otherwise noted)

Characteristic	Symbol	Min	Typ	Max	Unit
Steady State Current @ V <sub>AK</sub> = 7.5 V (Note 1)	I <sub>reg(SS)</sub>	17	20	23	mA
Voltage Overhead (Note 2)	V <sub>overhead</sub>		1.8		V
Pulse Current @ V <sub>AK</sub> = 7.5 V (Note 3)	I <sub>reg(P)</sub>	17.15		23.4	mA
Capacitance @ V <sub>AK</sub> = 7.5 V (Note 4)	C		7.4		pF
Capacitance @ V <sub>AK</sub> = 0 V (Note 4)	C		31		pF

- I<sub>reg(SS)</sub> steady state is the voltage (V<sub>AK</sub>) applied for a time duration ≥ 35 sec, using FR-4 @ 300 mm<sup>2</sup> 2 oz. Copper traces, in still air.
- V<sub>overhead</sub> = V<sub>in</sub> - V<sub>LEDs</sub>. V<sub>overhead</sub> is typical value for 80% I<sub>reg(SS)</sub>.
- I<sub>reg(P)</sub> non-repetitive pulse test. Pulse width t ≤ 1.0 msec.
- f = 1 MHz, 0.02 V RMS.

## THERMAL CHARACTERISTICS

Characteristic	Symbol	Max	Unit
Total Device Dissipation (Note 5) T <sub>A</sub> = 25°C Derate above 25°C	P <sub>D</sub>	1008 8.06	mW mW/°C
Thermal Resistance, Junction-to-Ambient (Note 5)	R <sub>θJA</sub>	124	°C/W
Thermal Reference, Junction-to-Lead 4 (Note 5)	R <sub>ψJL4</sub>	33.3	°C/W
Total Device Dissipation (Note 6) T <sub>A</sub> = 25°C Derate above 25°C	P <sub>D</sub>	1136 9.09	mW mW/°C
Thermal Resistance, Junction-to-Ambient (Note 6)	R <sub>θJA</sub>	110	°C/W
Thermal Reference, Junction-to-Lead 4 (Note 6)	R <sub>ψJL4</sub>	33.3	°C/W
Total Device Dissipation (Note 7) T <sub>A</sub> = 25°C Derate above 25°C	P <sub>D</sub>	1238 9.9	mW mW/°C
Thermal Resistance, Junction-to-Ambient (Note 7)	R <sub>θJA</sub>	101	°C/W
Thermal Reference, Junction-to-Lead 4 (Note 7)	R <sub>ψJL4</sub>	33.7	°C/W
Total Device Dissipation (Note 8) T <sub>A</sub> = 25°C Derate above 25°C	P <sub>D</sub>	1420 11.36	mW mW/°C
Thermal Resistance, Junction-to-Ambient (Note 8)	R <sub>θJA</sub>	88	°C/W
Thermal Reference, Junction-to-Lead 4 (Note 8)	R <sub>ψJL4</sub>	32.1	°C/W
Total Device Dissipation (Note 9) T <sub>A</sub> = 25°C Derate above 25°C	P <sub>D</sub>	1316 10.53	mW mW/°C
Thermal Resistance, Junction-to-Ambient (Note 9)	R <sub>θJA</sub>	95	°C/W
Thermal Reference, Junction-to-Lead 4 (Note 9)	R <sub>ψJL4</sub>	32.4	°C/W
Total Device Dissipation (Note 10) T <sub>A</sub> = 25°C Derate above 25°C	P <sub>D</sub>	1506 12.05	mW mW/°C
Thermal Resistance, Junction-to-Ambient (Note 10)	R <sub>θJA</sub>	83	°C/W
Thermal Reference, Junction-to-Lead 4 (Note 10)	R <sub>ψJL4</sub>	30.8	°C/W
Junction and Storage Temperature Range	T <sub>J</sub> , T <sub>stg</sub>	-55 to +150	°C

NOTE: Lead measurements are made by non-contact methods such as IR with treated surface to increase emissivity to 0.9.

Lead temperature measurement by attaching a T/C may yield values as high as 30% higher °C/W values based upon empirical measurements and method of attachment.

- FR-4 @ 300 mm<sup>2</sup>, 1 oz. copper traces, still air.
- FR-4 @ 300 mm<sup>2</sup>, 2 oz. copper traces, still air.
- FR-4 @ 500 mm<sup>2</sup>, 1 oz. copper traces, still air.
- FR-4 @ 500 mm<sup>2</sup>, 2 oz. copper traces, still air.
- FR-4 @ 700 mm<sup>2</sup>, 1 oz. copper traces, still air.
- FR-4 @ 700 mm<sup>2</sup>, 2 oz. copper traces, still air.

TYPICAL PERFORMANCE CURVES

Minimum FR-4 @ 300 mm<sup>2</sup>, 2 oz Copper Trace, Still Air

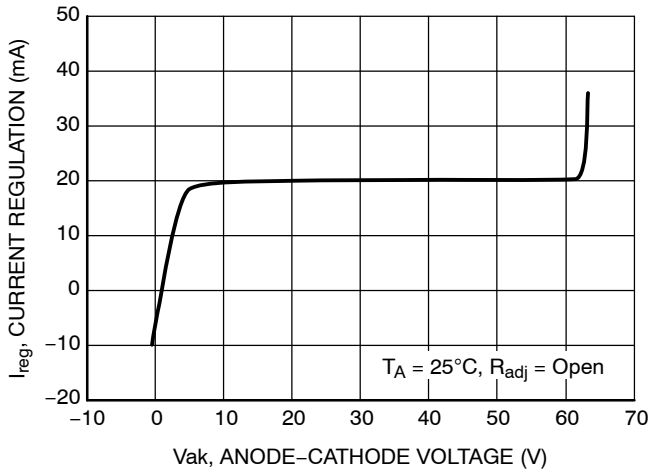

Figure 1. General Performance Curve for CCR

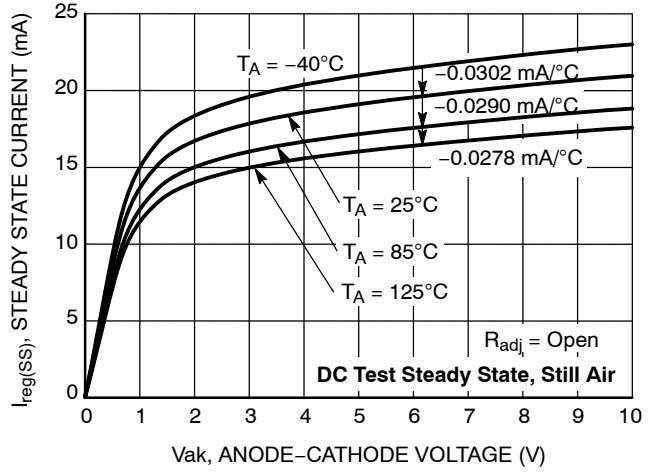

Figure 2. Steady State Current ( $I_{reg(SS)}$ ) vs. Anode-Cathode Voltage ( $V_{ak}$ )

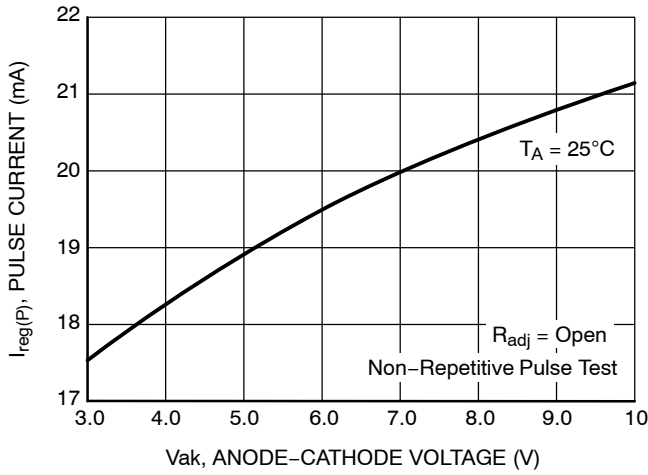

Figure 3. Pulse Current ( $I_{reg(P)}$ ) vs. Anode-Cathode Voltage ( $V_{ak}$ )

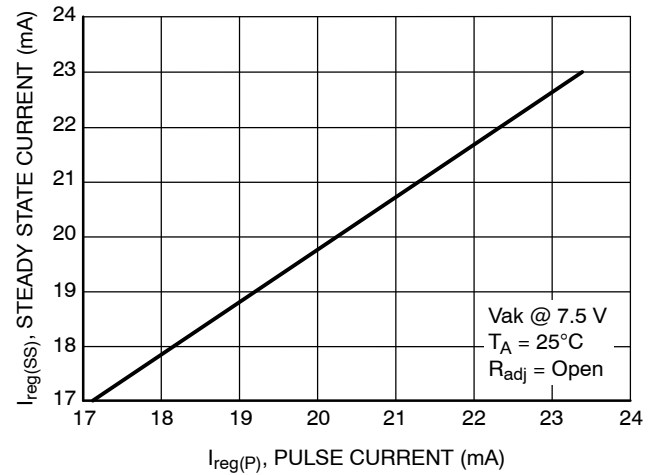

Figure 4. Steady State Current vs. Pulse Current Testing

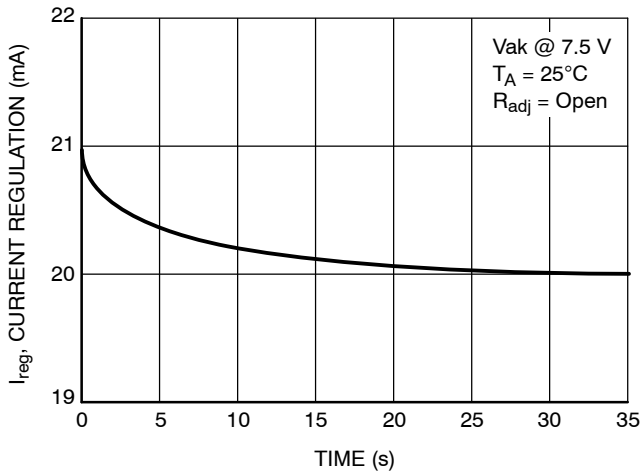

Figure 5. Current Regulation vs. Time

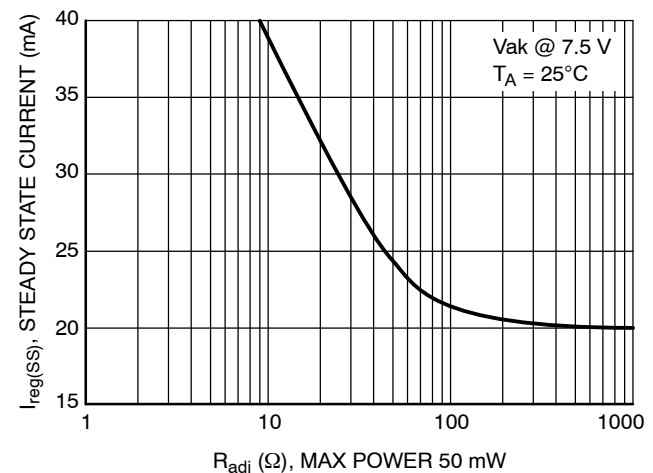
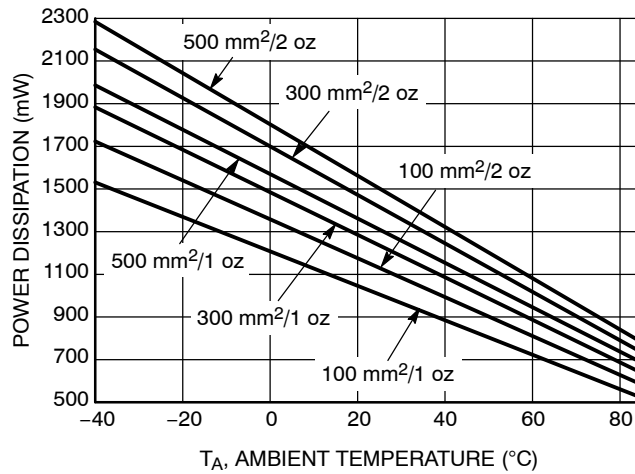

Figure 6.  $I_{reg(SS)}$  vs.  $R_{adj}$

# NSI45020JZT1G



**Figure 7. Power Dissipation vs. Ambient Temperature @  $T_J = 150^\circ\text{C}$**

## APPLICATIONS

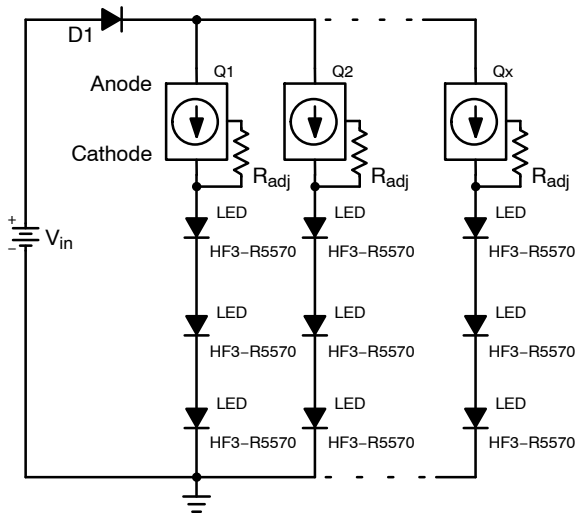

**Figure 8. Typical Application Circuit (30 mA each LED String)**

Number of LED's that can be connected is determined by:  
**D1 is a reverse battery protection diode**  
 $\text{LED's} = (V_{in} - Q_X V_F - D1 V_F) / \text{LED } V_F$   
**Example:**  $V_{in} = 12 \text{ Vdc}$ ,  $Q_X V_F = 3.5 \text{ Vdc}$ ,  $D1 V_F = 0.7 \text{ V}$   
 $\text{LED } V_F = 2.2 \text{ Vdc @ } 30 \text{ mA}$   
 $(12 \text{ Vdc} - 4.2 \text{ Vdc}) / 2.2 \text{ Vdc} = 3 \text{ LEDs in series.}$

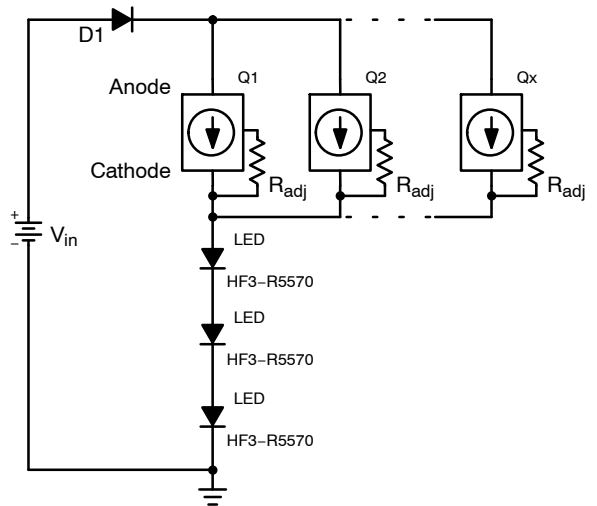

**Figure 9. Typical Application Circuit (90 mA each LED String)**

Number of LED's that can be connected is determined by:  
**D1 is a reverse battery protection diode**  
**Example:**  $V_{in} = 12 \text{ Vdc}$ ,  $Q_X V_F = 3.5 \text{ Vdc}$ ,  $D1 V_F = 0.7 \text{ V}$   
 $\text{LED } V_F = 2.6 \text{ Vdc @ } 90 \text{ mA}$   
 $(12 \text{ Vdc} - (3.5 + 0.7 \text{ Vdc})) / 2.6 \text{ Vdc} = 3 \text{ LEDs in series.}$   
**Number of Drivers = LED current / 30 mA**  
 $90 \text{ mA} / 30 \text{ mA} = 3 \text{ Drivers (Q1, Q2, Q3)}$

Comparison of LED Circuit using CCR vs. Resistor Biasing

ON Semiconductor CCR Design	Resistor Biased Design
Constant brightness over full Supply Voltage (more efficient), see Figure 10	Large variations in brightness over full Automotive Supply Voltage
Little variation of power in LEDs, see Figure 11	Large variations of current (power) in LEDs
Constant current extends LED strings lifetime, see Figure 10	High Supply Voltage/ Higher Current in LED strings limits lifetime
Current decreases as voltage increases, see Figure 10	Current increases as voltage increases
Current supplied to LED string decreases as temperature increases (self-limiting), see Figure 2	LED current decreases as temperature increases
Single resistor is used for current select	Requires costly inventory (need for several resistor values to match LED intensity)
Fewer components, less board space required	More components, more board space required
Surface mount component	Through-hole components

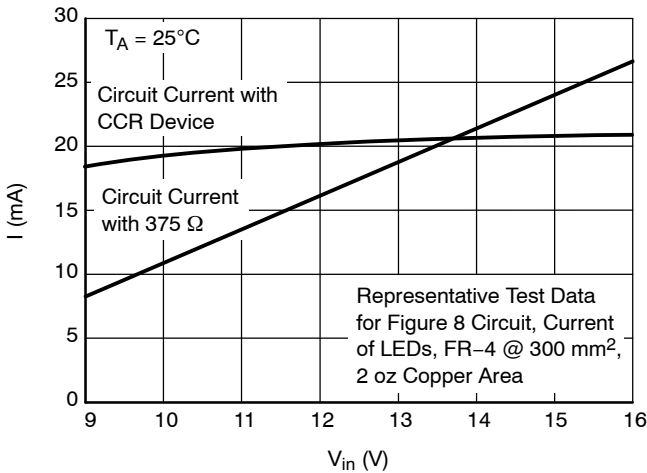

Figure 10. Series Circuit Current

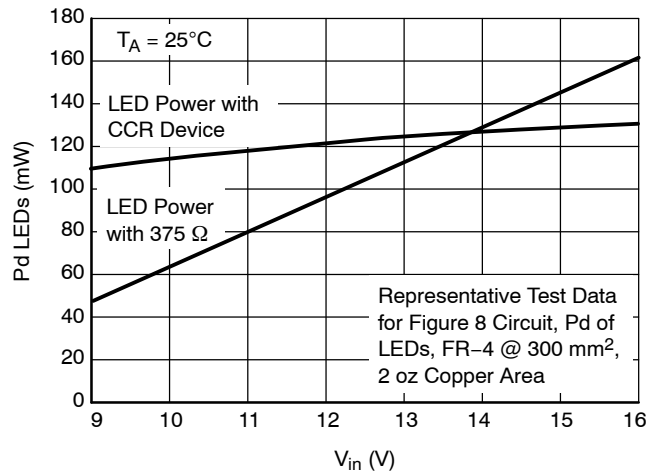

Figure 11. LED Power

Current Regulation: Pulse Mode ( $I_{reg(P)}$ ) vs DC Steady-State ( $I_{reg(SS)}$ )

There are two methods to measure current regulation: Pulse mode ( $I_{reg(P)}$ ) testing is applicable for factory and incoming inspection of a CCR where test times are a minimum. ( $t \leq 300 \mu\text{s}$ ). DC Steady-State ( $I_{reg(SS)}$ ) testing is applicable for application verification where the CCR will be operational for seconds, minutes, or even hours. ON Semiconductor has correlated the difference in  $I_{reg(P)}$  to

$I_{reg(SS)}$  for stated board material, size, copper area and copper thickness.  $I_{reg(P)}$  will always be greater than  $I_{reg(SS)}$  due to the die temperature rising during  $I_{reg(SS)}$ . This heating effect can be minimized during circuit design with the correct selection of board material, metal trace size and weight, for the operating current, voltage, board operating temperature ( $T_A$ ) and package. (Refer to Thermal Characteristics table).

# NSI45020JZT1G

## PACKAGE DIMENSIONS

SOT-223 (TO-261)  
CASE 318E-04  
ISSUE M

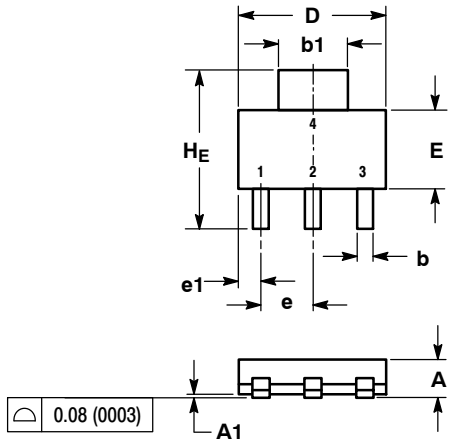

NOTES:

- DIMENSIONING AND TOLERANCING PER ANSI Y14.5M, 1982.
- CONTROLLING DIMENSION: INCH.

DIM	MILLIMETERS			INCHES		
	MIN	NOM	MAX	MIN	NOM	MAX
A	1.50	1.63	1.75	0.060	0.064	0.068
A1	0.02	0.06	0.10	0.001	0.002	0.004
b	0.60	0.75	0.89	0.024	0.030	0.035
b1	2.90	3.06	3.20	0.115	0.121	0.126
c	0.24	0.29	0.35	0.009	0.012	0.014
D	6.30	6.50	6.70	0.249	0.256	0.263
E	3.30	3.50	3.70	0.130	0.138	0.145
e	2.20	2.30	2.40	0.087	0.091	0.094
e1	0.85	0.94	1.05	0.033	0.037	0.041
L1	1.50	1.75	2.00	0.060	0.069	0.078
HE	6.70	7.00	7.30	0.264	0.276	0.287
θ	0°	-	10°	0°	-	10°

STYLE 2:

- PIN 1. ANODE
- CATHODE
- NC
- CATHODE

### SOLDERING FOOTPRINT

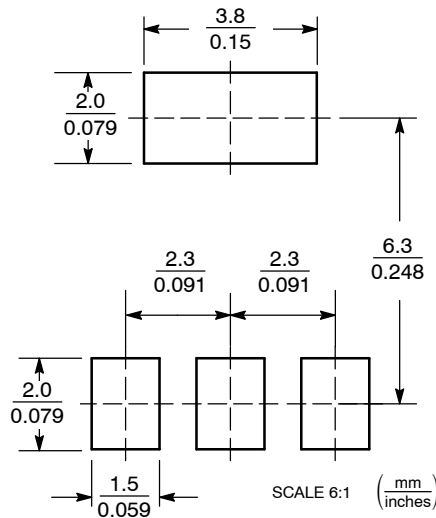

ON Semiconductor and are registered trademarks of Semiconductor Components Industries, LLC (SCILLC). SCILLC reserves the right to make changes without further notice to any products herein. SCILLC makes no warranty, representation or guarantee regarding the suitability of its products for any particular purpose, nor does SCILLC assume any liability arising out of the application or use of any product or circuit, and specifically disclaims any and all liability, including without limitation special, consequential or incidental damages. "Typical" parameters which may be provided in SCILLC data sheets and/or specifications can and do vary in different applications and actual performance may vary over time. All operating parameters, including "Typicals" must be validated for each customer application by customer's technical experts. SCILLC does not convey any license under its patent rights nor the rights of others. SCILLC products are not designed, intended, or authorized for use as components in systems intended for surgical implant into the body, or other applications intended to support or sustain life, or for any other application in which the failure of the SCILLC product could create a situation where personal injury or death may occur. Should Buyer purchase or use SCILLC products for any such unintended or unauthorized application, Buyer shall indemnify and hold SCILLC and its officers, employees, subsidiaries, affiliates, and distributors harmless against all claims, costs, damages, and expenses, and reasonable attorney fees arising out of, directly or indirectly, any claim of personal injury or death associated with such unintended or unauthorized use, even if such claim alleges that SCILLC was negligent regarding the design or manufacture of the part. SCILLC is an Equal Opportunity/Affirmative Action Employer. This literature is subject to all applicable copyright laws and is not for resale in any manner.

### PUBLICATION ORDERING INFORMATION

LITERATURE FULFILLMENT:

Literature Distribution Center for ON Semiconductor  
P.O. Box 5163, Denver, Colorado 80217 USA  
Phone: 303-675-2175 or 800-344-3860 Toll Free USA/Canada  
Fax: 303-675-2176 or 800-344-3867 Toll Free USA/Canada  
Email: orderlit@onsemi.com

N. American Technical Support: 800-282-9855 Toll Free USA/Canada  
Europe, Middle East and Africa Technical Support: Phone: 421 33 790 2910  
Japan Customer Focus Center Phone: 81-3-5773-3850

ON Semiconductor Website: [www.onsemi.com](http://www.onsemi.com)  
Order Literature: <http://www.onsemi.com/orderlit>  
For additional information, please contact your local Sales Representative

NSI45020JZ/D