

LM3508 Synchronous Magnetic Constant Current White LED Driver

General Description

The LM3508 is a synchronous boost converter (no external Schottky diode required) that provides a constant current output. It is designed to drive up to 4 series white LEDs at 30mA from a single-cell Li-Ion battery. A single low power external resistor is used to set the maximum LED current. The LED current can be adjusted by applying a PWM signal of up to 100kHz to the DIM pin. Internal soft-start circuitry is designed to eliminate high in-rush current at start-up. For maximum safety, the device features an advanced short-circuit protection when the output is shorted to ground. Additionally, over-voltage protection and an 850kHz switching frequency allow for the use of small, low-cost output capacitors with lower voltage ratings. During shutdown, the output is disconnected from the input preventing a leakage current path through the LEDs to ground. The LM3508 is available in a tiny 9-bump chip-scale micro-SMD package.

Features

- Drives 4 Series White LEDs with up to 30mA
- >80% Peak Efficiency
- Up to 100kHz PWM Brightness Control
- Accurate $\pm 5\%$ LED Current Regulation across V_{IN} range
- Internal Synchronous PFET (No Schottky Diode Required)
- True Shutdown Isolation
- Output Short-Circuit Protection
- 17.5V Over-Voltage Protection
- Internal Soft-Start Eliminates Inrush Current
- Wide Input Voltage Range: 2.7V to 5.5V
- 850kHz Fixed Frequency Operation
- Low Profile 9-Bump Micro-SMD Package (1.514mm x 1.514mm x 0.6mm)

Applications

- White LED Backlighting
- Handheld Devices
- Digital Cameras
- Portable Applications

Typical Application Circuit

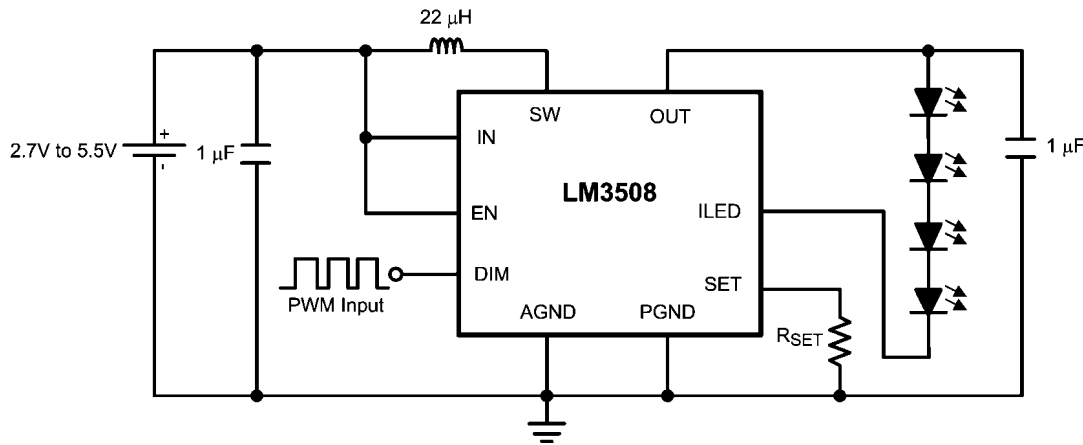

30004201

Connection Diagram

Top View

Top View

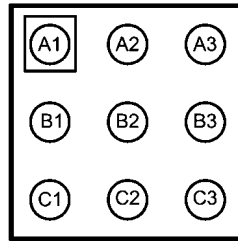

9-Bump (Large) μ -SMD (1.514mm x 1.514mm x 0.6mm) NS Package Number TLA09 ³⁰⁰⁰⁴²⁰²

Ordering Information

Part Number	Package Type	NSC Package Drawing	Top Mark	Supplied As
LM3508TL	9-Bump micro SMD	TL09SDA	D31	250 Units, Tape and Reel
LM3508TLX	9-Bump micro SMD	TL09SDA	D31	3000 Units, Tape and Reel

Pin Descriptions/Functions

Pin	Name	Function
A1	PGND	Power Ground Connection.
A2	SW	Inductor connection and drain connection for both NMOS and PMOS power devices.
A3	OUT	Output capacitor connection, PMOS source connection for synchronous rectifier, and OVP sensing node.
B1	ILED	Regulated current source input.
B2	DIM	Current source modulation input. A logic low at DIM turns off the internal current source. A logic high turns the LEDs fully on ($V_{SET}=200mV$). Apply a PWM signal at DIM for LED brightness control.
B3	IN	Input voltage connection.
C1	SET	Current sense connection and current source output. Connect a 1% resistor (R_{SET}) from SET to PGND to set the maximum LED current ($I_{LED} = 200mV/R_{SET}$).
C2	EN	Enable input. A logic low at EN turns off the LM3508. A logic high turns the device on.
C3	AGND	Analog ground. Connect AGND to PGND through a low impedance connection.

Absolute Maximum Ratings (Notes 1, 2)

If Military/Aerospace specified devices are required, please contact the National Semiconductor Sales Office/Distributors for availability and specifications.

V_{IN}	-0.3V to 6V
V_{OUT}	-0.3V to 22V
V_{SW}	-0.3V to 22V
V_{ILED} , V_{SET} , V_{DIM} , V_{EN}	-0.3V to 6V
Continuous Power Dissipation (Note)	Internally Limited
Junction Temperature	+150°C
Lead Temperature (Note 4)	+300°C
Storage Temperature Range	-65°C to +150°C
ESD Rating(Note 9)	
Human Body Model	2kV

Electrical Characteristics

Specifications in standard type face are for $T_A = 25^\circ\text{C}$ and those in **boldface type** apply over the Operating Temperature Range of $T_A = -30^\circ\text{C}$ to $+85^\circ\text{C}$. Unless otherwise specified $V_{IN} = 3.6\text{V}$. (Note 7)

Symbol	Parameter	Conditions	Min	Typ	Max	Units
I_D	LED Current Regulation	$R_{SET} = 10\Omega$		20		mA
		$R_{SET} = 6.67\Omega$		30		
V_{SET}	Voltage at SET Pin	$3.0\text{V} < V_{IN} < 5.5\text{V}$	190	200	210	mV
V_{ILED}	Voltage at ILED Pin			500		mV
V_{HR}	Current Sink Headroom Voltage	Where $I_{LED} = 95\%$ of nominal, $R_{SET} = 20\Omega$		400		mV
R_{DSON}	NMOS Switch On Resistance	$I_{SW} = 100\text{mA}$		0.5		Ω
	PMOS Switch On Resistance	$V_{OUT} = 10\text{V}$, $I_{SW} = 65\text{mA}$		2.2		
I_{CL}	NMOS Switch Current Limit		370	500	620	mA
I_{LSW}	SW Leakage Current	$V_{SW} = V_{IN} = 5.5\text{V}$, OUT Floating, $V_{EN} = \text{PGND}$		0.01		μA
$I_{OUT_SHUTDOWN}$	Output Pull-Down Resistance in Shutdown	$V_{EN} = 0\text{V}$		630		Ω
V_{OVP}	Output Over-Voltage Protection	ON Threshold (V_{OUT} rising)	17.5	19.8	21.8	V
		OFF Threshold (V_{OUT} falling)		18.6		
f_{SW}	Switching Frequency	$3.0\text{V} < V_{IN} < 5.5\text{V}$	715	850	1150	kHz
D_{MAX}	Maximum Duty Cycle			91		%
V_{SC}	Output Voltage Threshold for Short Circuit Detection	V_{OUT} Falling		$0.93 \times V_{IN}$		V
		V_{OUT} Rising		$0.95 \times V_{IN}$		
V_{EN_TH}	EN Threshold Voltage	On Threshold	1.1			V
		Off Threshold			0.5	
V_{DIM_TH}	DIM Threshold Voltage	On Threshold	1.1			V
		Off Threshold			0.5	
I_{DIM}	DIM Bias Current (Note 8)	$V_{DIM} = 1.8\text{V}$		4.7		μA

Operating Conditions (Notes 1, 2)

Input Voltage Range	2.7V to 5.5V
Ambient Temperature Range (Note 5)	-30°C to +85°C
Junction Temperature Range	-30°C to +105°C

Thermal Properties

Junction to Ambient Thermal Resistance (θ_{JA})(Note 6)	64.7°C/W
--	----------

ESD Caution Notice

National Semiconductor recommends that all integrated circuits be handled with appropriate ESD precautions. Failure to observe proper ESD handling techniques can result in damage to the device.

Symbol	Parameter	Conditions	Min	Typ	Max	Units
I_{EN}	EN Bias Current (Note 8)	$V_{EN} = 1.8V$		4.7		μA
I_{OUT}	OUT Bias Current	$V_{OUT} = 16V$, device not switching		420		μA
$R_{OUT_SHUTDOWN}$	Output Pull-Down Resistance in Shutdown	$V_{EN} = 0V$, $V_{OUT} < V_{IN}$		630		Ω
I_Q	Quiescent Current Device Not Switching	$V_{ILED} > 0.5V$, $3.0V < V_{IN} < 5.5V$, SW Floating		0.18	0.3	mA
		$V_{EN} = 0V$, $3.0V < V_{IN} < 5.5V$		0.01	0.5	
I_{Q_SW}	Switching Supply Current			825		μA
t_{START_UP}	From EN Low to High to Inductor Current Steady State	$V_{OUT} = 17V$, $I_{LED} = 20mA$		470		μs

Note 1: Absolute maximum ratings are limits beyond which damage to the device may occur. Operating Ratings are conditions for which the device is intended to be functional, but device parameter specifications may not be guaranteed. For guaranteed specifications and test conditions, see the Electrical Characteristics.

Note 2: All voltages are with respect to PGND.

Note 3: Internal thermal shutdown circuitry protects the device from permanent damage. Thermal shutdown engages at $T_J = +150^\circ C$ (typ.) and disengages at $T_J = +140^\circ C$ (typ.).

Note 4: For more detailed soldering information and specifications, please refer to National Semiconductor Application Note 1112: Micro SMD Wafer Level Chip Scale Package (AN-1112), available at www.national.com.

Note 5: In applications where high power dissipation and/or poor package thermal resistance is present, the maximum ambient temperature may have to be derated. Maximum ambient temperature (T_{A-MAX}) is dependent on the maximum operating junction temperature ($T_{J-MAX,OP} = +125^\circ C$), the maximum power dissipation of the device in the application (P_{D-MAX}), and the junction-to ambient thermal resistance of the part/package in the application (θ_{JA}), as given by the following equation: $T_{A-MAX} = T_{J-MAX,OP} - (\theta_{JA} \times P_{D-MAX})$.

Note 6: Junction-to-ambient thermal resistance (θ_{JA}) is taken from thermal modeling performed under the conditions and guidelines set forth in the JEDEC standard JESD51-7. The test board is a 4-layer FR-4 board measuring (102mm x 76mm x 1.6mm) with a 2 x 1 array of thermal vias. The ground plane on the board is (50mm x 50mm). Thickness of copper layers are (36 μm /18 μm /18 μm /36 μm) (1.5oz/1oz/1oz/1.5oz copper). Ambient temperature in simulation is +22 $^\circ C$, still air. Power dissipation is 1W.

Note 7: Min and Max limits are guaranteed by design, test, or statistical analysis. Typical numbers are not guaranteed, but do represent the most likely norm. Unless otherwise specified, conditions for typical specifications are $V_{IN} = 3.6V$, $T_A = +25^\circ C$.

Note 8: There is a typical 383k Ω pull-down on this pin.

Note 9: The human body model is a 100pF capacitor discharged through 1.5k Ω resistor into each pin. (MIL-STD-883 3015.7).

Typical Performance Characteristics $V_{IN} = 3.6V$, $R_{SET} = 10\Omega$, $L = TDK VLF3012AT-220MR33$ (22 μH), LEDs are OSRAM (LW M67C), $C_{OUT} = C_{IN} = 1\mu F$, $T_A = +25^\circ C$, unless otherwise noted.

4 LED Efficiency vs I_{LED}
($L = TDK VLF3012AT-220MR33$, $R_L = 0.66\Omega$)

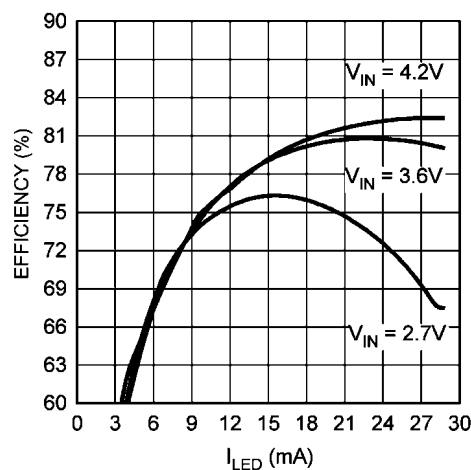

30004242

3 LED Efficiency vs I_{LED}
($L = TDK VLF3012AT-220MR33$, $R_L = 0.66\Omega$)

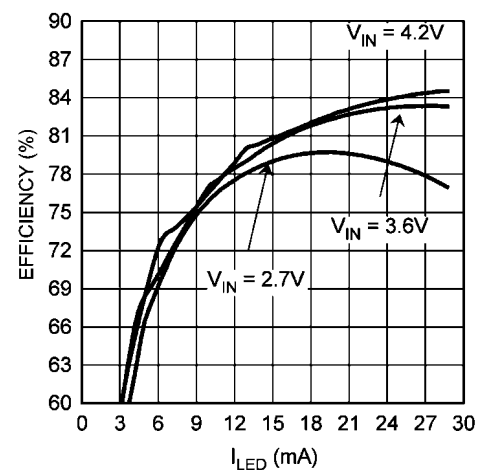

30004241

2 LED Efficiency vs I_{LED}
 (L = TDK VLF3012AT-220MR33, $R_L = 0.66\Omega$)

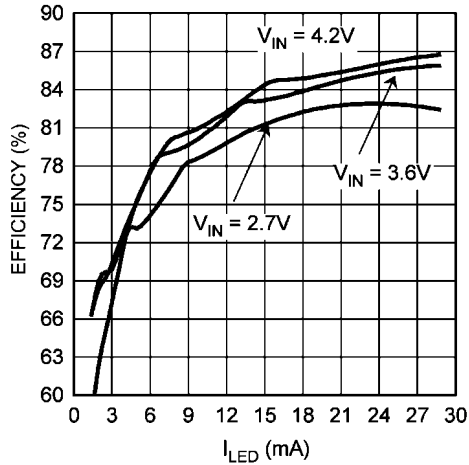

30004258

Converter Output Voltage vs LED Current

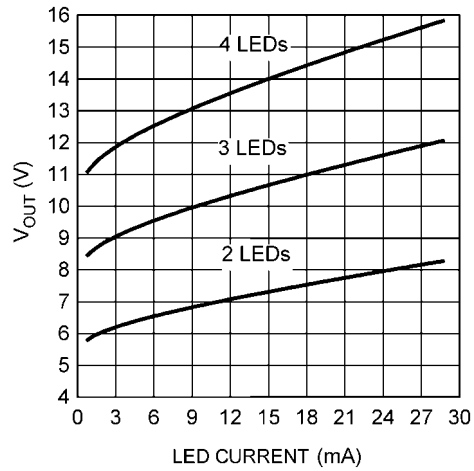

30004243

Efficiency vs V_{IN} ($I_{LED} = 20mA$)

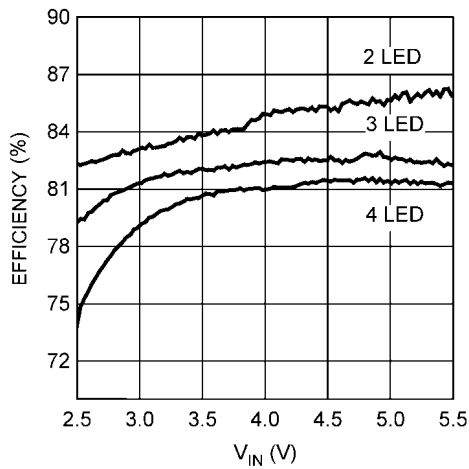

30004260

Efficiency vs V_{IN} ($I_{LED} = 30mA$)

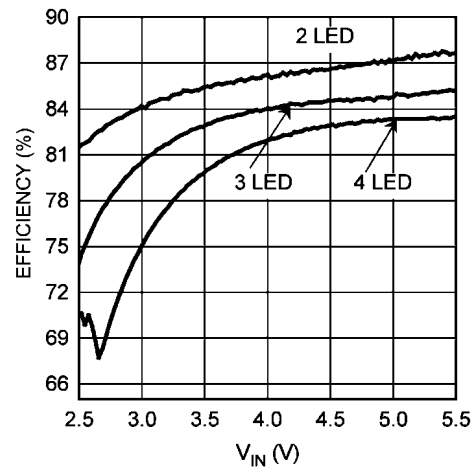

30004261

Peak Current Limit vs V_{IN}

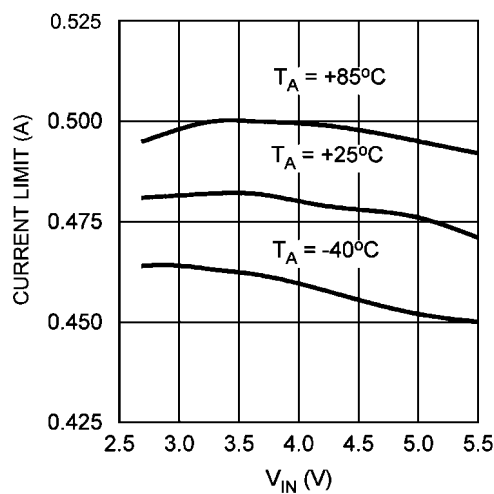

30004213

Switching Frequency vs V_{IN}

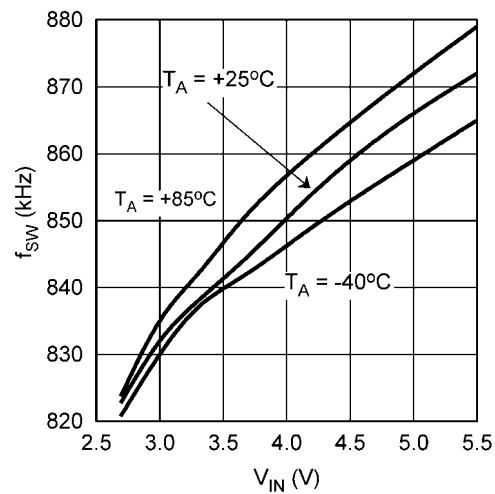

30004214

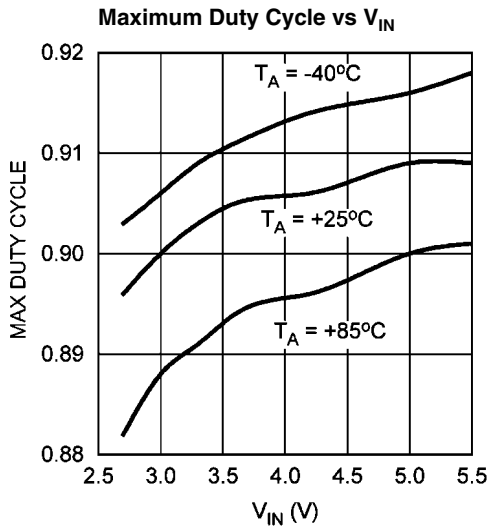

30004215

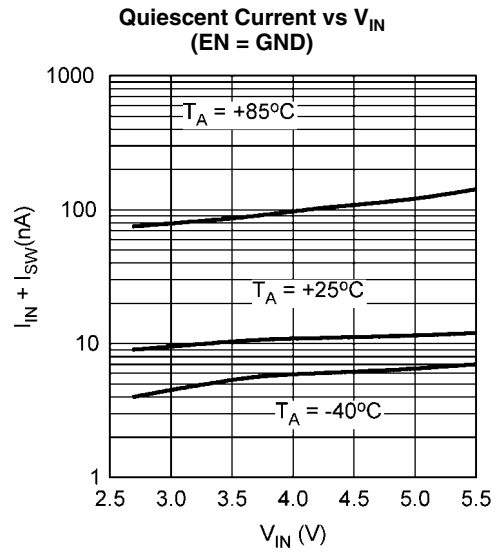

30004217

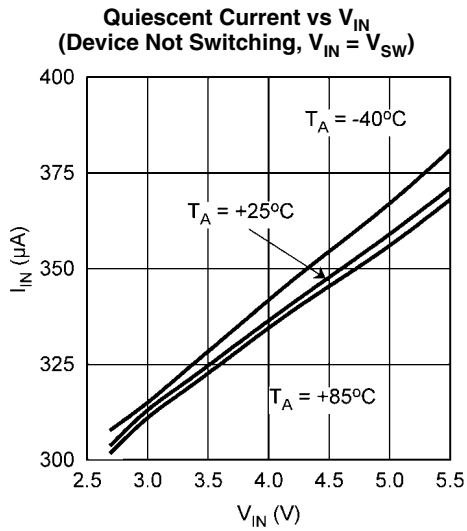

30004216

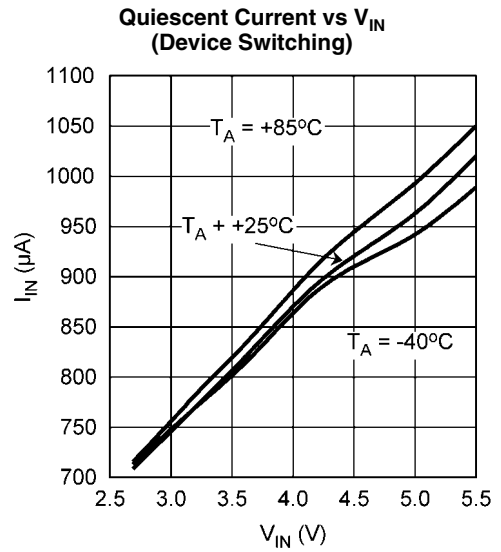

30004218

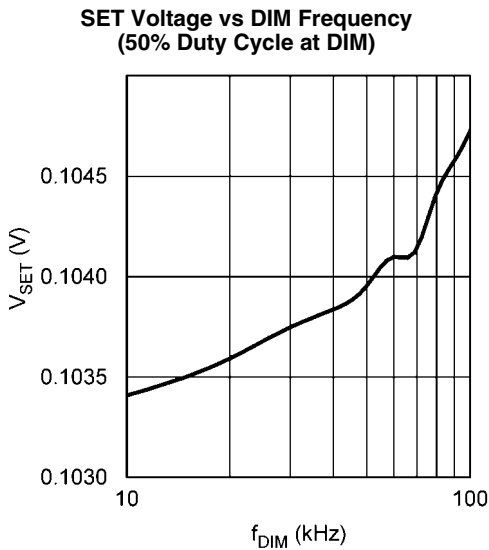

30004219

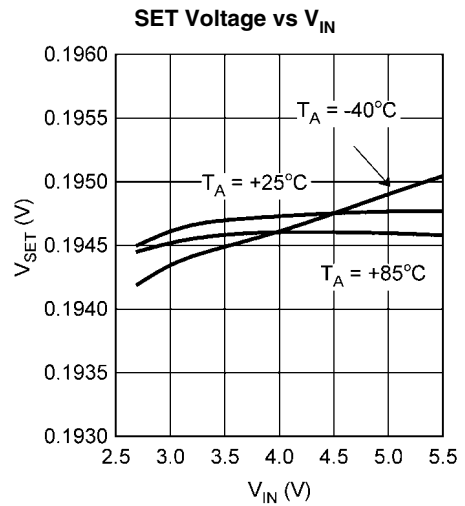

30004259

SET Voltage vs DIM Duty Cycle

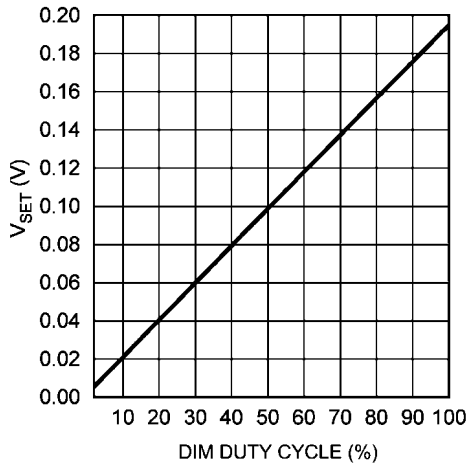

30004262

NFET On-Resistance vs V_{IN}
(I_{SW} = 250mA)

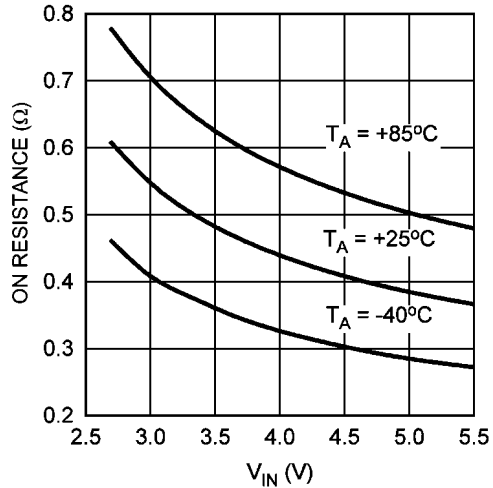

30004224

PFET On-Resistance vs Temperature
(V_{SW} = 10.4V, V_{OUT} = 10V)

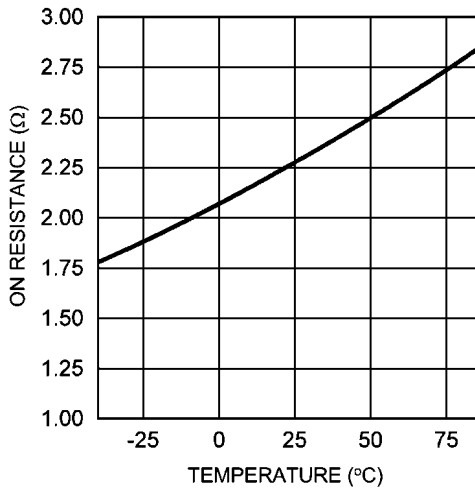

30004225

Over Voltage Limit vs V_{IN}
(V_{OUT} Rising)

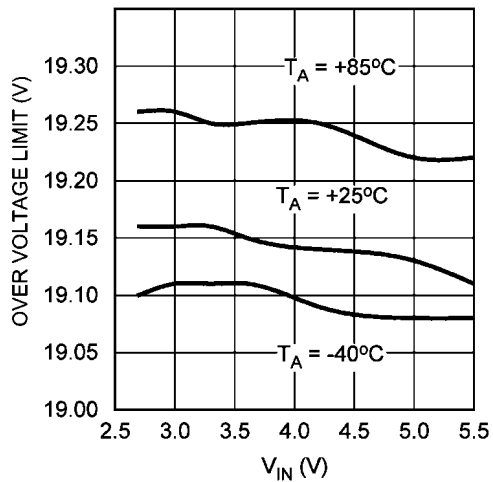

30004227

Over Voltage Limit vs V_{IN} (V_{OUT} Falling)

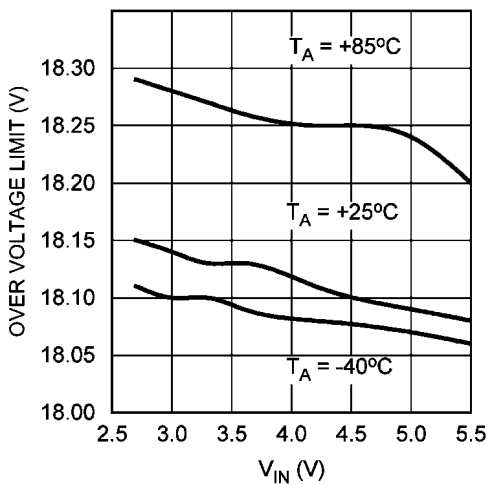

30004228

Start-Up Waveform

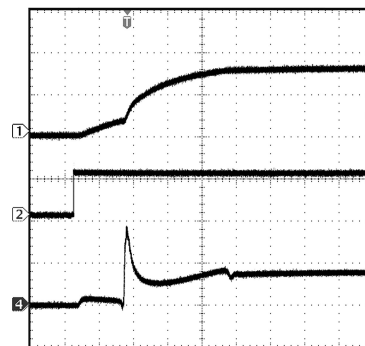

30004257

4 LEDs, I_{LED} = 30mA, V_{IN} = 3.6V
 Channel 1: V_{OUT} (10V/div)
 Channel 2: EN (2V/div)
 Channel 4: I_{IN} (200mA/div)
 Time Base: 100μs/div

Over-Voltage Protection Function

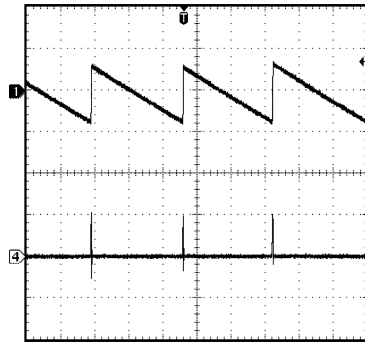

30004237

$V_{IN} = 3.6V$, $V_{OUT} = 18.86V$
 Channel 1: V_{OUT} (1V/div)
 Channel 4: I_{IN} (500mA/div)
 Time Base: 400 μ s/div

Line-Step Response

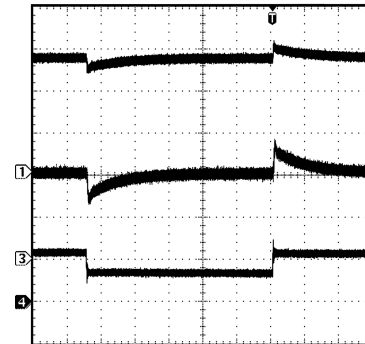

30004255

$V_{IN} = 3.6V$, 4 LEDs
 Channel 1: V_{OUT} (AC Copuled, 1V/div)
 Channel 3: V_{IN} (AC Coupled, 500mV/div)
 Channel 4: I_{LED} (DC Coupled, 5mA/div)
 Time Base: 200 μ s/div

Output Short-Circuit Response

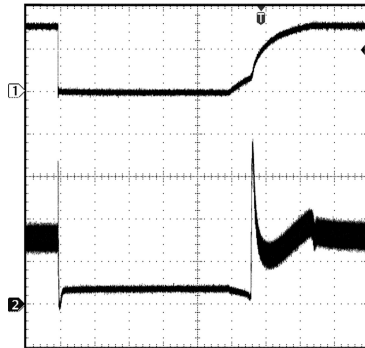

30004256

$V_{IN} = 3.6V$, $I_{LED} = 30mA$
 Channel 1: V_{OUT} (10V/div)
 Channel 2: I_{IN} (100mA/div)
 Time Base: 200 μ s/div

Typical Operating Waveforms (DIM High)

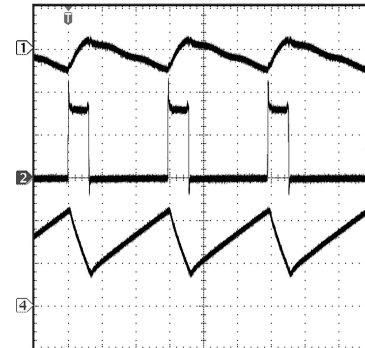

30004229

$V_{IN} = 3.6V$, 4 LEDs, $I_{LED} = 30mA$, $V_{OUT} = 15.8V$
 Channel 1: V_{OUT} (AC Coupled, 100mV/div)
 Channel 2: V_{SW} (DC Coupled, 10V/div)
 Channel 4: I_L (DC Coupled, 100mA/div)
 Time Base: 400ns/div

Typical Operating Waveforms (DIM With 20kHz Square Wave)

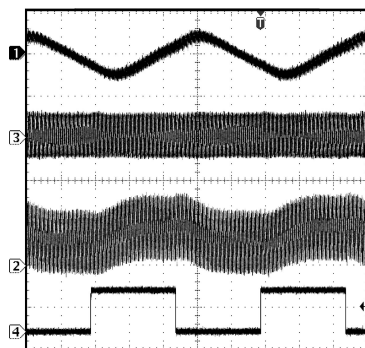

30004230

$V_{IN} = 3.6V$, 4 LEDs, $I_{LED} = 15mA$
 Channel 1: V_{OUT} (AC Coupled, 200mV/div)
 Channel 3: V_{IN} (AC Coupled, 100mV/div)
 Channel 2: I_L (DC Coupled, 100mA/div)
 Channel 4: DIM (DC Coupled, 2V/div)
 Time Base: 10 μ s/div

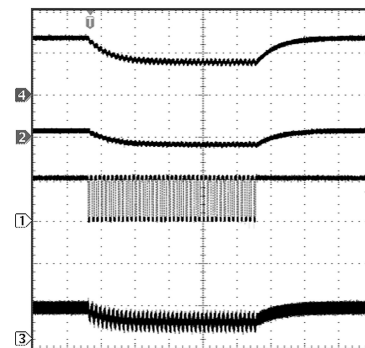
DIM Operation (I_{LED} changing from 30mA to 15mA)

30004238

$V_{IN} = 3.6V$
 Channel 4: I_{LED} (DC Coupled, 10mA/div)
 Channel 2: V_{OUT} (AC Coupled, 2V/div)
 Channel 1: DIM (DC Coupled, 2V/div, 20kHz, 50% duty cycle)
 Channel 3: I_{IN} (DC Coupled, 200mA/div)
 Time Base: 400 μ s/div

Operation

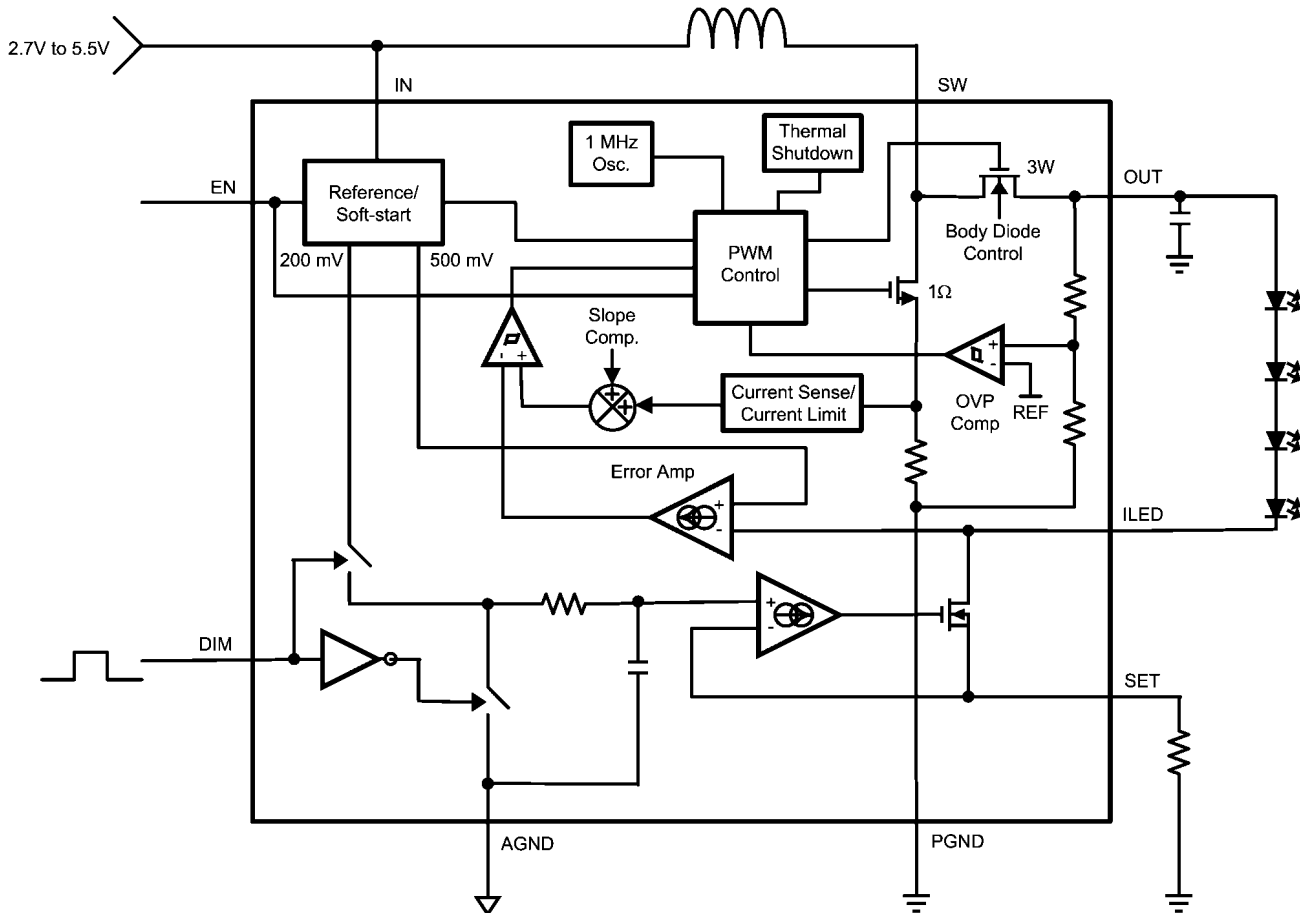

30004203

FIGURE 1. LM3508 Block Diagram

The LM3508 utilizes a synchronous step-up current mode PWM controller and a regulated current sink to provide a highly efficient and accurate LED current for white LED bias. The internal synchronous rectifier increases efficiency and eliminates the need for an external diode. Additionally, internal compensation eliminates the need for external compensation components resulting in a compact overall solution.

Figure 1 shows the detailed block diagram of the LM3508. The output of the boost converter (OUT) provides power to the series string of white LED's connected between OUT and ILED. The boost converter regulates the voltage at ILED to 500mV. This voltage is then used to power the internal current source whose output is at SET.

The first stage of the LM3508 consists of the synchronous boost converter. Operation is as follows: At the start of each switching cycle the oscillator sets the PWM controller. The controller turns the low side (NMOS) switch on and the synchronous rectifier (PMOS) switch off. During this time current ramps up in the inductor while the output capacitor supplies the current to the LED's. The error signal at the output of the error amplifier is compared against the sensed inductor current. When the sensed inductor current equals the error signal, or when the maximum duty cycle is reached, the NMOS switch turns off and the PMOS switch turns on. When the PMOS turns on, the inductor current ramps down, restoring energy to the output capacitor and supplying current to the

LED's. At the end of the clock period the PWM controller is again set and the process repeats itself. This action regulates ILED to 500mV.

The second stage of the LM3508 consists of an internal current source powered by the ILED voltage and providing a regulated current at SET. The regulated LED current is set by connecting an external resistor from SET to PGND. V_{SET} is adjusted from 0 to 200mV by applying a PWM signal of up to typically 100kHz at DIM (see Typical Performance Characteristic of SET voltage vs DIM frequency). The PWM signal at DIM modulates the internal 200mV reference and applies it to an internal RC filter resulting in an adjustable SET voltage and thus an adjustable LED current.

Start-Up

The LM3508 features a soft-start to prevent large inrush currents during start-up that can cause excessive voltage ripple on VIN. During start-up the average input current is ramped up at a controlled rate. For the typical application circuit, driving 4LED's from a 3.6V lithium battery at 30mA, when EN is driven high the average input current ramps from zero to 160mA in 470μs. See plot of Soft Start functionality in the Typical Performance Characteristics.

DIM Operation

DIM is the input to the gate of an internal switch that accepts a logic level PWM waveform and modulates the internal 200mV reference through an internal RC filter. This forces the current source regulation point (V_{SET}) to vary by the duty cycle (D) of the DIM waveform making $I_{LED} = D \times 200\text{mV} / R_{SET}$. The cutoff frequency for the filter is approximately 500Hz. DIM frequencies higher than 100kHz cause the LED current to drastically deviate from their nominal set points. The graphs of SET voltage vs DIM frequency, SET voltage vs V_{IN} and SET voltage vs DIM duty cycle (see Typical Performance Characteristics) show the typical variation of the current source set point voltage.

Enable Input and Output Isolation

Driving EN high turns the device on while driving EN low places the LM3508 in shutdown. In shutdown the supply current reduces to less than 1 μ A, the internal synchronous PFET turns off as well as the current source (N2 in figure 1). This completely isolates the output from the input and prevents leakage current from flowing through the LED's. In shutdown the leakage current into SW and IN is typically 400nA. EN has an internal 383k Ω pull-down to PGND.

Peak Current Limit/Maximum Output Current

The LM3508 boost converter provides a peak current limit. When the peak inductor current reaches the peak current limit the duty cycle is terminated. This results in a limit on the maximum output power and thus the maximum output current the LM3508 can deliver. Calculate the maximum LED current as a function of V_{IN} , V_{OUT} , L and I_{PEAK} as:

$$I_{LED_MAX} = \frac{(I_{PEAK} - \Delta I_L) \times \eta \times V_{IN}}{V_{OUT}}$$

$$\text{where } \Delta I_L = \frac{V_{IN} \times (V_{OUT} - V_{IN})}{2 \times f_{SW} \times L \times V_{OUT}}$$

and $f_{SW} = 850\text{kHz}$. Efficiency and I_{PEAK} can be found in the efficiency and I_{PEAK} curves in the Typical Performance Characteristics.

Output Current Accuracy

The LM3508 provides highly accurate output current regulation of $\pm 5\%$ over the 3V to 5.5V input voltage range. Accuracy depends on various key factors. Among these are; the tolerance of R_{SET} , the frequency at DIM (f_{DIM}), and the errors internal to the LM3508 controller and current sink. For best accuracy, use a 1% resistor for R_{SET} and keep f_{DIM} between 1kHz and 100kHz. Refer to the Typical Performance Characteristics for V_{SET} vs V_{IN} , V_{SET} vs f_{DIM} , and V_{SET} vs DIM duty cycle.

Voltage Head Room at ILED

If the LED current is increased to a point where the peak inductor current is reached, the boost converter's on-time is terminated until the next switching cycle. If the LED current is further increased the 500mV regulated voltage at ILED begins to drop. When V_{ILED} drops below the current sink headroom voltage ($V_{HR} = 400\text{mV}$ typ.) the current sink FET (see N2 in

figure 1) will be fully on, appearing as a 5 Ω resistor between ILED and SET.

Output Short Circuit Protection

The LM3508 provides a short circuit protection that limits the output current if OUT is shorted to PGND. During a short at OUT when V_{OUT} falls to below $V_{IN} \times 0.93$, switching will stop. The PMOS will turn into a current source and limit the output current to 35mA. The LM3508 can survive with a continuous short at the output. The threshold for OUT recovering from a short circuit condition is typically $V_{IN} \times 0.95$.

Output Over-Voltage Protection

When the load at the output of the LM3508 goes high impedance the boost converter will raise V_{OUT} to try and maintain the programmed LED current. To prevent over-voltage conditions that can damage output capacitors and/or the device, the LM3508 will clamp the output at a maximum of 21.8V. This allows for the use of 25V output capacitors available in a tiny 1.6mm \times 0.8mm case size.

During output open circuit conditions when the output voltage rises to the over voltage protection threshold ($V_{OVP} = 19.8\text{V}$ typical) the OVP circuitry will shut off both the NMOS and PMOS switches. When the output voltage drops below 18.6V (typically) the converter will begin switching again. If the device remains in an over voltage condition the cycle will be repeated resulting in a pulsed condition at the output. See waveform for OVP condition in the Typical Performance Characteristics.

Light Load Operation

During light load conditions when the inductor current reaches zero before the end of the switching period, the PFET will turn off, disconnecting OUT from SW and forcing the converter into discontinuous conduction. At the beginning of the next switching cycle, switching will resume. (see plot of discontinuous conduction mode in the Typical Performance Characteristics graphs).

Boost converters that operate in the discontinuous conduction mode with fixed input to output conversion ratios (V_{OUT}/V_{IN}) have load dependent duty cycles, resulting in shorter switch on-times as the load decreases. As the load is decreased the duty cycle will fall until the converter hits its minimum duty cycle (typically 15%). To prevent further decreases in the load current altering the V_{OUT}/V_{IN} ratio, the LM3508 will enter a pulsed skip mode. In pulse skip mode the device will only switch as necessary to keep the LED current in regulation.

Thermal Shutdown

The LM3508 provides a thermal shutdown feature. When the die temperature exceeds +150 $^{\circ}$ C the part will shutdown, turning off both the NMOS and PMOS FET's. The part will start-up again with a soft-start sequence when the die temperature falls below +115 $^{\circ}$ C.

Applications Information

Brightness Adjustment

A logic high at DIM forces SET to regulate to 200mV. Adjust the maximum LED current by picking R_{SET} (the resistor from SET to GND) such that:

$$I_{LED_MAX} = \frac{200 \text{ mV}}{R_{SET}}$$

Once I_{LED_MAX} is set, the LED current can be adjusted from I_{LED_MAX} down to I_{LED_MIN} by applying a logic level PWM signal to DIM. This results in:

$$I_{LED} = \frac{D \times 200 \text{ mV}}{R_{SET}}$$

where D is the duty cycle of the PWM pulse applied to DIM. The LM3508 can be brought out of shutdown while a signal is applied to DIM, allowing the device to turn on into a low LED current mode. A logic low at DIM will shut off the current source making ILED high impedance however, the boost converter continues to operate. Due to an offset voltage at SET (approximately +/-2mV) the LED's can faintly illuminate even with DIM pulled to GND. If zero LED current is required then pulling EN low will shutdown the current source causing the LED current to drop to zero. DIM has an internal 383kΩ pull down to PGND.

Input Capacitor Selection

Choosing the correct size and type of input capacitor helps minimize the input voltage ripple caused by the switching action of the LM3508's boost converter. For continuous inductor current operation the input voltage ripple is composed of 2 primary components, the capacitor discharge (delta V_Q) and the capacitor's equivalent series resistance (delta V_{ESR}). The ripple due to strictly to the capacitor discharge is:

$$\Delta V_Q = \frac{\Delta I_L \times D}{2 \times f_{SW} \times C_{IN}}$$

The ripple due to strictly to the capacitors ESR is:

$$\Delta V_{ESR} = 2 \times I_L \times R_{ESR}$$

$$\text{where } \Delta I_L = \frac{V_{IN} \times (V_{OUT} - V_{IN})}{2 \times f_{SW} \times L \times V_{OUT}}$$

In the typical application circuit, a 1μF ceramic input capacitor works well. Since the ESR in ceramic capacitors is typically less than 5mΩ and the capacitance value is usually small, the input voltage ripple is primarily due to the capacitive discharge. With larger value capacitors such as tantalum or aluminum electrolytic the ESR can be greater than 0.5Ω. In this case the input ripple will primarily be due to the ESR.

Output Capacitor Selection

In a boost converter such as the LM3508, during the on time, the inductor is disconnected from OUT forcing the output capacitor to supply the LED current. When the PMOS switch (synchronous rectifier) turns on the inductor energy supplies the LED current and restores charge to the output capacitor. This action causes a sag in the output voltage during the on time and a rise in the output voltage during the off time.

The LM3508's output capacitor is chosen to limit the output ripple to an acceptable level and to ensure the boost converter is stable. For proper operation use a 1μF ceramic output capacitor. Values of 2.2μF or 4.7μF can be used although start-up current and start-up time will be increased. As with the

input capacitor, the output voltage ripple is composed of two parts, the ripple due to capacitor discharge (delta V_Q) and the ripple due to the capacitors ESR (delta V_{ESR}). Most of the time the LM3508 will operate in continuous conduction mode. In this mode the ripple due to capacitor discharge is given by:

$$\Delta V_Q = \frac{I_{LED} \times (V_{OUT} - V_{IN})}{f_{SW} \times V_{OUT} \times C_{OUT}}$$

The output voltage ripple component due to the output capacitors ESR is found by:

$$\Delta V_{ESR} = R_{ESR} \times \left(\frac{I_{LED} \times V_{IN}}{V_{IN}} + \Delta I_L \right)$$

$$\text{where } \Delta I_L = \frac{V_{IN} \times (V_{OUT} - V_{IN})}{2 \times f_{SW} \times L \times V_{OUT}}$$

Table 1. Recommended Output Capacitor Manufacturers

Manufacturer	Part Number	Value	Case Size	Voltage Rating
Murata	GRM39X5	1μF	0603	25V
	R105K25 D539			
TDK	C1608X5 R1E105M	1μF	0603	25V

Inductor Selection

The LM3508 is designed to operate with 10μH to 22μH inductor's. When choosing the inductor ensure that the inductor's saturation current rating is greater than

$$\frac{I_{LED}}{\eta} \times \frac{V_{OUT}}{V_{IN}} + \Delta I_L$$

$$\text{where } \Delta I_L = \frac{V_{IN} \times (V_{OUT} - V_{IN})}{2 \times f_{SW} \times L \times V_{OUT}}$$

Additionally, the inductor's value should be large enough such that at the maximum LED current, the peak inductor current is less than the LM3508's peak switch current limit. This is done by choosing L such that

$$L > \frac{V_{IN} \times (V_{OUT} - V_{IN})}{2 \times f_{SW} \times L \times V_{OUT} \times \left(I_{PEAK} - \frac{I_{LED_MAX} \times V_{OUT}}{\eta \times V_{IN}} \right)}$$

Values for I_{PEAK} and efficiency can be found in the plot of peak current limit vs. V_{IN} in the Typical Performance Characteristics graphs.

Table 2. Recommended Inductor Manufacturers

Manufacturer	L	Part Number	Size	Saturation Current
TDK	22 μ H	VLF3010 AT-220M R33	2.6mm \times 2.8mm \times 1mm	330mA
TDK	22 μ H	VLF3012 AT-220M R33	2.6mm \times 2.8mm \times 1.2mm	330mA
Toko	22 μ H	D3313FB (1036FB-220M)	3.3mm \times 3.3mm \times 1.3mm	350mA

Layout Considerations

Proper layout is essential for stable, jitter free operation, and good efficiency. Follow these steps to ensure a good layout.

- 1, Use a separate ground plane for power ground (PGND) and analog ground (AGND).
- 2, Keep high current paths such as SW and PGND connections short.
- 3, Connect the return terminals for the input capacitor and the output capacitor together at a single point as close as possible to PGND.
- 4, Connect PGND and AGND together as close as possible to the IC. Do not connect them together anywhere else.
- 5, Connect the input capacitor (C_{IN}) as close as possible to IN.
- 6, Connect the output capacitor (C_{OUT}) as close as possible to OUT.
- 7, Connect the positive terminal of R_{SET} as close as possible to ILED and the negative terminal as close as possible to PGND. This ensures accurate current programming.

Physical Dimensions inches (millimeters) unless otherwise noted

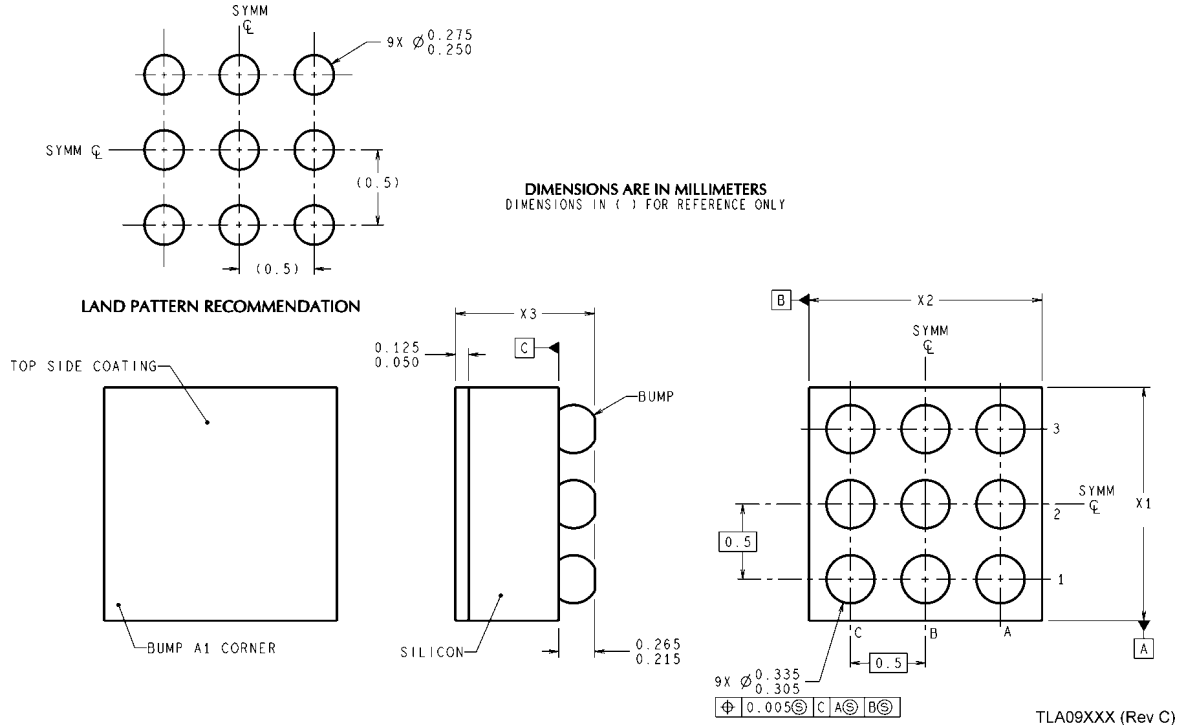

9-Bump Micro SMD Package (TL09AAA)
For Ordering, Refer to Ordering Information Table
NS Package Number TLA09AAA
X1 = 1.514mm (\pm 0.03mm), X2 = 1.514mm (\pm 0.03mm), X3 = 0.6mm (\pm 0.075mm)

Notes

For more National Semiconductor product information and proven design tools, visit the following Web sites at:

Products		Design Support	
Amplifiers	www.national.com/amplifiers	WEBENCH	www.national.com/webench
Audio	www.national.com/audio	Analog University	www.national.com/AU
Clock Conditioners	www.national.com/timing	App Notes	www.national.com/appnotes
Data Converters	www.national.com/adc	Distributors	www.national.com/contacts
Displays	www.national.com/displays	Green Compliance	www.national.com/quality/green
Ethernet	www.national.com/ethernet	Packaging	www.national.com/packaging
Interface	www.national.com/interface	Quality and Reliability	www.national.com/quality
LVDS	www.national.com/lvds	Reference Designs	www.national.com/refdesigns
Power Management	www.national.com/power	Feedback	www.national.com/feedback
Switching Regulators	www.national.com/switchers		
LDOs	www.national.com/ldo		
LED Lighting	www.national.com/led		
PowerWise	www.national.com/powerwise		
Serial Digital Interface (SDI)	www.national.com/sdi		
Temperature Sensors	www.national.com/tempsensors		
Wireless (PLL/VCO)	www.national.com/wireless		

THE CONTENTS OF THIS DOCUMENT ARE PROVIDED IN CONNECTION WITH NATIONAL SEMICONDUCTOR CORPORATION ("NATIONAL") PRODUCTS. NATIONAL MAKES NO REPRESENTATIONS OR WARRANTIES WITH RESPECT TO THE ACCURACY OR COMPLETENESS OF THE CONTENTS OF THIS PUBLICATION AND RESERVES THE RIGHT TO MAKE CHANGES TO SPECIFICATIONS AND PRODUCT DESCRIPTIONS AT ANY TIME WITHOUT NOTICE. NO LICENSE, WHETHER EXPRESS, IMPLIED, ARISING BY ESTOPPEL OR OTHERWISE, TO ANY INTELLECTUAL PROPERTY RIGHTS IS GRANTED BY THIS DOCUMENT.

TESTING AND OTHER QUALITY CONTROLS ARE USED TO THE EXTENT NATIONAL DEEMS NECESSARY TO SUPPORT NATIONAL'S PRODUCT WARRANTY. EXCEPT WHERE MANDATED BY GOVERNMENT REQUIREMENTS, TESTING OF ALL PARAMETERS OF EACH PRODUCT IS NOT NECESSARILY PERFORMED. NATIONAL ASSUMES NO LIABILITY FOR APPLICATIONS ASSISTANCE OR BUYER PRODUCT DESIGN. BUYERS ARE RESPONSIBLE FOR THEIR PRODUCTS AND APPLICATIONS USING NATIONAL COMPONENTS. PRIOR TO USING OR DISTRIBUTING ANY PRODUCTS THAT INCLUDE NATIONAL COMPONENTS, BUYERS SHOULD PROVIDE ADEQUATE DESIGN, TESTING AND OPERATING SAFEGUARDS.

EXCEPT AS PROVIDED IN NATIONAL'S TERMS AND CONDITIONS OF SALE FOR SUCH PRODUCTS, NATIONAL ASSUMES NO LIABILITY WHATSOEVER, AND NATIONAL DISCLAIMS ANY EXPRESS OR IMPLIED WARRANTY RELATING TO THE SALE AND/OR USE OF NATIONAL PRODUCTS INCLUDING LIABILITY OR WARRANTIES RELATING TO FITNESS FOR A PARTICULAR PURPOSE, MERCHANTABILITY, OR INFRINGEMENT OF ANY PATENT, COPYRIGHT OR OTHER INTELLECTUAL PROPERTY RIGHT.

LIFE SUPPORT POLICY

NATIONAL'S PRODUCTS ARE NOT AUTHORIZED FOR USE AS CRITICAL COMPONENTS IN LIFE SUPPORT DEVICES OR SYSTEMS WITHOUT THE EXPRESS PRIOR WRITTEN APPROVAL OF THE CHIEF EXECUTIVE OFFICER AND GENERAL COUNSEL OF NATIONAL SEMICONDUCTOR CORPORATION. As used herein:

Life support devices or systems are devices which (a) are intended for surgical implant into the body, or (b) support or sustain life and whose failure to perform when properly used in accordance with instructions for use provided in the labeling can be reasonably expected to result in a significant injury to the user. A critical component is any component in a life support device or system whose failure to perform can be reasonably expected to cause the failure of the life support device or system or to affect its safety or effectiveness.

National Semiconductor and the National Semiconductor logo are registered trademarks of National Semiconductor Corporation. All other brand or product names may be trademarks or registered trademarks of their respective holders.

Copyright© 2008 National Semiconductor Corporation

For the most current product information visit us at www.national.com



**National Semiconductor
Americas Technical
Support Center**
Email:
new.feedback@nsc.com
Tel: 1-800-272-9959

**National Semiconductor Europe
Technical Support Center**
Email: europe.support@nsc.com
German Tel: +49 (0) 180 5010 771
English Tel: +44 (0) 870 850 4288

**National Semiconductor Asia
Pacific Technical Support Center**
Email: ap.support@nsc.com

**National Semiconductor Japan
Technical Support Center**
Email: jpn.feedback@nsc.com