

# LM2751

## Regulated 2X, 1.5X Switched Capacitor White LED Driver

### General Description

The LM2751 is a constant frequency switched capacitor charge pump with regulated output voltage options of 4.5V, and 5.0V. Over the input voltage range of 2.8V to 5.5V the LM2751 provides up to 150mA of output current and requires only four low-cost ceramic capacitors.

The LM2751 provides excellent efficiency without the use of an inductor by operating the charge pump in a gain of 3/2 or 2. The proper gain for maintaining regulation is chosen so that efficiency is maximized over the input voltage range.

LM2751 uses constant frequency pre-regulation to minimize conducted noise on the input and provide a predictable switching frequency. The switching frequency is programmable to 725kHz, 300kHz, 37kHz, or 9.5kHz.

LM2751 is available in a 10-pin Leadless Leadframe No-Pullback Package: LLP-10.

### Features

- Regulated Output Options: 4.5V, 5.0V
- Output Voltage Regulated within 3%
- Peak Efficiency Over 90%
- 150mA (4.5V) or 80mA (5.0V) Output Current Capability
- Input Voltage Range: 2.8V to 5.5V
- Low Input and Output Voltage Ripple
- <1µA Typical Shutdown Current
- Small Solution Size - NO INDUCTOR
- Programmable 725kHz, 300kHz, 37kHz, or 9.5kHz Switching Frequencies
- 10-pin LLP No-Pullback Package: 3mm x 3mm x 0.8mm

### Applications

- White LED Display Backlights
- White LED Keypad Backlights
- General Purpose 2x, 1.5x Regulated Charge Pump

### Typical Application Circuit

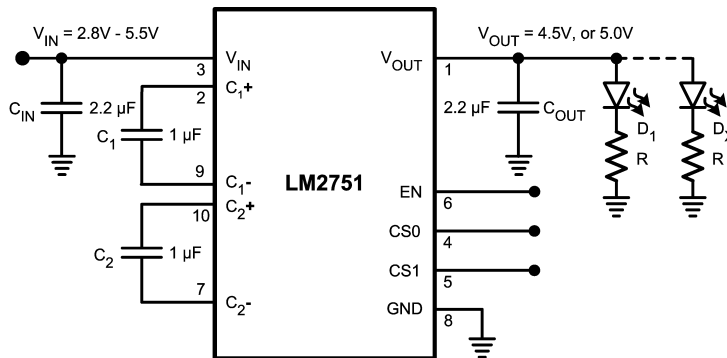

Capacitors: 1 µF - TDK C1608X7R1A105K  
2.2 µF - TDK C2012X5R1A225K

20112101

LM2751 2x/1.5x Efficiency vs. 2x Charge Pump Efficiency

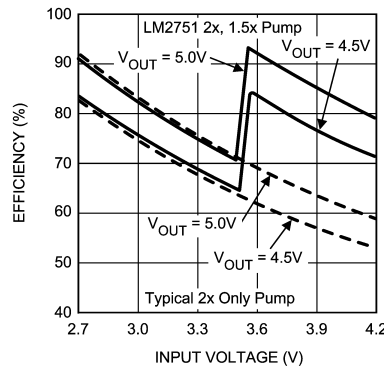

20112128

## Connection Diagram

10-pin Leadless Leadframe Package (LLP-10) No Pullback  
3mm x 3mm x 0.8mm  
NS Package Number SDA10A

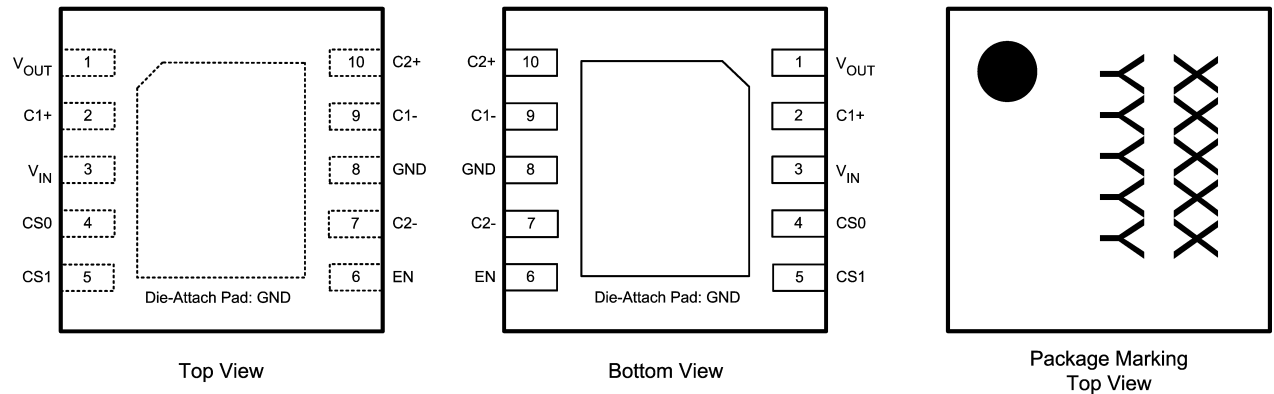

**Note:** The actual physical placement of the package marking will vary from part to part. The package marking placeholder "XXXXX" is a code for die traceability. "YYYYYY" identifies the device (part number, voltage option, etc.). See the Order Information table below for the device ID codes.

20112102

## Pin Descriptions

Pin #	Name	Description
1	$V_{OUT}$	Pre-Regulated Output.
2	$C1+$	Flying Capacitor C1 Connection.
3	$V_{IN}$	Input Supply Range: 2.8V to 5.5V.
4	$CS0$	Frequency Select Input 0.
5	$CS1$	Frequency Select Input 1.
6	$EN$	Enable Pin Logic Input.
7	$C2-$	Flying Capacitor C2 Connection.
8	$GND$	Ground.
9	$C1-$	Flying Capacitor C1 Connection.
10	$C2+$	Flying Capacitor C2 Connection.

## Ordering Information

Version	Voltage Option	Order Number	Package Marking	Supplied As Tape and Reel
A	5.0V	LM2751SD-A	XXXXX	1000 Units
A	5.0V	LM2751SDX-A	YYYYY = L145B	4500 Units
B	4.5V	LM2751SD-B	XXXXX	1000 Units
B	4.5V	LM2751SDX-B	YYYYY = L146B	4500 Units

**Absolute Maximum Ratings** (Notes 1, 2)

If Military/Aerospace specified devices are required, please contact the National Semiconductor Sales Office/Distributors for availability and specifications.

$V_{IN}$ Pin	-0.3V to 6.0V
EN, CS0, CS1 Pins	-0.3V to ( $V_{IN}+0.3$ ) w/ 6.0V max
Continuous Power Dissipation (Note 3)	Internally Limited
Junction Temperature ( $T_{J-MAX-ABS}$ )	150°C
Storage Temperature Range	-65°C to 150°C
Maximum Lead Temperature (Soldering, 10sec.)	265°C
ESD Rating (Note 4)	
Human-body model:	2kV
Machine model:	200V

**Operating Ratings** (Notes 1, 2)

Input Voltage Range	2.8V to 5.5V	
EN, CS0, CS1 Input Voltage Range	0V to $V_{IN}$	
Junction Temperature ( $T_J$ ) Range	-40°C to 115°C	
Ambient Temperature ( $T_A$ ) Range	-40°C to 85°C	
(Note 5)		
Recommended Maximum Load Current		
Version	Freq. = 725kHz	150mA
B	Freq. = 300kHz	120mA
	Freq. = 37kHz	40mA
	Freq. = 9.5kHz	10mA
Version	Freq. = 725kHz	80mA
A	Freq. = 300kHz	60mA
	Freq. = 37kHz	16mA
	Freq. = 9.5kHz	4mA

**Thermal Properties**

Junction-to-Ambient Thermal Resistance, LLP-10	55°C/W
Package ( $\theta_{JA}$ ) (Note 6)	

**Electrical Characteristics** (Notes 2, 7)

Limits in standard typeface are for  $T_A = 25^\circ\text{C}$ . Limits in **boldface** type apply over the full operating ambient temperature range (-40°C ≤  $T_A$  ≤ +85°C). Unless otherwise noted, specifications apply to the LM2751 Typical Application Circuit (pg. 1) with:  $V_{IN} = 3.6\text{V}$ ,  $V(EN) = V_{IN}$ ,  $CS0 = CS1 = V_{IN}$ ,  $C_1 = C_2 = 1.0\mu\text{F}$ ,  $C_{IN} = C_{OUT} = 2.2\mu\text{F}$  (Note 8).

Symbol	Parameter	Conditions	Min	Typ	Max	Units
$V_{OUT}$	Output Voltage	Version A, $2.8\text{V} \leq V_{IN} \leq 5.5\text{V}$ , Freq. = 300kHz, 725kHz, $T_A = 25^\circ\text{C}$ $I_{OUT} = 0$ to 60mA	4.850 (-3%)	5.0	5.150 (+3%)	V
		Version A, $2.8\text{V} \leq V_{IN} \leq 5.5\text{V}$ , Freq. = 300kHz, $I_{OUT} = 0$ to 60mA Freq. = 725kHz, $I_{OUT} = 0$ to 80mA	<b>4.775</b> <b>(-4.5%)</b>		<b>5.225</b> <b>(+4.5%)</b>	
		Version B, $2.8\text{V} \leq V_{IN} \leq 5.5\text{V}$ , Freq. = 300kHz, 725kHz, $T_A = 25^\circ\text{C}$ $I_{OUT} = 0$ to 120mA	4.343 (-3.5%)	4.5	4.658 (+3.5%)	
		Version B, $2.8\text{V} \leq V_{IN} \leq 5.5\text{V}$ , Freq. = 300kHz, $I_{OUT} = 0$ to 120mA Freq. = 725kHz, $I_{OUT} = 0$ to 150mA	<b>4.275</b> <b>(-5%)</b>		<b>4.725</b> <b>(+5%)</b>	
$V_R$	Output Ripple	$2.8\text{V} \leq V_{IN} \leq 5.5\text{V}$ $I_{OUT} = 60\text{mA}$		8		mV
$I_Q$	Quiescent Current	Freq. = 9.5kHz, $I_{OUT} = 0\text{mA}$ , $V_{IN} = 3.7\text{V}$		425	<b>600</b>	$\mu\text{A}$
		Freq. = 37kHz, $I_{OUT} = 0\text{mA}$ , $V_{IN} = 3.7\text{V}$		450	<b>640</b>	
		Freq. = 300kHz, $I_{OUT} = 0\text{mA}$ , $V_{IN} = 3.7\text{V}$		700	<b>900</b>	
		Freq. = 725kHz, $I_{OUT} = 0\text{mA}$ , $V_{IN} = 3.7\text{V}$		1000	<b>1500</b>	
$I_{SD}$	Shutdown Supply Current	$V(EN) = 0\text{V}$		0.77	1.3	$\mu\text{A}$
		$V(EN) = 0\text{V}$ , $T_A = 85^\circ\text{C}$		1.0		
E	Efficiency	$I_{OUT} = 80\text{mA}$ (Version A, 5.0V) Freq. = 300kHz, 725kHz		92		%
		$I_{OUT} = 150\text{mA}$ (Version B, 4.5V) Freq. = 300kHz, 725kHz		83		

## Electrical Characteristics (Notes 2, 7) (Continued)

Limits in standard typeface are for  $T_A = 25^\circ\text{C}$ . Limits in **boldface** type apply over the full operating ambient temperature range ( $-40^\circ\text{C} \leq T_A \leq +85^\circ\text{C}$ ). Unless otherwise noted, specifications apply to the LM2751 Typical Application Circuit (pg. 1) with:  $V_{IN} = 3.6\text{V}$ ,  $V(\text{EN}) = V_{IN}$ ,  $\text{CS0} = \text{CS1} = V_{IN}$ ,  $C_1 = C_2 = 1.0\mu\text{F}$ ,  $C_{IN} = C_{OUT} = 2.2\mu\text{F}$  (Note 8).

Symbol	Parameter	Conditions	Min	Typ	Max	Units
fsw	Switching Frequency	CS0 = High, CS1 = Low $2.8\text{V} \leq V_{IN} \leq 5.5\text{V}$	<b>6.7</b> <b>(-30%)</b>	9.5	<b>12.3</b> <b>(+30%)</b>	kHz
		CS0 = Low, CS1 = Low $2.8\text{V} \leq V_{IN} \leq 5.5\text{V}$	<b>26</b> <b>(-30%)</b>	37	<b>48</b> <b>(+30%)</b>	
		CS0 = Low, CS1 = High $2.8\text{V} \leq V_{IN} \leq 5.5\text{V}$	<b>210</b> <b>(-30%)</b>	300	<b>390</b> <b>(+30%)</b>	
		CS0 = High, CS1 = High $2.8\text{V} \leq V_{IN} \leq 5.5\text{V}$	<b>508</b> <b>(-30%)</b>	725	<b>942</b> <b>(+30%)</b>	
$V_{IH}$	Logic Input High	Input Pins: EN, CS0, CS1 $2.8\text{V} \leq V_{IN} \leq 5.5\text{V}$	<b>1.00</b>		$V_{IN}$	V
$V_{IL}$	Logic Input Low	Input Pins: EN, CS0, CS1 $2.8\text{V} \leq V_{IN} \leq 5.5\text{V}$	<b>0</b>		<b>.30</b>	V
$I_{IH}$	Logic Input High Current	Input Pins: CS0, CS1 $V(\text{CSx}) = 1.8\text{V}$		10		nA
		Input Pin: EN $V(\text{EN}) = 1.8\text{V}$ (Note 9)		2		$\mu\text{A}$
$I_{IL}$	Logic Input Low Current	Input Pins: EN, CS0, CS1 $V(\text{EN}, \text{CSx}) = 0\text{V}$		10		nA
$V_G$	Gain Transition Voltage (Version A, B)	1.5X to 2X		3.50		V
		2X to 1.5X		3.58		
		Hysteresis	<b>40</b>	80	<b>150</b>	mV
$I_{SC}$	Short Circuit Output Current	$V_{OUT} = 0\text{V}$		250		mA
$t_{ON}$	$V_{OUT}$ Turn-On Time (Note 10)			300		$\mu\text{s}$

**Note 1:** Absolute Maximum Ratings indicate limits beyond which damage to the component may occur. Operating Ratings are conditions under which operation of the device is guaranteed. Operating Ratings do not imply guaranteed performance limits. For guaranteed performance limits and associated test conditions, see the Electrical Characteristics tables.

**Note 2:** All voltages are with respect to the potential at the GND pin.

**Note 3:** Internal thermal shutdown circuitry protects the device from permanent damage. Thermal shutdown engages at  $T_J = 150^\circ\text{C}$  (typ.) and disengages at  $T_J = 140^\circ\text{C}$  (typ.).

**Note 4:** The Human body model is a 100 pF capacitor discharged through a 1.5k $\Omega$  resistor into each pin. The machine model is a 200pF capacitor discharged directly into each pin. MIL-STD-883 3015.7

**Note 5:** In applications where high power dissipation and/or poor package thermal resistance is present, the maximum ambient temperature may have to be derated. Maximum ambient temperature ( $T_{A-MAX}$ ) is dependent on the maximum operation junction temperature ( $T_{J-MAX-OP} = 115^\circ\text{C}$ ), the maximum power dissipation of the device in the application ( $P_{D-MAX}$ ), and the junction-to ambient thermal resistance of the part/package in the application ( $\theta_{JA}$ ), as given by the following equation:  $T_{A-MAX} = T_{J-MAX-OP} - (\theta_{JA} \times P_{D-MAX})$ .

**Note 6:** Junction-to-ambient thermal resistance ( $\theta_{JA}$ ) is taken from a thermal modeling result, performed under the conditions and guidelines set forth in the JEDEC standard JESD51-7. The test board is a 4 layer FR-4 board measuring 102mm x 76mm x 1.6mm with a 2 x 1 array of thermal vias. The ground plane on the board is 50mm x 50mm. Thickness of copper layers are 36 $\mu\text{m}$ /18 $\mu\text{m}$ /18 $\mu\text{m}$ /36 $\mu\text{m}$  (1.5oz/1oz/1oz/1.5oz). Ambient temperature in simulation is 22 $^\circ\text{C}$ , still air. Power dissipation is 1W.

The value of  $\theta_{JA}$  of the LM2751 in LLP-10 could fall in a range as wide as 50 $^\circ\text{C}/\text{W}$  to 150 $^\circ\text{C}/\text{W}$  (if not wider), depending on PWB material, layout, and environmental conditions. In applications where high maximum power dissipation exists (high  $V_{IN}$ , high  $I_{OUT}$ ), special care must be paid to thermal dissipation issues. For more information on these topics, please refer to **Application Note 1187: Leadless Leadframe Package (LLP)** and the **Power Efficiency and Power Dissipation** section of this datasheet.

**Note 7:** Min and Max limits are guaranteed by design, test, or statistical analysis. Typical numbers are not guaranteed, but represent the most likely norm.

**Note 8:**  $C_{IN}$ ,  $C_{OUT}$ ,  $C_1$ , and  $C_2$ : Low-ESR Surface-Mount Ceramic Capacitors (MLCCs) used in setting electrical characteristics.

**Note 9:** EN Logic Input High Current ( $I_{IH}$ ) is due to a 1M $\Omega$ (typ.) pull-down resistor connected internally between the EN pin and GND.

**Note 10:** Turn-on time is measured from when the EN signal is pulled high until the output voltage on  $V_{OUT}$  crosses 90% of its final value.

## Block Diagram

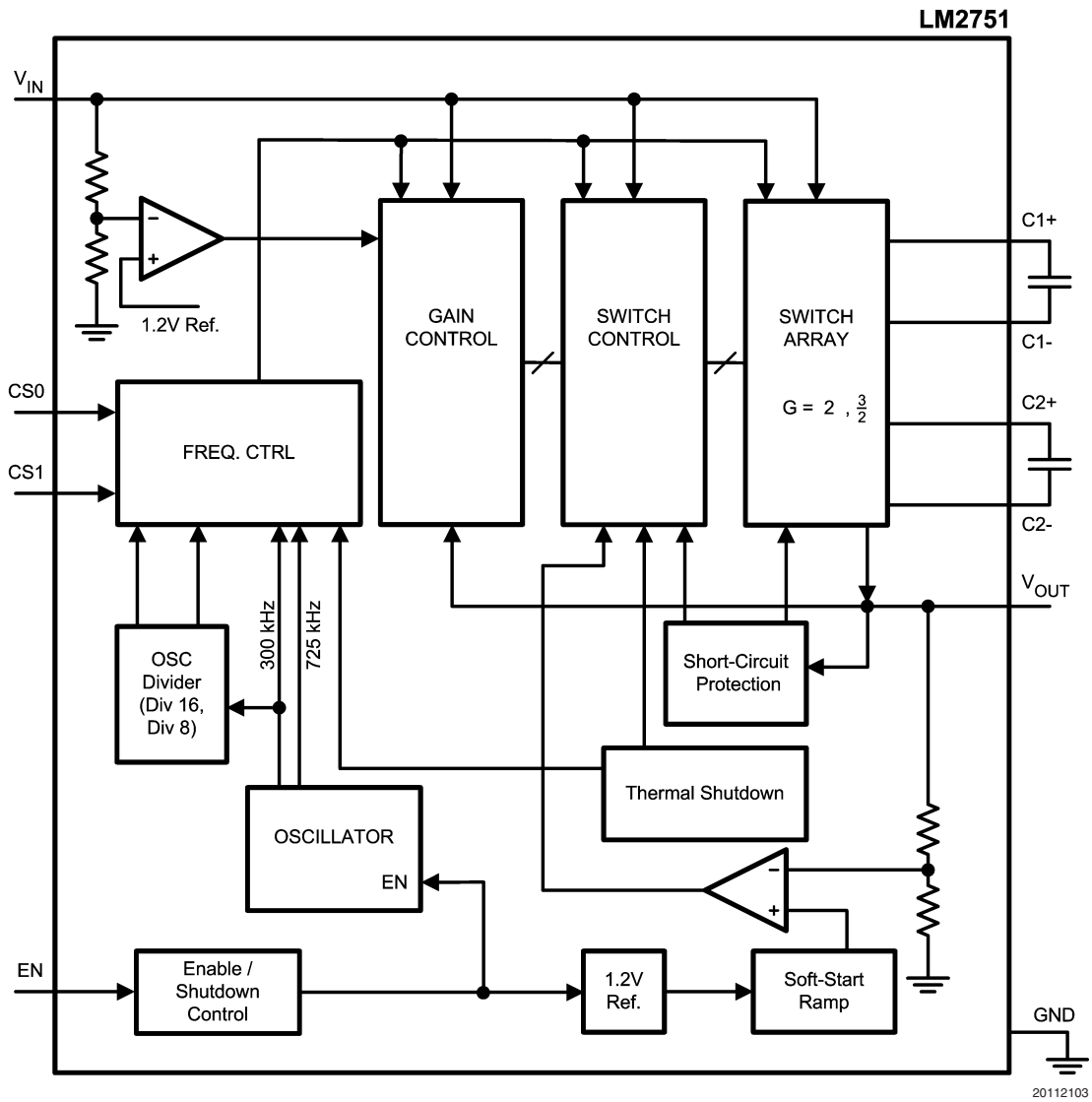

### Typical Performance Characteristics

Unless otherwise specified:  $T_A = 25^\circ\text{C}$ ,  $V_{IN} = 3.6\text{V}$ ,  $CS0 =$

$CS1 = V_{IN}$ ,  $V(EN) = V_{IN}$ ,  $C_{IN} = C_{OUT} = 2.2\mu\text{F}$ ,  $C_1 = C_2 = 1\mu\text{F}$ .

**Output Voltage vs. Output Current, Version A (5V), 300kHz**

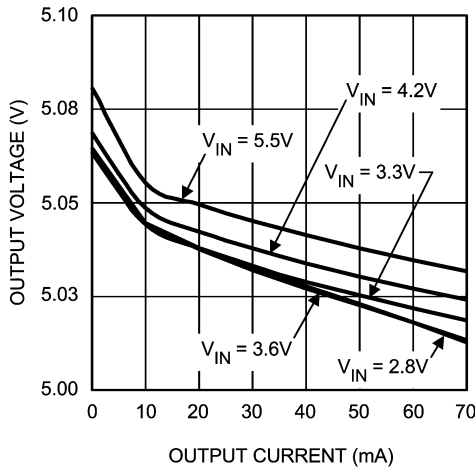

20112110

**Output Voltage vs. Output Current, Version B (4.5V), 300kHz**

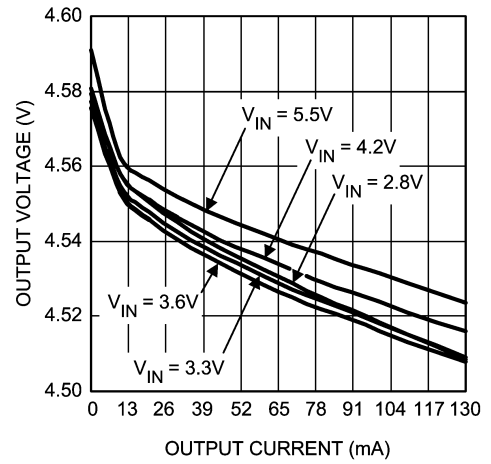

20112116

**Output Voltage vs. Output Current, Version A (5V), 725kHz**

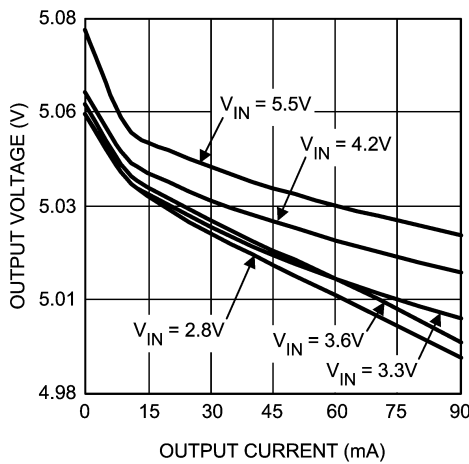

20112111

**Output Voltage vs. Output Current, Version B (4.5V), 725kHz**

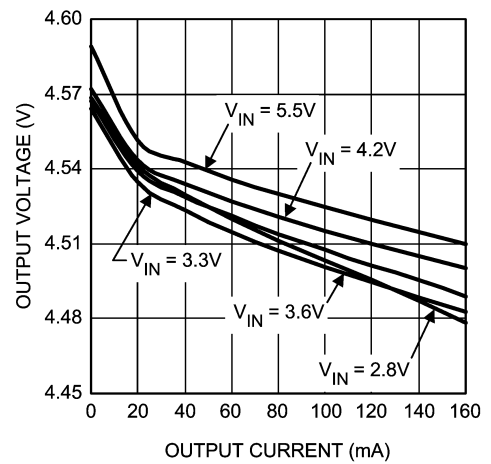

20112117

**Input Current vs. Input Voltage, Version A (5V)**

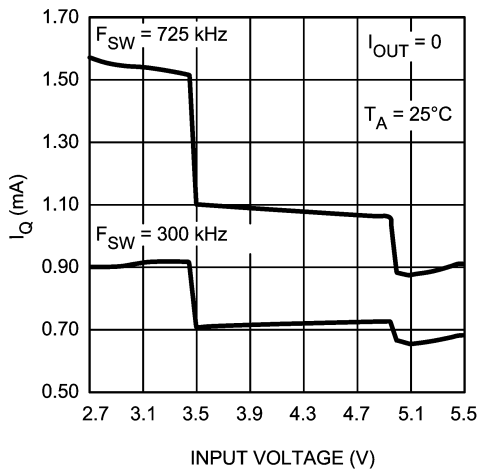

20112115

**Input Current vs. Input Voltage, Version B (4.5V)**

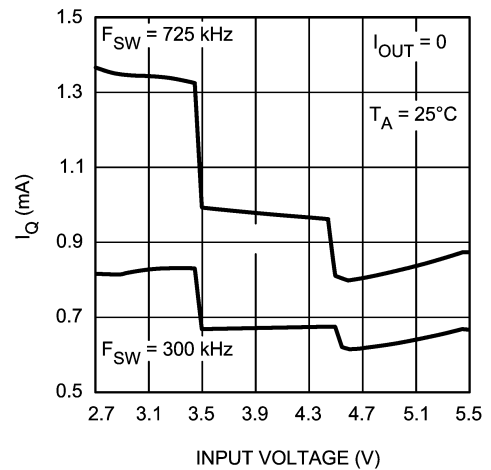

20112121

**Typical Performance Characteristics** Unless otherwise specified:  $T_A = 25^\circ\text{C}$ ,  $V_{IN} = 3.6\text{V}$ ,  $CS0 = CS1 = V_{IN}$ ,  $V(EN) = V_{IN}$ ,  $C_{IN} = C_{OUT} = 2.2\mu\text{F}$ ,  $C_1 = C_2 = 1\mu\text{F}$ . (Continued)

**Output Voltage vs. Input Voltage, Version A (5V), 300kHz**

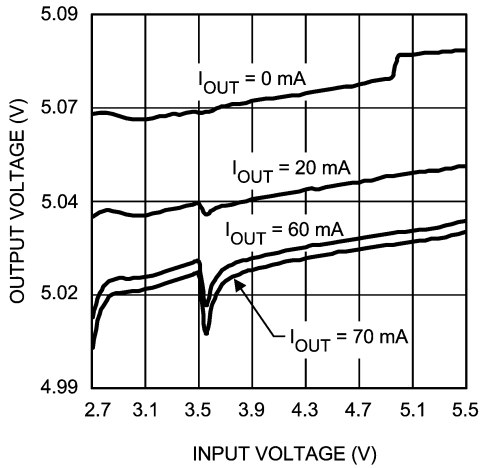

20112112

**Output Voltage vs. Input Voltage, Version B (4.5V), 300kHz**

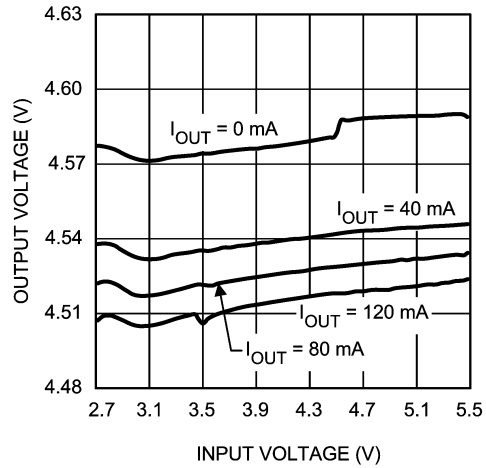

20112118

**Output Voltage vs. Input Voltage, Version A (5V), 725kHz**

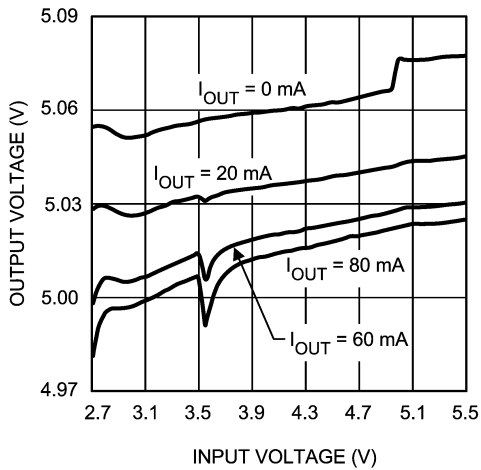

20112113

**Output Voltage vs. Input Voltage, Version B (4.5V), 725kHz**

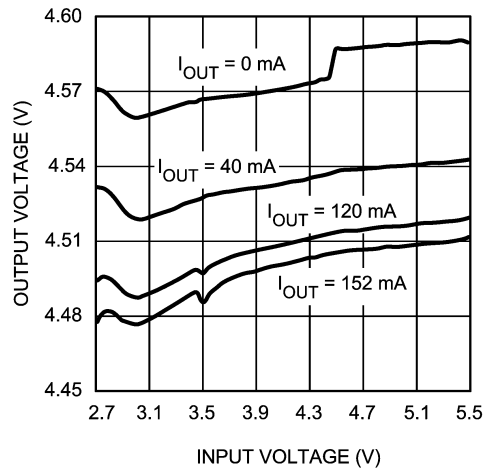

20112119

**Efficiency vs. Input Voltage, Version A (5V)**

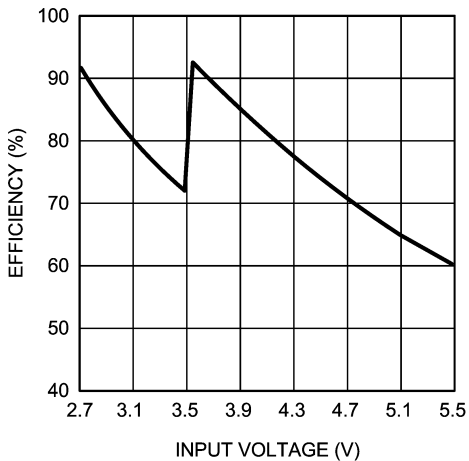

20112114

**Efficiency vs. Input Voltage, Version B (4.5V)**

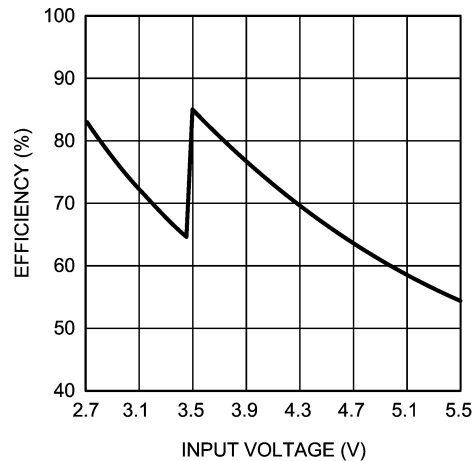

20112120

**Typical Performance Characteristics** Unless otherwise specified:  $T_A = 25^\circ\text{C}$ ,  $V_{IN} = 3.6\text{V}$ ,  $CS0 = CS1 = V_{IN}$ ,  $V(EN) = V_{IN}$ ,  $C_{IN} = C_{OUT} = 2.2\mu\text{F}$ ,  $C_1 = C_2 = 1\mu\text{F}$ . (Continued)

**Output Voltage Ripple vs. Input Voltage**  
Version B (4.5V), Load = 120mA

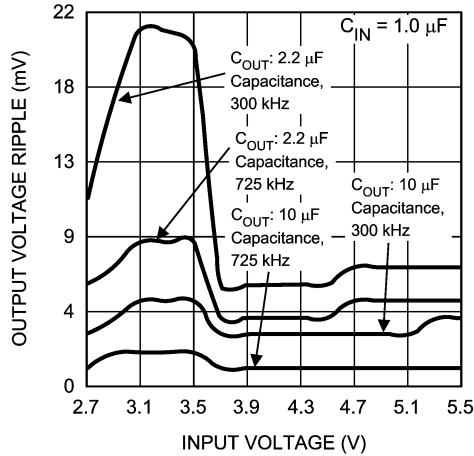

20112129

**Output Voltage Ripple, Version B (4.5V)**

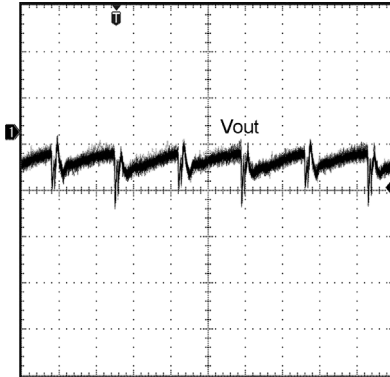

20112126

$V_{IN} = 3.6\text{V}$ , Load = 150mA  
CH1:  $V_{OUT}$ ; Scale: 10mV/Div, AC Coupled  
Time scale: 400ns/Div

**Line Step Response, Version B (4.5V)**

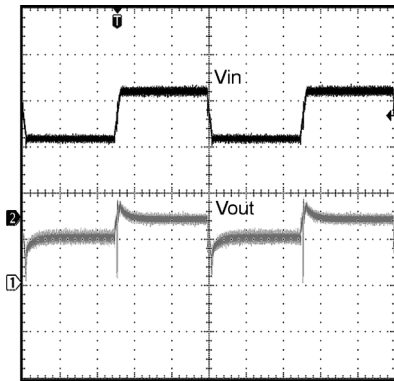

20112124

$V_{IN} = 3.2\text{V} - 4.2\text{V}$  Step, Load = 150mA  
CH1 (top):  $V_{IN}$ ; Scale: 1V/Div, DC Coupled  
CH2:  $V_{OUT}$ ; Scale: 50mV/Div, AC Coupled  
Time scale: 200μs/Div

**Load Step Response, Version B (4.5V)**

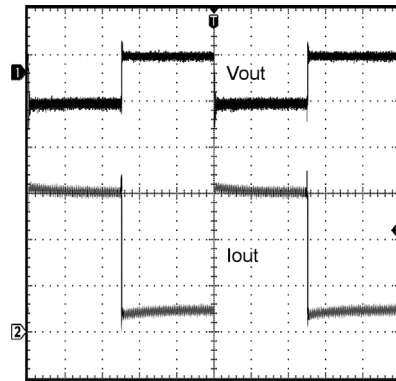

20112127

$V_{IN} = 3.6\text{V}$ , Load = 20mA - 150mA Step  
CH1 (top):  $V_{OUT}$ ; Scale: 50mV/Div, AC Coupled  
CH2: Output Current; Scale: 50mA/Div  
Time scale: 200μs/Div

**Start-up Behavior, Version A (5V), Load = 80mA**

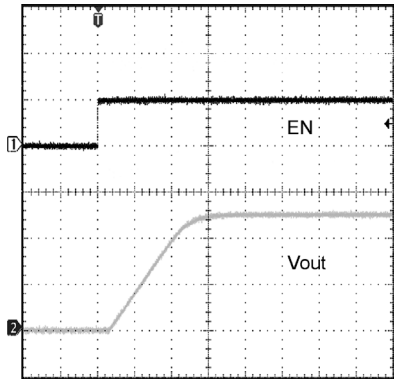

20112122

CH1: EN pin; Scale: 2V/Div  
CH2:  $V_{OUT}$ ; Scale: 2V/Div  
Time scale: 100μs/Div

**Start-up Behavior, Version B (4.5V), Load = 150mA**

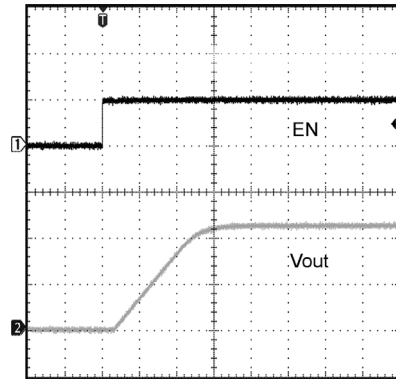

20112123

CH1: EN pin; Scale: 2V/Div  
CH2:  $V_{OUT}$ ; Scale: 2V/Div  
Time scale: 100μs/Div



## Application Information

### CIRCUIT DESCRIPTION

The LM2751 is a Switched Capacitor Converter with gains of 2x and 1.5x. It is capable of continuously supplying up to 150mA at 4.5V or up to 80mA at 5V depending on the output voltage option. The LM2751's fixed frequency pre-regulation maintains the output voltage to within 3% (typ.), making it well suited for driving White LEDs. There are also four user programmable switching frequencies to reduce the quiescent current consumption at light loads.

Aside from powering LEDs, the LM2751 is suitable for driving other devices with power requirements up to 150mA. The LM2751 operates over the extended Li-Ion battery range from 2.8V to 5.5V. The LM2751 limits output current to 250mA (typ.) during an output short circuit condition. LED brightness is controlled by applying a PWM (Pulse Width Modulation) signal to the Enable pin (EN). (see **PWM BRIGHTNESS CONTROL** section).

### SOFT START

Soft Start is engaged when the device is taken out of Shut-down mode (EN = logic HIGH) or when voltage is supplied simultaneously to the  $V_{IN}$  and EN pins. During Soft Start, the voltage on  $V_{OUT}$  will ramp up in proportion to the rate that the reference voltage is being ramped up. The output voltage is programmed to rise from 0V to the regulated output voltage level (4.5V or 5V) in 300 $\mu$ s (typ.).

### ENABLE MODE

The Enable logic pin (EN) disables the part and reduces the quiescent current to 0.77 $\mu$ A (typ.). The LM2751 has an active-high enable pin (LOW = shut down, HIGH = operating) which can be driven with a low-voltage CMOS logic signal (1.5V logic, 1.8V logic, etc). There is an internal 1M $\Omega$  pull-down resistor between the EN and GND pins of the LM2751.

### FREQUENCY MODE SELECT

The LM2751 switching frequency is user programmable via two logic input pins, CS0 and CS1. Both logic input pins have active-high logic (LOW = un-selected, HIGH = selected) and can be driven with a low-voltage CMOS logic signal (1.5V logic, 1.8V logic, etc). There are no internal pull-down or pull-up resistors between the CSx and GND pins of the LM2751. The CS0 and CS1 can be controlled independently or with the same logic signal.

The selectable switching frequencies are 9.5kHz, 37kHz, 300kHz, 725kHz. The switching frequency is programmed according to *Table 1*

**TABLE 1. Frequency Modes**

CS0	CS1	Frequency
0	0	37kHz
0	1	300kHz
1	0	9.5kHz
1	1	725kHz

### $V_{OUT}$ REGULATION

The LM2751 uses pre-regulation to regulate the output voltage to 4.5V or 5.0V depending on the voltage option. Pre-regulation uses the voltage present at  $V_{OUT}$  to limit the gate

drive of the switched capacitor charge pump. This regulation is done before the voltage is gained up by the charge pump, giving rise to the term "pre-regulation". Pre-regulation helps to reduce input current noise and large input current spikes normally associated with switched capacitor charge pumps.

The LM2751 switched capacitor charge pump has gains of 2x and 1.5x. When the input voltage to the device is greater than 3.58V (typ.), the LM2751 operates in a gain of 1.5x. When the input voltage falls below 3.5V (typ.), the device switches to a gain of 2x.

### OUTPUT VOLTAGE RIPPLE

The primary contributor in keeping the output voltage ripple of the LM2751 low is its switching topology. The output capacitance, input voltage, switching frequency and output current also play a significant part in determining the output voltage ripple. Due to the complexity of the LM2751 operation, providing equations or models to approximate the magnitude of the ripple cannot be easily accomplished. However, the following general statements can be made.

The LM2751 has very low output ripple when compared to typical boost regulators due to its double-pump topology, where charge is continually supplied to the output during both 2x and 1.5x modes. Combined with fixed frequency operation modes, double-pumping allows for the use of a very small, low value ceramic capacitor on the output node while still achieving minimal output ripple. Increasing the capacitance by adding a higher value capacitor or placing multiple capacitors in parallel can further reduce the ripple magnitude.

### CAPACITOR SELECTION

The LM2751 requires 4 external capacitors for proper operation. Surface-mount multi-layer ceramic capacitors are recommended. These capacitors are small, inexpensive and have very low equivalent series resistance (ESR,  $\leq 15$ m $\Omega$  typ.). Tantalum capacitors, OS-CON capacitors, and aluminum electrolytic capacitors are generally not recommended for use with the LM2751 due to their high ESR, as compared to ceramic capacitors.

For most applications, ceramic capacitors with X7R or X5R temperature characteristic are preferred for use with the LM2751. These capacitors have tight capacitance tolerance (as good as  $\pm 10\%$ ), hold their value over temperature (X7R:  $\pm 15\%$  over  $-55^{\circ}\text{C}$  to  $125^{\circ}\text{C}$ ; X5R:  $\pm 15\%$  over  $-55^{\circ}\text{C}$  to  $85^{\circ}\text{C}$ ), and typically have little voltage coefficient when compared to other types of capacitors. However selecting a capacitor with a voltage rating much higher than the voltage it will be subjected to, will ensure that the capacitance will stay closer to the capacitor's nominal value. Capacitors with Y5V or Z5U temperature characteristic are generally not recommended for use with the LM2751. Capacitors with these temperature characteristics typically have wide capacitance tolerance (+80%, -20%), vary significantly over temperature (Y5V: +22%, -82% over  $-30^{\circ}\text{C}$  to  $+85^{\circ}\text{C}$  range; Z5U: +22%, -56% over  $+10^{\circ}\text{C}$  to  $+85^{\circ}\text{C}$  range), and have poor voltage coefficients. Under some conditions, a nominal 1 $\mu$ F Y5V or Z5U capacitor could have a capacitance of only 0.1 $\mu$ F. Such detrimental deviation is likely to cause Y5V and Z5U capacitors to fail to meet the minimum capacitance requirements of the LM2751.

## Application Information (Continued)

The voltage rating of the output capacitor should be 10V or more. All other capacitors should have a voltage rating at or above the maximum input voltage of the application.

### DRIVING WHITE LEDs

The desired LED current is set by placing a resistor (R) in series with each LED, and is determined by the equation:

$$I_{LED} = (V_{OUT} - V_{LED}) \div R$$

In the equation above,  $I_{LED}$  is the current that flows through a particular LED, and  $V_{LED}$  is the forward voltage of the LED at the given current. The output voltage ( $V_{OUT}$ ) of the LM2751 is tightly regulated to 4.5V or 5V depending on the output voltage option. However, LED forward voltage varies from LED to LED, and LED current will vary accordingly. Mismatch of LED currents will result in brightness mismatch from one LED to the next. Therefore it is suggested that LED groups with tightly controlled I-V characteristics ("Binned" LEDs) be used. LEDs with looser tolerance can be used in applications where brightness matching is not critical, such as in keypad or general backlighting. The typical and maximum diode forward voltage depends highly on the manufacturer and their technology.

### PWM BRIGHTNESS CONTROL

Perceived LED brightness can be adjusted using a PWM control signal on the Enable pin of the LM2751, to turn the voltage output ON and OFF at a rate faster than perceptible by the eye. When this is done, the total brightness perceived is proportional to the duty cycle (D) of the PWM signal (D = the percentage of time that the LED is on in every PWM cycle). A simple example: if the LEDs are driven at 15mA each with a PWM signal that has a 50% duty cycle, perceived LED brightness will be about half as bright as compared to when the LEDs are driven continuously with 15mA. For linear brightness control over the full duty cycle adjustment range, the PWM frequency (f) should be limited to accommodate the turn-on time (typ.  $T_{ON} = 300\mu s$ ) of the device.

$$D \times (1/f) > T_{ON}$$

$$f_{MAX} = D_{MIN} \div T_{ON}$$

The minimum recommended PWM frequency is 100Hz. Frequencies below this may be visibly noticeable as flicker or blinking. The maximum recommended PWM frequency is 1kHz. Frequencies above this may cause noise in the audible range.

### THERMAL PROTECTION

When the junction temperature exceeds 150°C (typ.), internal thermal protection circuitry disables the device. This feature protects the LM2751 from damage due to excessive power dissipation. The device will recover and operate normally when the junction temperature falls below 140°C (typ.). It is important to have good thermal conduction with a proper layout to reduce thermal resistance.

### POWER EFFICIENCY

Charge-Pump efficiency is derived in the following two ideal equations (supply current and other losses are neglected for simplicity):

$$I_{IN} = G \times I_{OUT}$$

$$E = (V_{OUT} \times I_{OUT}) \div (V_{IN} \times I_{IN}) = V_{OUT} \div (G \times V_{IN})$$

In the equations, G represents the charge pump gain. Efficiency is at its highest as  $G \times V_{IN}$  approaches  $V_{OUT}$ . Refer to the efficiency graph in the **Typical Performance Characteristics** section for the detailed efficiency data.

### POWER DISSIPATION

The power dissipation ( $P_{DISSIPATION}$ ) and junction temperature ( $T_J$ ) can be approximated with the equations below.  $P_{IN}$  is the product of the input current and input voltage,  $P_{OUT}$  is the power consumed by the load connected to the output,  $T_A$  is the ambient temperature, and  $\theta_{JA}$  is the junction-to-ambient thermal resistance for the LLP-10 package.  $V_{IN}$  is the input voltage to the LM2751,  $V_{VOUT}$  is the voltage at the output of the device, and  $I_{OUT}$  is the total current supplied to the load connected to  $V_{OUT}$ .

$$P_{DISSIPATION} = P_{IN} - P_{OUT}$$

$$= (V_{IN} \times I_{IN}) - (V_{VOUT} \times I_{OUT})$$

$$T_J = T_A + (P_{DISSIPATION} \times \theta_{JA})$$

The junction temperature rating takes precedence over the ambient temperature rating. The LM2751 may be operated outside the ambient temperature rating, so long as the junction temperature of the device does not exceed the maximum operating rating of 115°C. The maximum ambient temperature rating must be derated in applications where high power dissipation and/or poor thermal resistance causes the junction temperature to exceed 115°C.

**Physical Dimensions** inches (millimeters) unless otherwise noted

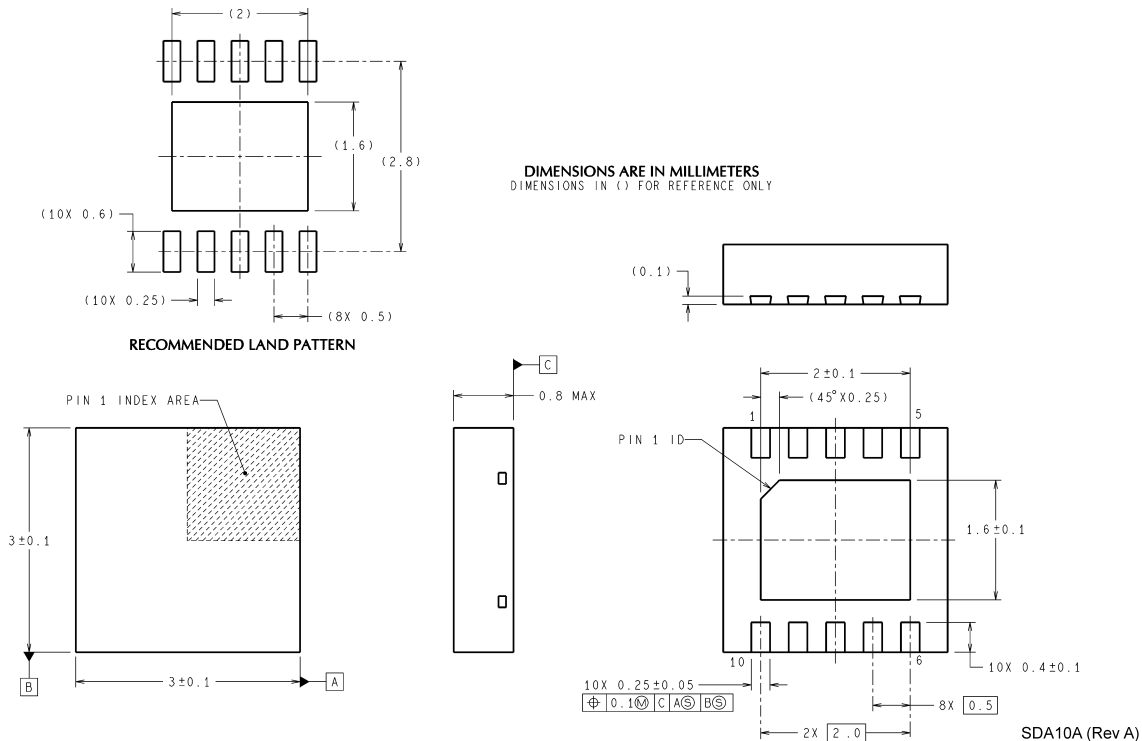

National does not assume any responsibility for use of any circuitry described, no circuit patent licenses are implied and National reserves the right at any time without notice to change said circuitry and specifications.

For the most current product information visit us at [www.national.com](http://www.national.com).

**LIFE SUPPORT POLICY**

NATIONAL'S PRODUCTS ARE NOT AUTHORIZED FOR USE AS CRITICAL COMPONENTS IN LIFE SUPPORT DEVICES OR SYSTEMS WITHOUT THE EXPRESS WRITTEN APPROVAL OF THE PRESIDENT AND GENERAL COUNSEL OF NATIONAL SEMICONDUCTOR CORPORATION. As used herein:

1. Life support devices or systems are devices or systems which, (a) are intended for surgical implant into the body, or (b) support or sustain life, and whose failure to perform when properly used in accordance with instructions for use provided in the labeling, can be reasonably expected to result in a significant injury to the user.
2. A critical component is any component of a life support device or system whose failure to perform can be reasonably expected to cause the failure of the life support device or system, or to affect its safety or effectiveness.

**BANNED SUBSTANCE COMPLIANCE**

National Semiconductor manufactures products and uses packing materials that meet the provisions of the Customer Products Stewardship Specification (CSP-9-111C2) and the Banned Substances and Materials of Interest Specification (CSP-9-111S2) and contain no "Banned Substances" as defined in CSP-9-111S2.

**National Semiconductor**  
Americas Customer  
Support Center  
Email: [new.feedback@nsc.com](mailto:new.feedback@nsc.com)  
Tel: 1-800-272-9959

**National Semiconductor**  
Europe Customer Support Center  
Fax: +49 (0) 180-530 85 86  
Email: [europe.support@nsc.com](mailto:europe.support@nsc.com)  
Deutsch Tel: +49 (0) 69 9508 6208  
English Tel: +44 (0) 870 24 0 2171  
Français Tel: +33 (0) 1 41 91 8790

**National Semiconductor**  
Asia Pacific Customer  
Support Center  
Email: [ap.support@nsc.com](mailto:ap.support@nsc.com)

**National Semiconductor**  
Japan Customer Support Center  
Fax: 81-3-5639-7507  
Email: [jpn.feedback@nsc.com](mailto:jpn.feedback@nsc.com)  
Tel: 81-3-5639-7560

[www.national.com](http://www.national.com)