

MC14543B

BCD-to-Seven Segment Latch/Decoder/Driver for Liquid Crystals

The MC14543B BCD-to-seven segment latch/decoder/driver is designed for use with liquid crystal readouts, and is constructed with complementary MOS (CMOS) enhancement mode devices. The circuit provides the functions of a 4-bit storage latch and an 8421 BCD-to-seven segment decoder and driver. The device has the capability to invert the logic levels of the output combination. The phase (Ph), blanking (BI), and latch disable (LD) inputs are used to reverse the truth table phase, blank the display, and store a BCD code, respectively. For liquid crystal (LC) readouts, a square wave is applied to the Ph input of the circuit and the electrically common backplane of the display. The outputs of the circuit are connected directly to the segments of the LC readout. For other types of readouts, such as light-emitting diode (LED), incandescent, gas discharge, and fluorescent readouts, connection diagrams are given on this data sheet.

Applications include instrument (e.g., counter, DVM etc.) display driver, computer/calculator display driver, cockpit display driver, and various clock, watch, and timer uses.

Features

- Latch Storage of Code
- Blanking Input
- Readout Blanking on All Illegal Input Combinations
- Direct LED (Common Anode or Cathode) Driving Capability
- Supply Voltage Range = 3.0 V to 18 V
- Capable of Driving 2 Low-power TTL Loads, 1 Low-power Schottky TTL Load or 2 HTL Loads Over the Rated Temperature Range
- Pin-for-Pin Replacement for CD4056A (with Pin 7 Tied to V_{SS}).
- Chip Complexity: 207 FETs or 52 Equivalent Gates
- Pb-Free Packages are Available*

MAXIMUM RATINGS (Voltages Referenced to V_{SS})

| Parameter | Symbol | Value | Unit |
|---|----------------------------|------------------------|-------------|
| DC Supply Voltage Range | V_{DD} | -0.5 to +18.0 | V |
| Input Voltage Range, All Inputs | V_{in} | -0.5 to $V_{DD} + 0.5$ | V |
| DC Input Current per Pin | I_{in} | ± 10 | mA |
| Power Dissipation per Package (Note 1) | P_D | 500 | mW |
| Operating Temperature Range | T_A | -55 to +125 | $^{\circ}C$ |
| Storage Temperature Range | T_{stg} | -65 to +150 | $^{\circ}C$ |
| Maximum Continuous Output Drive Current (Source or Sink) | I_{OHmax} I_{OLmax} | 10 (per Output) | mA |
| Maximum Continuous Output Power (Source or Sink) (Note 2) | P_{OHmax} P_{OLmax} | 70 (per Output) | mW |

Stresses exceeding Maximum Ratings may damage the device. Maximum Ratings are stress ratings only. Functional operation above the Recommended Operating Conditions is not implied. Extended exposure to stresses above the Recommended Operating Conditions may affect device reliability.

1. Temperature Derating: Plastic "P and D/DW"
Packages: - 7.0 mW/ $^{\circ}C$ From 65 $^{\circ}C$ To 125 $^{\circ}C$
2. $P_{OHmax} = I_{OH} (V_{OH} - V_{DD})$ and $P_{OLmax} = I_{OL} (V_{OL} - V_{SS})$



ON Semiconductor®

<http://onsemi.com>

MARKING DIAGRAMS

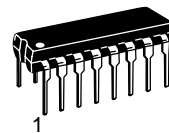

PDP-16
P SUFFIX
CASE 648

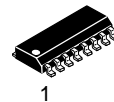
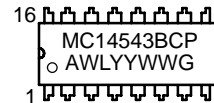

SOIC-16
D SUFFIX
CASE 751B

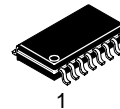
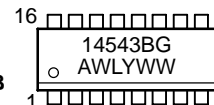

SOEIAJ-16
F SUFFIX
CASE 966



A = Assembly Location
WL, L = Wafer Lot
YY, Y = Year
WW, W = Work Week
G = Pb-Free Package

ORDERING INFORMATION

See detailed ordering and shipping information in the package dimensions section on page 2 of this data sheet.

This device contains protection circuitry to guard against damage due to high static voltages or electric fields. However, precautions must be taken to avoid applications of any voltage higher than maximum rated voltages to this high-impedance circuit. For proper operation, V_{in} and V_{out} should be constrained to the range $V_{SS} \leq (V_{in} \text{ or } V_{out}) \leq V_{DD}$.

Unused inputs must always be tied to an appropriate logic voltage level (e.g., either V_{SS} or V_{DD}). Unused outputs must be left open.

*For additional information on our Pb-Free strategy and soldering details, please download the ON Semiconductor Soldering and Mounting Techniques Reference Manual, SOLDERRM/D.

MC14543B

TRUTH TABLE

PIN ASSIGNMENT

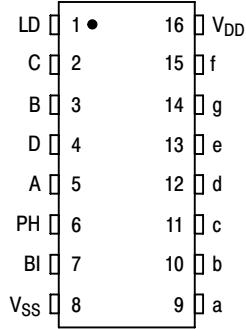

| Inputs | | | | | | | Outputs | | | | | | | |
|--------|----|-----|---|---|---|---|--------------------------------------|---|---|---|---|---|---|------------------|
| LD | BI | Ph* | D | C | B | A | a | b | c | d | e | f | g | Display |
| X | 1 | 0 | X | X | X | X | 0 | 0 | 0 | 0 | 0 | 0 | 0 | Blank |
| 1 | 0 | 0 | 0 | 0 | 0 | 0 | 1 | 1 | 1 | 1 | 1 | 1 | 0 | 0 |
| 1 | 0 | 0 | 0 | 0 | 0 | 1 | 0 | 1 | 1 | 0 | 0 | 0 | 0 | 1 |
| 1 | 0 | 0 | 0 | 0 | 1 | 0 | 1 | 1 | 0 | 1 | 1 | 0 | 1 | 2 |
| 1 | 0 | 0 | 0 | 0 | 1 | 1 | 1 | 1 | 1 | 1 | 0 | 0 | 1 | 3 |
| 1 | 0 | 0 | 0 | 1 | 0 | 0 | 0 | 0 | 1 | 1 | 0 | 0 | 1 | 4 |
| 1 | 0 | 0 | 0 | 1 | 0 | 1 | 1 | 0 | 1 | 1 | 0 | 1 | 1 | 5 |
| 1 | 0 | 0 | 0 | 1 | 1 | 0 | 1 | 0 | 1 | 1 | 1 | 1 | 1 | 6 |
| 1 | 0 | 0 | 0 | 1 | 1 | 1 | 1 | 1 | 1 | 0 | 0 | 0 | 0 | 7 |
| 1 | 0 | 0 | 1 | 0 | 0 | 0 | 1 | 1 | 1 | 1 | 1 | 1 | 1 | 8 |
| 1 | 0 | 0 | 1 | 0 | 0 | 1 | 1 | 1 | 1 | 0 | 0 | 1 | 1 | 9 |
| 1 | 0 | 0 | 1 | 0 | 1 | 0 | 0 | 0 | 0 | 0 | 0 | 0 | 0 | Blank |
| 1 | 0 | 0 | 1 | 0 | 1 | 1 | 0 | 0 | 0 | 0 | 0 | 0 | 0 | Blank |
| 1 | 0 | 0 | 1 | 1 | 0 | 0 | 0 | 0 | 0 | 0 | 0 | 0 | 0 | Blank |
| 1 | 0 | 0 | 1 | 1 | 1 | 0 | 0 | 0 | 0 | 0 | 0 | 0 | 0 | Blank |
| 1 | 0 | 0 | 1 | 1 | 1 | 1 | 0 | 0 | 0 | 0 | 0 | 0 | 0 | Blank |
| 0 | 0 | 0 | X | X | X | X | ** | | | | | | | ** |
| † | † | † | † | | | | Inverse of Output Combinations Above | | | | | | | Display as above |

X = Don't care

† = Above Combinations

* = For liquid crystal readouts, apply a square wave to Ph

For common cathode LED readouts, select Ph = 0

For common anode LED readouts, select Ph = 1

** = Depends upon the BCD code previously applied when LD = 1

ORDERING INFORMATION

| Device | Package | Shipping† |
|--------------|---------------------|--------------------|
| MC14543BCP | PDIP-16 | 25 Units / Rail |
| MC14543BCPG | PDIP-16 (Pb-Free) | |
| MC14543BD | SOIC-16 | 48 Units / Rail |
| MC14543BDG | SOIC-16 (Pb-Free) | |
| MC14543BDR2 | SOIC-16 | 2500 / Tape & Reel |
| MC14543BDR2G | SOIC-16 (Pb-Free) | |
| MC14543BF | SOEIAJ-16 | 50 Units / Rail |
| MC14543BFG | SOEIAJ-16 (Pb-Free) | |

†For information on tape and reel specifications, including part orientation and tape sizes, please refer to our Tape and Reel Packaging Specifications Brochure, BRD8011/D.

MC14543B

ELECTRICAL CHARACTERISTICS (Voltages Referenced to V_{SS})

| Characteristic | Symbol | V _{DD} Vdc | - 55° C | | 25° C | | | 125° C | | Unit | |
|--|---|------------------------|---|-------|-------|-----------------|------|--------|------|------|------|
| | | | Min | Max | Min | Typ (Note 3) | Max | Min | Max | | |
| Output Voltage "0" Level V _{in} = V _{DD} or 0 | V _{OL} | 5.0 | – | 0.05 | – | 0 | 0.05 | – | 0.05 | Vdc | |
| | | 10 | – | 0.05 | – | 0 | 0.05 | – | 0.05 | | |
| 15 | | – | 0.05 | – | 0 | 0.05 | – | 0.05 | | | |
| "1" Level V _{in} = 0 or V _{DD} | V _{OH} | 5.0 | 4.95 | – | 4.95 | 5.0 | – | 4.95 | – | Vdc | |
| | | 10 | 9.95 | – | 9.95 | 10 | – | 9.95 | – | | |
| | | 15 | 14.95 | – | 14.95 | 15 | – | 14.95 | – | | |
| Input Voltage "0" Level (V _O = 4.5 or 0.5 Vdc) (V _O = 9.0 or 1.0 Vdc) (V _O = 13.5 or 1.5 Vdc) | V _{IL} | 5.0 | – | 1.5 | – | 2.25 | 1.5 | – | 1.5 | Vdc | |
| | | 10 | – | 3.0 | – | 4.50 | 3.0 | – | 3.0 | | |
| 15 | | – | 4.0 | – | 6.75 | 4.0 | – | 4.0 | | | |
| "1" Level (V _O = 0.5 or 4.5 Vdc) (V _O = 1.0 or 9.0 Vdc) (V _O = 1.5 or 13.5 Vdc) | V _{IH} | 5.0 | 3.5 | – | 3.5 | 2.75 | – | 3.5 | – | Vdc | |
| | | 10 | 7.0 | – | 7.0 | 5.50 | – | 7.0 | – | | |
| | | 15 | 11 | – | 11 | 8.25 | – | 11 | – | | |
| Output Drive Current Source (V _{OH} = 2.5 Vdc) (V _{OH} = 4.6 Vdc) (V _{OH} = 0.5 Vdc) (V _{OH} = 9.5 Vdc) (V _{OH} = 13.5 Vdc) | I _{OH} | 5.0 | –3.0 | – | –2.4 | –4.2 | – | –1.7 | – | mAdc | |
| | | 5.0 | –0.64 | – | –0.51 | –0.88 | – | –0.36 | – | | |
| | | 10 | – | – | – | –10.1 | – | – | – | | |
| | | 10 | –1.6 | – | –1.3 | –2.25 | – | –0.9 | – | | |
| | | 15 | –4.2 | – | –3.4 | –8.8 | – | –2.4 | – | | |
| | | 15 | – | – | – | – | – | – | – | | |
| (V _{OL} = 0.4 Vdc) (V _{OL} = 0.5 Vdc) (V _{OL} = 9.5 Vdc) (V _{OL} = 1.5 Vdc) | I _{OL} | 5.0 | 0.64 | – | 0.51 | 0.88 | – | 0.36 | – | mAdc | |
| | | 10 | 1.6 | – | 1.3 | 2.25 | – | 0.9 | – | | |
| | | 10 | – | – | – | 10.1 | – | – | – | | |
| | | 15 | 4.2 | – | 3.4 | 8.8 | – | 2.4 | – | | |
| Input Current | I _{in} | 15 | – | ±0.1 | – | ±0.00001 | ±0.1 | – | ±1.0 | μAdc | |
| Input Capacitance | C _{in} | – | – | – | – | 5.0 | 7.5 | – | – | pF | |
| Quiescent Current (Per Package) V _{in} = 0 or V _{DD} , I _{out} = 0 μA | I _{DD} | 5.0 | – | 5.0 | – | 0.005 | 5.0 | – | 150 | μAdc | |
| 10 | – | 10 | – | 0.010 | 10 | – | 300 | | | | |
| 15 | – | 20 | – | 0.015 | 20 | – | 600 | | | | |
| Total Supply Current (Note 4, 5) (Dynamic plus Quiescent, Per Package) (C _L = 50 pF on all outputs, all buffers switching) | I _T | 5.0 | I _T = (1.6 μA/kHz) f + I _{DD} | | | | | | | | μAdc |
| 10 | I _T = (3.1 μA/kHz) f + I _{DD} | | | | | | | | | | |
| 15 | I _T = (4.7 μA/kHz) f + I _{DD} | | | | | | | | | | |

3. Noise immunity specified for worst-case input combination.

Noise Margin for both "1" and "0" level = 1.0 V min @ V_{DD} = 5.0 V
 2.0 V min @ V_{DD} = 10 V
 2.5 V min @ V_{DD} = 15 V

4. To calculate total supply current at loads other than 50 pF: I_T(C_L) = I_T(50 pF) + 3.5 × 10⁻³ (C_L – 50) V_{DD}f where: I_T is in μA (per package), C_L in pF, V_{DD} in V, and f in kHz is input frequency.

5. The formulas given are for the typical characteristics only at 25°C.

MC14543B

SWITCHING CHARACTERISTICS (Note 6) ($C_L = 50 \text{ pF}$, $T_A = 25^\circ\text{C}$)

| Characteristic | Symbol | V_{DD} | Min | Typ | Max | Unit |
|--|-----------|-----------------|-------------------|-------------------|--------------------|------|
| Output Rise Time $t_{TLH} = (3.0 \text{ ns/pF}) C_L + 30 \text{ ns}$ $t_{TLH} = (1.5 \text{ ns/pF}) C_L + 15 \text{ ns}$ $t_{TLH} = (1.1 \text{ ns/pF}) C_L + 10 \text{ ns}$ | t_{TLH} | 5.0 10 15 | – – – | 100 50 40 | 200 100 80 | ns |
| Output Fall Time $t_{THL} = (1.5 \text{ ns/pF}) C_L + 25 \text{ ns}$ $t_{THL} = (0.75 \text{ ns/pF}) C_L + 12.5 \text{ ns}$ $t_{THL} = (0.55 \text{ ns/pF}) C_L + 12.5 \text{ ns}$ | t_{THL} | 5.0 10 15 | – – – | 100 50 40 | 200 100 80 | ns |
| Turn-Off Delay Time $t_{PLH} = (1.7 \text{ ns/pF}) C_L + 520 \text{ ns}$ $t_{PLH} = (0.66 \text{ ns/pF}) C_L + 217 \text{ ns}$ $t_{PLH} = (0.5 \text{ ns/pF}) C_L + 160 \text{ ns}$ | t_{PLH} | 5.0 10 15 | – – – | 605 250 185 | 1210 500 370 | ns |
| Turn-On Delay Time $t_{PHL} = (1.7 \text{ ns/pF}) C_L + 420 \text{ ns}$ $t_{PHL} = (0.66 \text{ ns/pF}) C_L + 172 \text{ ns}$ $t_{PHL} = (0.5 \text{ ns/pF}) C_L + 130 \text{ ns}$ | t_{PHL} | 5.0 10 15 | – – – | 505 205 155 | 1650 660 495 | ns |
| Setup Time | t_{su} | 5.0 10 15 | 350 450 500 | | – – – | ns |
| Hold Time | t_h | 5.0 10 15 | 40 30 20 | | – – – | ns |
| Latch Disable Pulse Width (Strobing Data) | t_{WH} | 5.0 10 15 | 250 100 80 | 125 50 40 | – – – | ns |

6. The formulas given are for the typical characteristics only.

LOGIC DIAGRAM

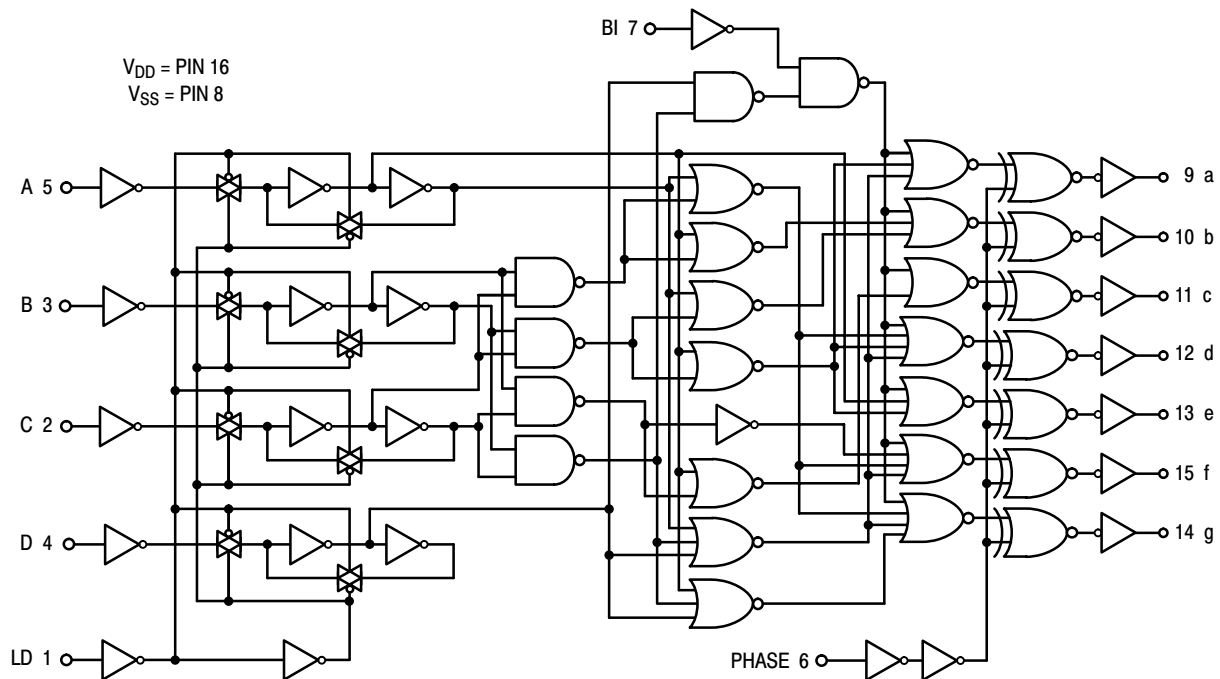

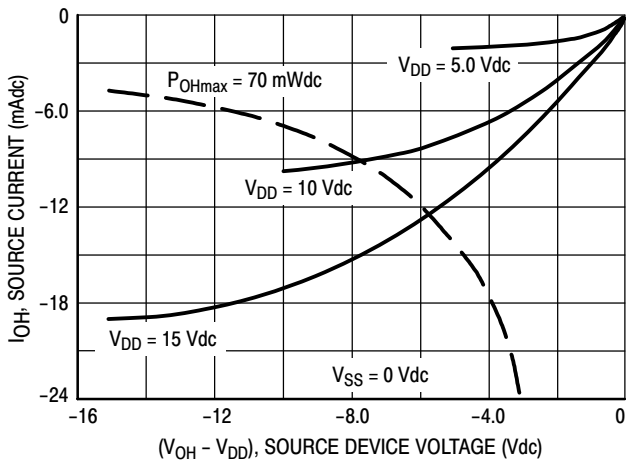

Figure 1. Typical Output Source Characteristics

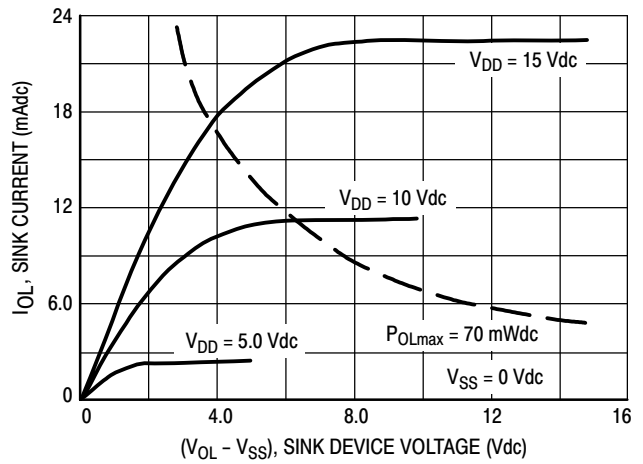

Figure 2. Typical Output Sink Characteristics

Inputs BI and Ph low, and Inputs D and LD high.
 f in respect to a system clock.
 All outputs connected to respective C_L loads.

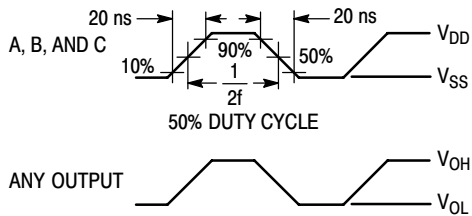
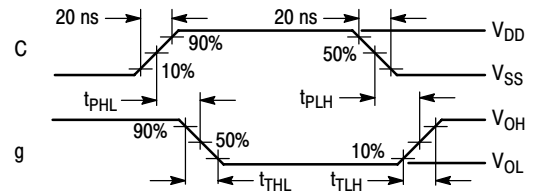
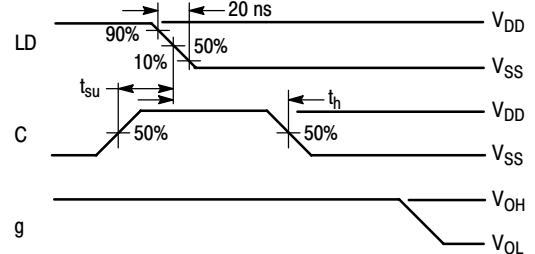

Figure 3. Dynamic Power Dissipation Signal Waveforms

(a) Inputs D, Ph, and BI low, and Inputs A, B, and LD high.



(b) Inputs D, Ph, and BI low, and Inputs A and B high.



(c) Data DCBA strobed into latches

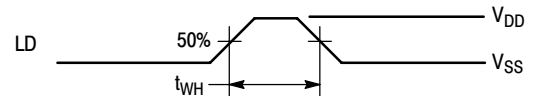
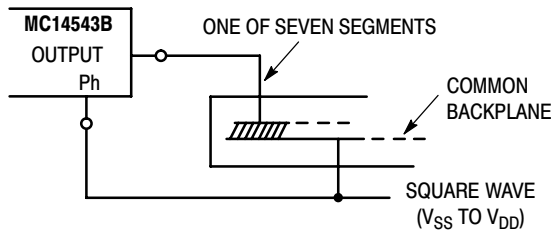

Figure 4. Dynamic Signal Waveforms

MC14543B

CONNECTIONS TO VARIOUS DISPLAY READOUTS

LIQUID CRYSTAL (LC) READOUT



INCANDESCENT READOUT

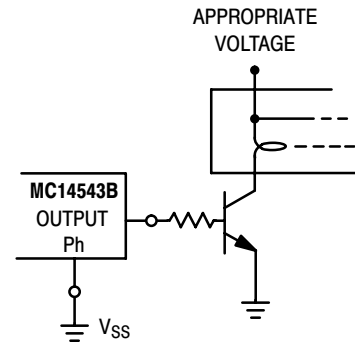

LIGHT EMITTING DIODE (LED) READOUT

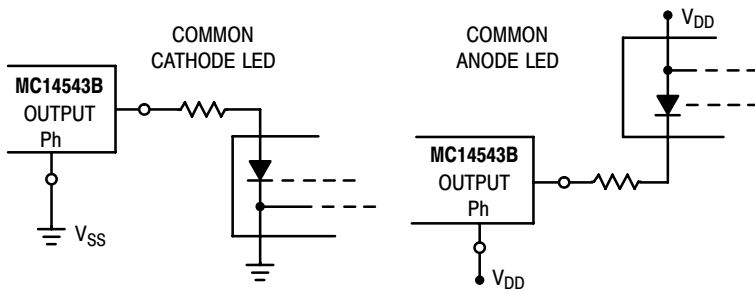

NOTE: Bipolar transistors may be added for gain (for $V_{DD} \leq 10$ V or $I_{out} \geq 10$ mA).

GAS DISCHARGE READOUT

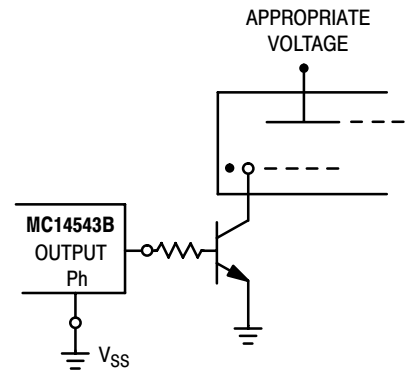

CONNECTIONS TO SEGMENTS

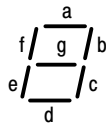

V_{DD} = PIN 16
 V_{SS} = PIN 8

DISPLAY

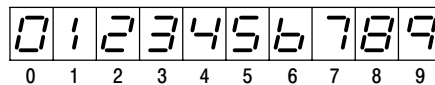

MC14543B

PACKAGE DIMENSIONS

PDIP-16
CASE 648-08
ISSUE T

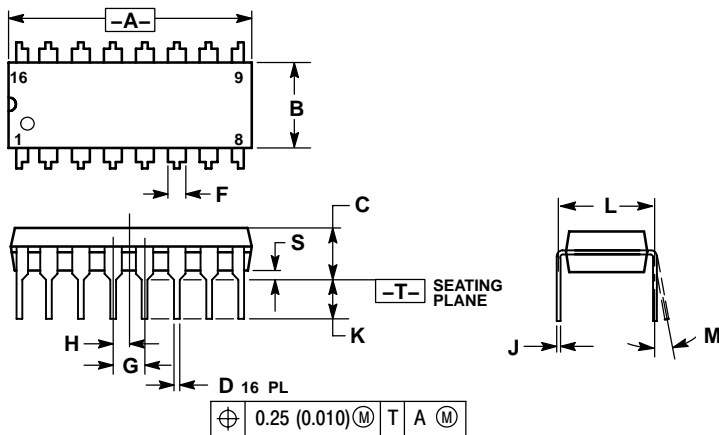

NOTES:

1. DIMENSIONING AND TOLERANCING PER ANSI Y14.5M, 1982.
2. CONTROLLING DIMENSION: INCH.
3. DIMENSION L TO CENTER OF LEADS WHEN FORMED PARALLEL.
4. DIMENSION B DOES NOT INCLUDE MOLD FLASH.
5. ROUNDED CORNERS OPTIONAL.

| DIM | INCHES | | MILLIMETERS | |
|-----|-----------|-------|-------------|-------|
| | MIN | MAX | MIN | MAX |
| A | 0.740 | 0.770 | 18.80 | 19.55 |
| B | 0.250 | 0.270 | 6.35 | 6.85 |
| C | 0.145 | 0.175 | 3.69 | 4.44 |
| D | 0.015 | 0.021 | 0.39 | 0.53 |
| F | 0.040 | 0.70 | 1.02 | 1.77 |
| G | 0.100 BSC | | 2.54 BSC | |
| H | 0.050 BSC | | 1.27 BSC | |
| J | 0.008 | 0.015 | 0.21 | 0.38 |
| K | 0.110 | 0.130 | 2.80 | 3.30 |
| L | 0.295 | 0.305 | 7.50 | 7.74 |
| M | 0° | 10° | 0° | 10° |
| S | 0.020 | 0.040 | 0.51 | 1.01 |

SOIC-16
CASE 751B-05
ISSUE J

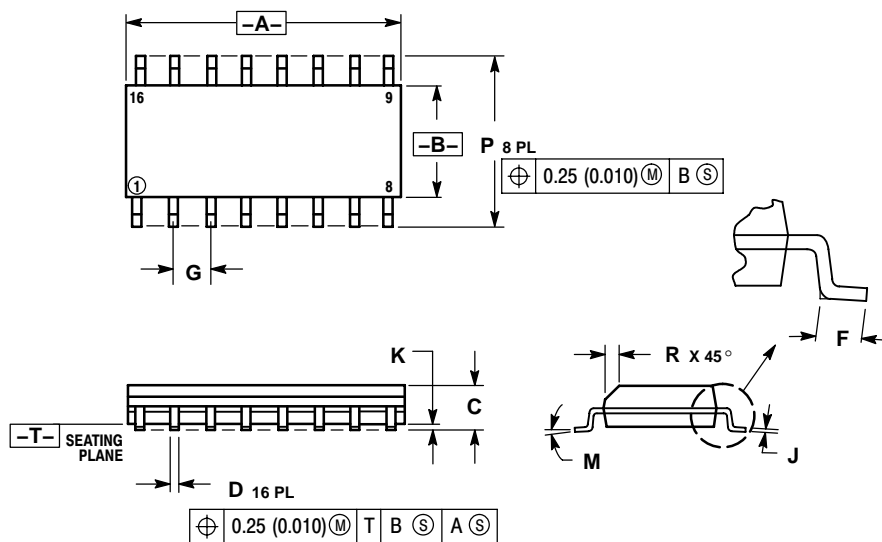

NOTES:

1. DIMENSIONING AND TOLERANCING PER ANSI Y14.5M, 1982.
2. CONTROLLING DIMENSION: MILLIMETER.
3. DIMENSIONS A AND B DO NOT INCLUDE MOLD PROTRUSION.
4. MAXIMUM MOLD PROTRUSION 0.15 (0.006) PER SIDE.
5. DIMENSION D DOES NOT INCLUDE DAMBAR PROTRUSION. ALLOWABLE DAMBAR PROTRUSION SHALL BE 0.127 (0.005) TOTAL IN EXCESS OF THE D DIMENSION AT MAXIMUM MATERIAL CONDITION.

| DIM | MILLIMETERS | | INCHES | |
|-----|-------------|-------|-----------|-------|
| | MIN | MAX | MIN | MAX |
| A | 9.80 | 10.00 | 0.386 | 0.393 |
| B | 3.80 | 4.00 | 0.150 | 0.157 |
| C | 1.35 | 1.75 | 0.054 | 0.068 |
| D | 0.35 | 0.49 | 0.014 | 0.019 |
| F | 0.40 | 1.25 | 0.016 | 0.049 |
| G | 1.27 BSC | | 0.050 BSC | |
| J | 0.19 | 0.25 | 0.008 | 0.009 |
| K | 0.10 | 0.25 | 0.004 | 0.009 |
| M | 0° | 7° | 0° | 7° |
| P | 5.80 | 6.20 | 0.229 | 0.244 |
| R | 0.25 | 0.50 | 0.010 | 0.019 |

MC14543B

PACKAGE DIMENSIONS

SOEIAJ-16
CASE 966-01
ISSUE A

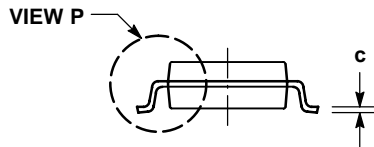
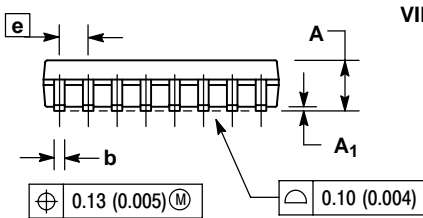
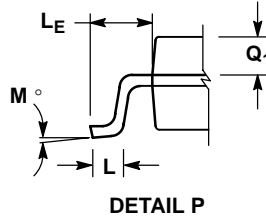
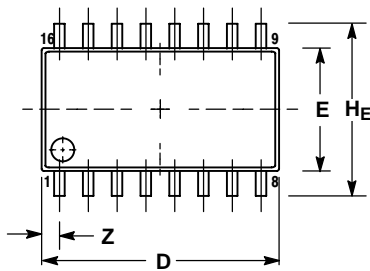

NOTES:

1. DIMENSIONING AND TOLERANCING PER ANSI Y14.5M, 1982.
2. CONTROLLING DIMENSION: MILLIMETER.
3. DIMENSIONS D AND E DO NOT INCLUDE MOLD FLASH OR PROTRUSIONS AND ARE MEASURED AT THE PARTING LINE. MOLD FLASH OR PROTRUSIONS SHALL NOT EXCEED 0.15 (0.006) PER SIDE.
4. TERMINAL NUMBERS ARE SHOWN FOR REFERENCE ONLY.
5. THE LEAD WIDTH DIMENSION (b) DOES NOT INCLUDE DAMBAR PROTRUSION. ALLOWABLE DAMBAR PROTRUSION SHALL BE 0.08 (0.003) TOTAL IN EXCESS OF THE LEAD WIDTH DIMENSION AT MAXIMUM MATERIAL CONDITION. DAMBAR CANNOT BE LOCATED ON THE LOWER RADIUS OR THE FOOT. MINIMUM SPACE BETWEEN PROTRUSIONS AND ADJACENT LEAD TO BE 0.46 (0.018).

| DIM | MILLIMETERS | | INCHES | |
|----------------|-------------|-------|-----------|-------|
| | MIN | MAX | MIN | MAX |
| A | --- | 2.05 | --- | 0.081 |
| A ₁ | 0.05 | 0.20 | 0.002 | 0.008 |
| b | 0.35 | 0.50 | 0.014 | 0.020 |
| c | 0.10 | 0.20 | 0.007 | 0.011 |
| D | 9.90 | 10.50 | 0.390 | 0.413 |
| E | 5.10 | 5.45 | 0.201 | 0.215 |
| e | 1.27 BSC | | 0.050 BSC | |
| H _E | 7.40 | 8.20 | 0.291 | 0.323 |
| L | 0.50 | 0.85 | 0.020 | 0.033 |
| L _E | 1.10 | 1.50 | 0.043 | 0.059 |
| M | 0° | 10° | 0° | 10° |
| Q ₁ | 0.70 | 0.90 | 0.028 | 0.035 |
| Z | --- | 0.78 | --- | 0.031 |

ON Semiconductor and are registered trademarks of Semiconductor Components Industries, LLC (SCILLC). SCILLC reserves the right to make changes without further notice to any products herein. SCILLC makes no warranty, representation or guarantee regarding the suitability of its products for any particular purpose, nor does SCILLC assume any liability arising out of the application or use of any product or circuit, and specifically disclaims any and all liability, including without limitation special, consequential or incidental damages. "Typical" parameters which may be provided in SCILLC data sheets and/or specifications can and do vary in different applications and actual performance may vary over time. All operating parameters, including "Typicals" must be validated for each customer application by customer's technical experts. SCILLC does not convey any license under its patent rights nor the rights of others. SCILLC products are not designed, intended, or authorized for use as components in systems intended for surgical implant into the body, or other applications intended to support or sustain life, or for any other application in which the failure of the SCILLC product could create a situation where personal injury or death may occur. Should Buyer purchase or use SCILLC products for any such unintended or unauthorized application, Buyer shall indemnify and hold SCILLC and its officers, employees, subsidiaries, affiliates, and distributors harmless against all claims, costs, damages, and expenses, and reasonable attorney fees arising out of, directly or indirectly, any claim of personal injury or death associated with such unintended or unauthorized use, even if such claim alleges that SCILLC was negligent regarding the design or manufacture of the part. SCILLC is an Equal Opportunity/Affirmative Action Employer. This literature is subject to all applicable copyright laws and is not for resale in any manner.

PUBLICATION ORDERING INFORMATION

LITERATURE FULFILLMENT:
Literature Distribution Center for ON Semiconductor
P.O. Box 5163, Denver, Colorado 80217 USA
Phone: 303-675-2175 or 800-344-3860 Toll Free USA/Canada
Fax: 303-675-2176 or 800-344-3867 Toll Free USA/Canada
Email: orderlit@onsemi.com

N. American Technical Support: 800-282-9855 Toll Free USA/Canada
Europe, Middle East and Africa Technical Support:
Phone: 421 33 790 2910
Japan Customer Focus Center
Phone: 81-3-5773-3850

ON Semiconductor Website: www.onsemi.com
Order Literature: <http://www.onsemi.com/orderlit>
For additional information, please contact your local Sales Representative

MC14543B/D