

High Voltage Current Regulators

IXC Series

$$V_{AK} = 450 \text{ V}$$

$$I_{A(P)} = 2 - 60 \text{ mA}$$

$$R_{DYN} = 9 - 900 \text{ k}\Omega$$

Preliminary Data Sheet

The IXYS IXC series of high voltage current regulators consists of non-switchable, 2-terminal, AC and DC current regulators.

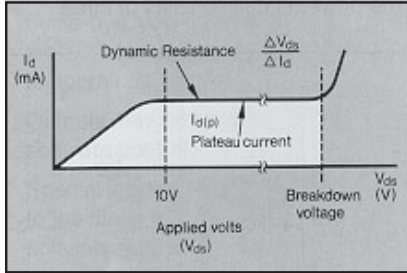

Fig. 1. Current Regulator Output Characteristics

Non-switchable regulators

This is a family of extremely stable, high voltage current regulators with the typical output characteristic shown in Figure 1. The temperature stability is based on a threshold compensation technique and uses IXYS' most recently developed high voltage process. The complete family will be capable of providing other intermediate current levels which can be programmed on-chip during the manufacturing phase.

Specific applications are current sourcing in PABX applications, telephone line terminations, surge protection and voltage supply protection. Two devices in a back-to-back configuration will give bidirectional operation. Specific bidirectional applications would be series surge protection and soft start-up applications from AC mains.

AC non-switchable regulators

This family consists of two DC current regulators connected internally in series to regulate the current to a specified value in both directions. Its output characteristics in quadrants 1 and 3 are the same as shown in Figure 1 so that the current regulation is also the same in both directions. Parts are only available in the TO-220 package.

Current Regulator Nomenclature

Parts can be ordered by using the following nomenclature:

IXCP10M45A	(Example)
IX	IXYS
C	Current Regulator Package style TO-220 AB
P	TO-252 (D-PAK)*
Y	Current Rating, 10 = 10 mA
10	Current Level A = Amps, M = mA, U = μ A
M	Voltage rating 45 = 450 V
45	

TO-252 AA (IXCY)

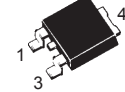

TO-220 AB (IXCP)

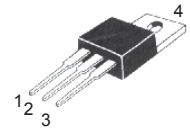

Features

- Extremely stable current characteristics (± 50 ppm/K)
- Minimum of 450 V breakdown
- Easily configured for bidirectional current sourcing
- 40 W continuous dissipation
- International standard packages JEDEC TO-220 and TO-252

Applications

- PABX current sources
- Telephone line terminations in PABXs and modems
- Highly stable voltage sources
- Surge limiters and voltage protection (DC and AC)
- Instantaneously reacting resettable fuses
- Waveform synthesizers
- Soft start-up circuits

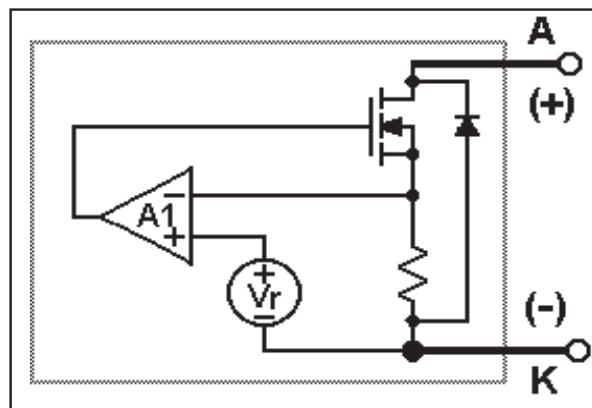

Fig. 2. Block diagram for the non-switchable regulator

Non-Switchable DC Current Regulators

Symbol	Definition	Maximum Ratings	
V_{AK}	Drain Source Voltage	450	V
P_D	Power Dissipation ($T_C = 25^\circ\text{C}$)	IXC_02M to IXC_50M	25 W
		IXC_60M & IXC_100M	40 W
I_{RM}	Maximum Reverse Current	1	A
T_J	Junction Operating Temperature	-55 to +150	$^\circ\text{C}$
T_{stg}	Storage Temperature	-55 to +150	$^\circ\text{C}$
T_L	Temperature for soldering (max. 10 s)	260	$^\circ\text{C}$
M_D	Mounting torque with screw M3 (TO-220) with screw M3.5 (TO-220)	0.45/4	Nm/lb.in.
		0.55/5	Nm/lb.in.

Symbol	Definition/Condition	Characteristic Values ($T_J = 25^\circ\text{C}$, unless otherwise specified)				
		min.	typ.	max.		
BV_{AK}^*	Breakdown voltage: ___M45	$I_D = 1.5 I_{A(P)}$	450		V	
$I_{A(P)}$	Plateau Current 02M___ 10M___ 20M___ 40M___ 50M___ 60M___ 100M___	$V_{AK} = 10\text{ V}$	1.9	2.0	2.5	mA
			9.0	10	11.8	mA
			18	20	22	mA
			36	40	44	mA
			45	50	55	mA
			56	60	64	mA
	88	100	110	mA		
$\Delta I_{A(P)}/\Delta T$	Plateau Current Shift with Temperature	$V_{AK} = 10\text{ V}$	± 50		ppm/K	
$\Delta V_{AK}/\Delta I_{A(P)}$	Dynamic Resistance	$V_{AK} = 10\text{ V}$	02M___	800	900	k Ω
			10M___	160	180	k Ω
			20M___	78	85	k Ω
			50M___	19	21	k Ω
			60M___	15	17	k Ω
			100M___	8	9	k Ω
V_F	Diode forward voltage drop; $I_F = 50\text{mA}$		1.8		V	
R_{thJC}	Thermal Resistance junction-to-case	IXC_02M to IXC_50M	5.0		K/W	
		IXC_60M & IXC_100M	3.1		K/W	
R_{thJA}	Thermal Resistance junction-to-ambient	TO-220	80		K/W	
		TO-252	100		K/W	

* Pulse test to limit power dissipation to within device capability.

Pin connections

- 1 = No connection
- 2, 4 = Positive terminal A
- 3 = Negative terminal A

Product Marking

TO-220 types - full part number
TO-252 - last 7 alpha-numeric characters of the part number, e.g. CY02M45

TO-220 AB Outline

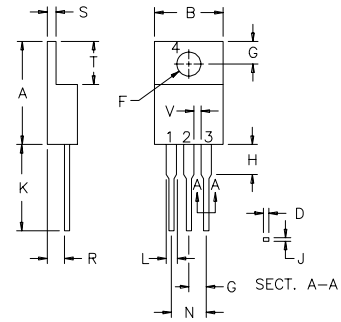

Dim.	Millimeter		Inches	
	Min.	Max.	Min.	Max.
A	14.23	16.51	.560	.650
B	9.66	10.66	.380	.420
C	3.56	4.82	.140	.190
D	0.64	0.89	.025	.035
F	3.54	4.06	.139	.161
G	2.29	2.79	.090	.110
H	-	6.35	-	.250
J	0.51	0.76	.020	.030
K	12.70	14.73	.500	.580
L	1.15	1.77	.045	.070
N	4.83	5.33	.190	.210
Q	2.54	3.42	.100	.135
R	2.04	2.49	.080	.115
S	0.64	1.39	.025	.055
T	5.85	6.85	2.30	2.70
V	1.15	-	.045	-

TO-252 AA Outline

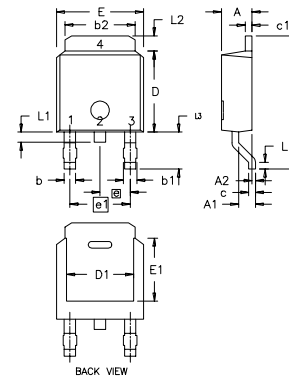

Dim.	Millimeter		Inches	
	Min.	Max.	Min.	Max.
A	2.19	2.38	0.086	0.094
A1	0.89	1.14	0.035	0.045
A2	0	0.13	0	0.005
b	0.64	0.89	0.025	0.035
b1	0.76	1.14	0.030	0.045
b2	5.21	5.46	0.205	0.215
c	0.46	0.58	0.018	0.023
c1	0.46	0.58	0.018	0.023
D	5.97	6.22	0.235	0.245
D1	4.32	5.21	0.170	0.205
E	6.35	6.73	0.250	0.265
E1	4.32	5.21	0.170	0.205
e	2.28 BSC		0.090 BSC	
e1	4.57 BSC		0.180 BSC	
H	9.40	10.42	0.370	0.410
L	0.51	1.02	0.020	0.040
L1	0.64	1.02	0.025	0.040
L2	0.89	1.27	0.035	0.050
L3	2.54	2.92	0.100	0.115

Application Examples

DC and AC Overvoltage Suppression

The regulator can be used as a voltage surge suppressor. The device is again connected in series with the load (Fig. 5) and would normally operate at a current level lower than the plateau (Fig. 6a). Any incoming voltage surge (Fig. 6b) less than the breakdown voltage of the regulator will be clamped by the IXCP regulator to voltage less than the plateau current times the effective resistance of the load.

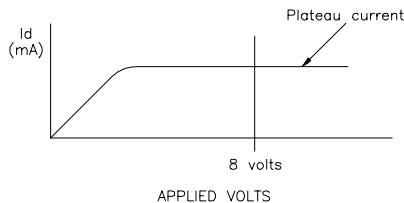

Fig. 6a. DC surge suppression

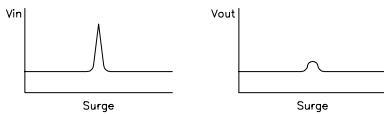

Fig. 6b. Incoming surge/output surge across load

Soft Start-Up Circuits

Here the regulator characteristic will clamp initial current surges which can occur when power is initially applied to a load. The device, with its 450 V capability could, for example, be used with a DC power supply or with AC mains to limit the initial high inrush of current into lamp filaments, thereby increasing the filament life several times. It could, therefore, be used effectively in lighting displays and in the transportation lighting industries.

Highly Stable Voltage Sources

Another obvious application would be to use the current regulator as a

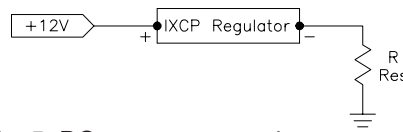

Fig. 5. DC surge suppression

source of a highly stable current to produce a usable voltage reference (Fig. 7). This would be effectively independent of temperature and a low cost approach. A high voltage reference is also possible, thanks to their high breakdown voltages.



$R = 100 \Omega$ $V_{out} = 3.5 \text{ V nominal}$
 $R = 50 \Omega$ $V_{out} = 1.75 \text{ V nominal}$
 $R = 25 \Omega$ $V_{out} = 0.875 \text{ V nominal}$

Fig. 7. Simple voltage source with high stability

Instantaneous "Fuse"

Another application would be protection against sudden voltage droops on voltage supply lines to logic cards in computing systems, resulting from one component suddenly shorting to ground. Normal fusing networks will draw considerable current during the time it takes for the fuse to clear. This could cause a sufficient dip in power rail voltage to cause malfunctions of the other logic cards, even with fast-blow fuses (Fig. 8). The current regulator in series with the logic card restricts the current to its own operating level (Fig. 9). Therefore the voltage supply does not become overloaded and the regulator remains intact.

The current regulator thus provides an "instantaneous fusing" function. When the logic component is replaced, the regulator resumes its normal functioning mode.

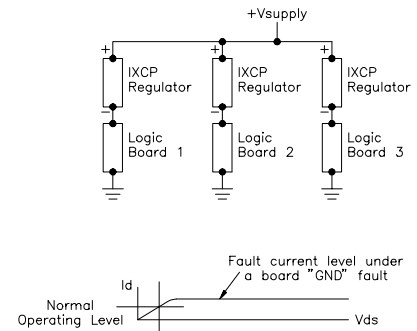

Fig.8. Low cost current regulators instead of fuses

The obvious advantages to having this regulator as fuse substitute are:

- Prevents a "dip" in the power supply during a fault condition
- Regulator remains intact
- Can be easily tied in with logic to indicate a "down state" board

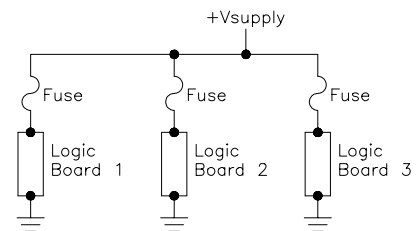

Fig. 9. Normal fusing links in series with each board

Testing & Handling Recommendations

- For initial assessment of the parts where the customer may test the device characteristics in free air without heat sinking, the continuous power dissipation should be kept within 1.5 W at ambient of 25°C. ($R_{thJA} = 80 \text{ K/W}$ for TO-220, and $R_{thJA} = 100 \text{ K/W}$ for TO-252)
- Normal electrostatic handling precautions for MOS devices should be adhered to.

IXYS MOSFETs and IGBTs are covered by 4,835,592 4,931,844 5,049,961 5,237,481 6,162,665 6,404,065 B1 6,683,344 6,727,585
 one or more of the following U.S. patents: 4,850,072 5,017,508 5,063,307 5,381,025 6,259,123 B1 6,534,343 6,710,405 B2 6,759,692
 4,881,106 5,034,796 5,187,117 5,486,715 6,306,728 B1 6,583,505 6,710,463