

# ZXCT1041

## Bidirectional precision high-side current monitor

### Description

The ZXCT1041 is a bidirectional precision high-side current sense monitor. The output voltage is proportional to the differential input voltage. Direction of current flow is indicated by the Flag pin.

The ZXCT1041 provides a fixed gain of 10 for applications where minimal external components are required.

The very low offset voltage enables a typical accuracy of 2% for sense voltages of only 10mV, giving better tolerances for small sense resistors necessary at higher currents.

The wide input voltage range of 20V down to as low as 2.7V make it suitable for a range of applications.

A minimum operating current of just 40 $\mu$ A, combined with a SOT23-5 package makes the ZXCT1041 particularly suitable for portable battery equipment.

### Features

- Bidirectional high side measurement
- Output voltage scaling x10
- 2.7V to 20V high side voltage
- 35 $\mu$ A quiescent current
- 1% typical accuracy
- SOT23-5 package

### Applications

- Battery management
- Over current monitor
- Battery gas gauging
- Motor control

### Pin connections

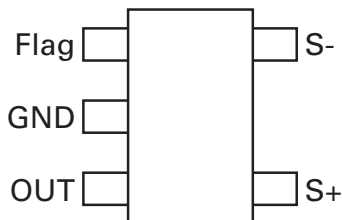

### Typical application circuit

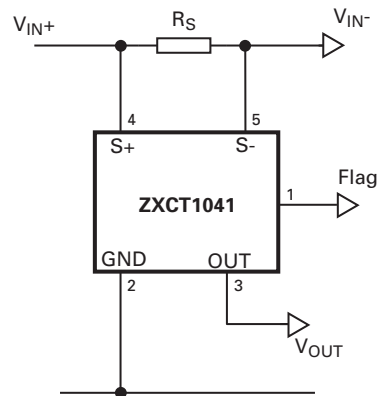

### Ordering information

| Order code   | Package | Partmark | Reel size (inches) | Tape width (mm) | Quantity per reel |
|--------------|---------|----------|--------------------|-----------------|-------------------|
| ZXCT1041E5TA | SOT23-5 | 1041     | 7                  | 8               | 3000              |

## Absolute maximum ratings

|                                     |  |
|-------------------------------------|--|
| Voltage on $V_{S-}$ and $V_{S+}$    | -0.6 to 20V  |
| Voltage on all other pins           | -0.6V to ( $V_{S+}$ or $V_{S-}$ ) +0.6V                      |
| $V_{sense} [(V_{S+}) - (V_{S-})]$   | +/-6V  |
| Operating temperature, $T_A$        | -40 to 125°C   |
| Storage temperature                 | -55 to 150°C   |
| Maximum junction temperature, $T_J$ | 150°C  |
| Package power dissipation           | 300mW at $T_A = 25^\circ\text{C}$ (De-rate to zero at 150°C) |

Operation above the absolute maximum rating may cause device failure. Operation at the absolute maximum ratings, for extended periods, may reduce device reliability.

## Recommended operating conditions

| Parameter   |  | Min. | Max.             | Units |
|-------------|--|------|------------------|-------|
| $V_{S\pm}$  | Common-mode sense input range          | 2.7  | 20               | V     |
| Flag        | Current direction flag output          | 0    | $V_{S\pm}$       | V     |
| $V_{SENSE}$ | Differential sense input voltage range | 0    | $\pm 0.8$        | V     |
| $V_{OUT}$   | Output voltage range                   | 0    | $V_{S\pm} - 1.5$ | V     |
| $T_A$       | Ambient temperature range              | -40  | 125              | °C    |

## Pin function table

| Pin | Name | Description   |
|-----|------|---|
| 1   | Flag | This is the current direction pin. It is open collector and allows the logic high level to be set independent of $V_{S+}$ voltage. Low indicates $V_{S+}$ is greater than $V_{S-}$ .                    |
| 2   | GND  | Ground pin  |
| 3   | OUT  | Output voltage pin  |
| 4   | S+   | This is the positive input of the current monitor. It also acts as the supply voltage pin providing current for internal circuitry. The current through this pin varies with differential sense voltage |
| 5   | S-   | This is the negative input of the current monitor. The current through this pin varies with differential sense voltage  |

## Electrical characteristics

Test conditions  $T_A = 25^\circ\text{C}$ ,  $V_{S+} = 10\text{V}$ ,  $V_{\text{SENSE}} = 100\text{mV}$

| Symbol              | Parameter                                   | Conditions  | Min. | Typ. | Max.    | Units                 |
|---------------------|---|---|------|------|---------|-----------------------|
| $I_Q$               | Ground pin current                          |   | 15   | 35   | 50      | $\mu\text{A}$         |
| $I_{S+}$            | $V_{S+}$ input current                      | $V_{\text{SENSE}} = 0\text{V}$  | 10   | 17   | 24      | $\mu\text{A}$         |
| $I_{S-}$            | $V_{S-}$ input current                      | $V_{\text{SENSE}} = 0\text{V}$  | 10   | 17   | 24      | $\mu\text{A}$         |
| $V_{\text{OUT}}$    | Output voltage<br>[flag high]               | $V_{\text{SENSE}} = +150\text{mV}$  | 1.55 | 1.5  | 1.45    | V                     |
|                     |   | $V_{\text{SENSE}} = +100\text{mV}$  | 1.02 | 1    | 0.98    | V                     |
|                     |   | $V_{\text{SENSE}} = +30\text{mV}$   | 309  | 300  | 291     | mV                    |
|                     | [flag low]                                  | $V_{\text{SENSE}} = 0\text{V}$  | 0    |      | 15      | mV                    |
|                     |   | $V_{\text{SENSE}} = -30\text{mV}$   | 285  | 300  | 315     | mV                    |
|                     |   | $V_{\text{SENSE}} = -100\text{mV}$  | 0.95 | 1    | 1.05    | V                     |
|                     |   | $V_{\text{SENSE}} = -150\text{mV}$  | 1.42 | 1.50 | 1.58    | V                     |
| $V_{\text{OUT TC}}$ | $V_{\text{OUT}}$ variation with temperature | $V_{\text{SENSE}} = \pm 100\text{mV}$   |      | 30   |         | ppm/ $^\circ\text{C}$ |
| Gain                | $V_{\text{OUT}}/V_{\text{SENSE}}$           |   |      | 10   |         |                       |
| Accuracy            | Total output error (Gain + offset)          | $V_{\text{SENSE}} = 100\text{mV}$   |      |      | $\pm 2$ | %                     |
| Accuracy            | Total output error (Gain + offset)          | $V_{\text{SENSE}} = -100\text{mV}$  |      |      | $\pm 5$ | %                     |
| BW                  | Bandwidth                                   | $V_{\text{SENSE(DC)}} = 100\text{mV}$<br>$V_{\text{SENSE(AC)}} = 63\text{mV}_{\text{PP}}$ |      | 300  |         | kHz                   |
| CMRR                | $V_{S+}$ common mode rejection ratio        | $V_{\text{IN}} = 2.7$ to $20\text{V}$   |      | 60   |         | dB                    |
| Flag TP             | Flag trip point                             | Referred to $V_{\text{SENSE}}$  | -2.5 |      | +2.5    | mV                    |
| $V_{\text{FL}}$     | Flag low output voltage                     | $I_{\text{SINK}} = 100\mu\text{A}$  |      | 60   | 200     | mV                    |
| $I_{\text{FH}}$     | Flag high leakage current                   | $V_{\text{OH}} = 5\text{V}$   |      |      | 1       | $\mu\text{A}$         |

### NOTES:

(a)  $V_{\text{SENSE}} = "V_{S+}" - "V_{S-}"$

(b) Temperature dependent measurements are extracted from characterisation and simulation results.

## Typical characteristics

Conditions  $V_{SENSE+}=10V$ ,  $V_{SENSE}=100mV$ ,  $T_A=25^\circ C$  unless otherwise stated.

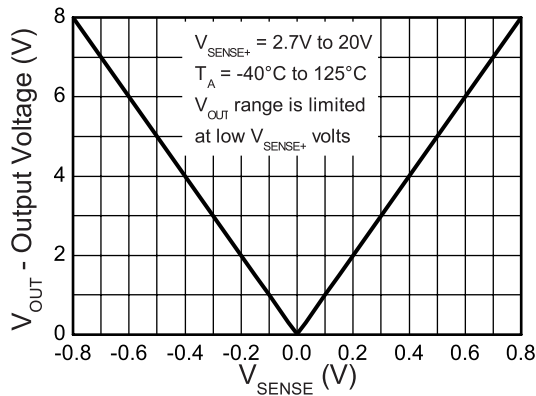

Output Voltage v Sense Voltage

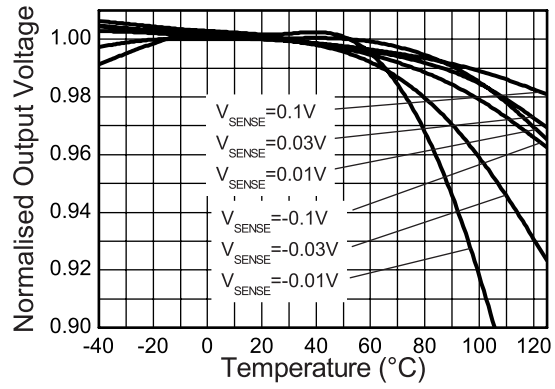

Output v Temperature

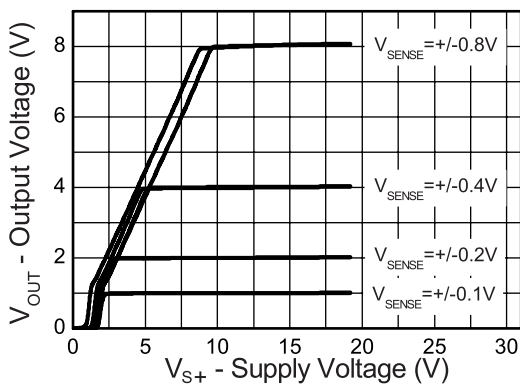

Output v Supply Voltage

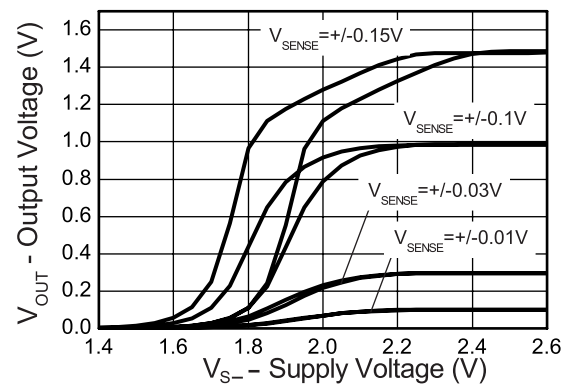

Output v Supply Voltage

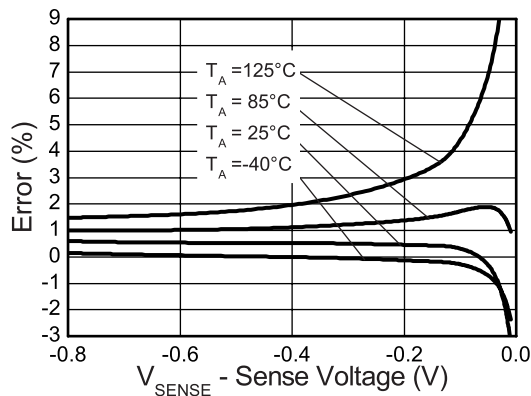

Error v Reverse Sense Voltage

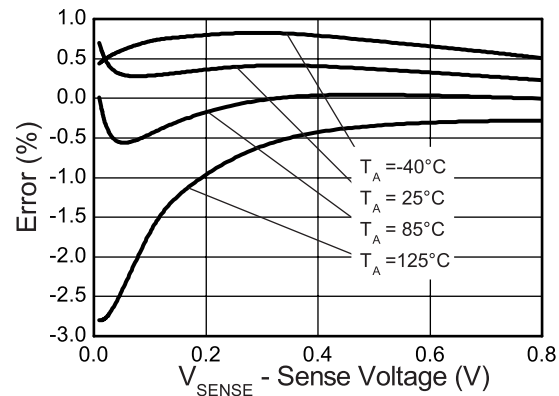

Error v Forward Sense Voltage

## Typical characteristics

Conditions  $V_{SENSE+}=10V$ ,  $V_{SENSE}=100mV$ ,  $T_A=25^\circ C$  unless otherwise stated.

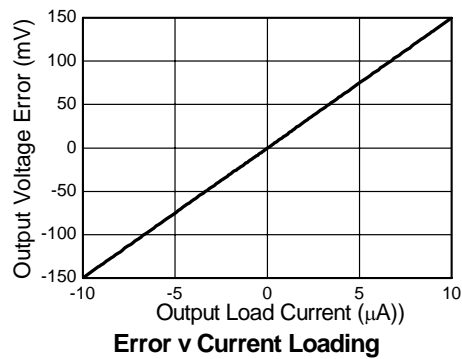
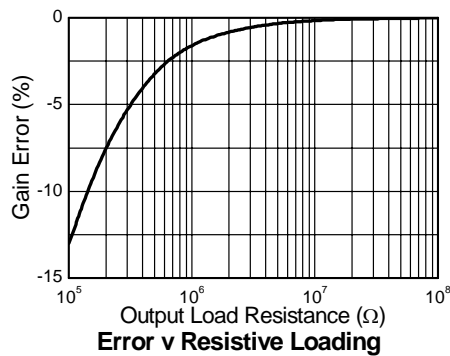
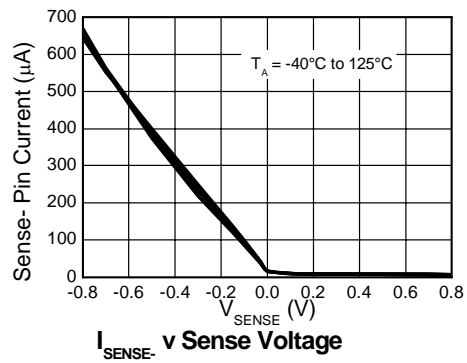
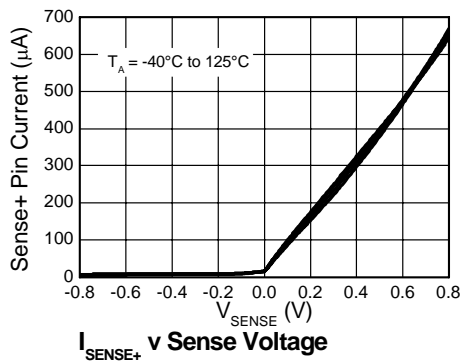
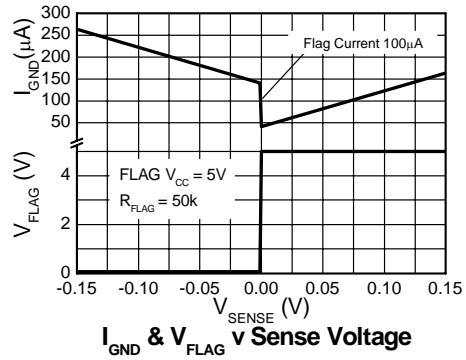
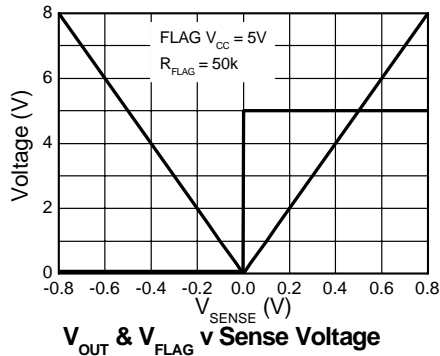

## Typical characteristics

Conditions  $V_{SENSE+}=10V$ ,  $V_{SENSE}=100mV$ ,  $T_A=25^{\circ}C$  unless otherwise stated.

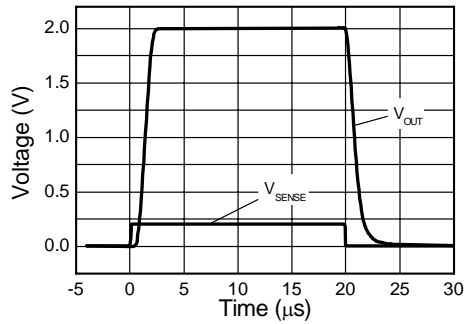

**Forward Large Signal Step Response**

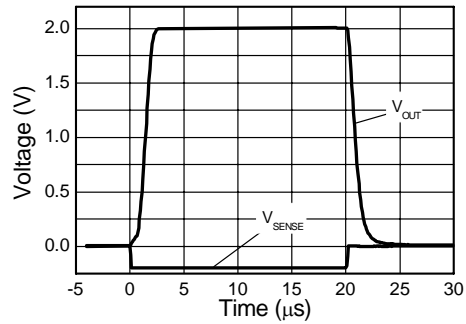

**Reverse Large Signal Step Response**

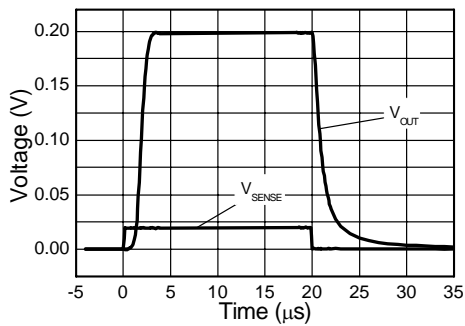

**Forward Small Signal Step Response**

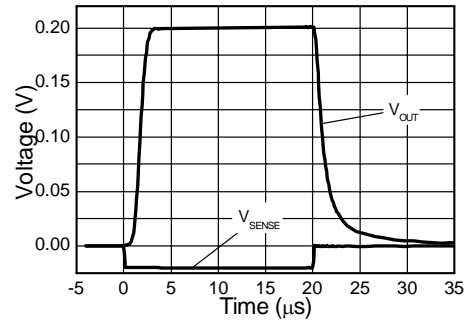

**Reverse Small Signal Step Response**

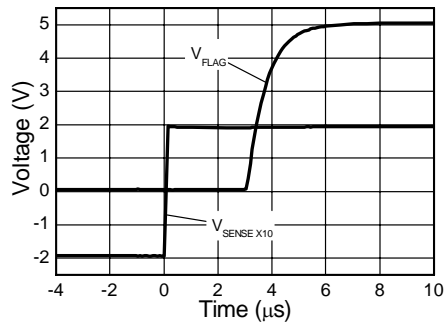

**Large Sig Zero Crossing Response**

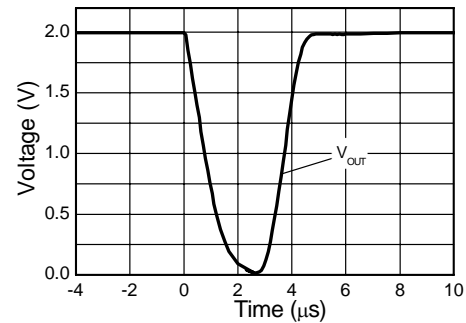

**Large Sig Zero Crossing Response**

## Typical characteristics

Conditions  $V_{SENSE+}=10V$ ,  $V_{SENSE}=100mV$ ,  $T_A=25^{\circ}C$  unless otherwise stated.

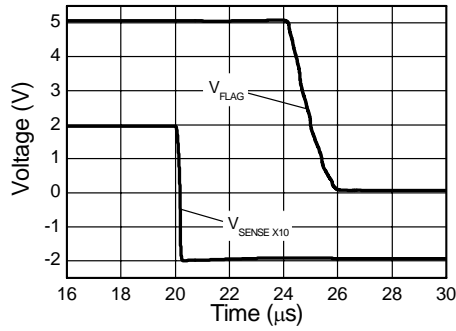

**Large Sig Zero Crossing Response**

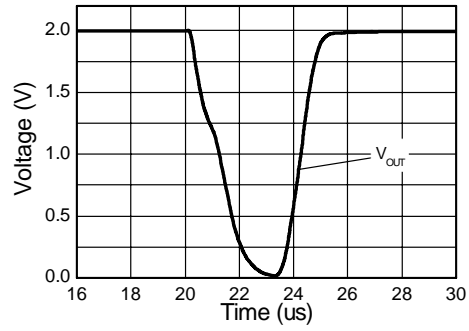

**Large Sig Zero Crossing Response**

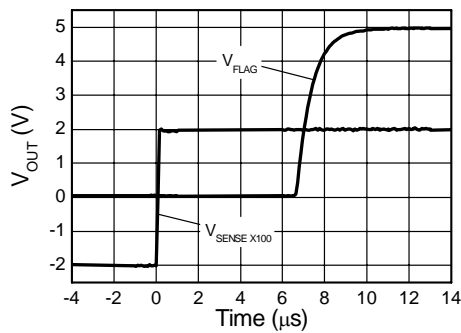

**Small Sig Zero Crossing Response**

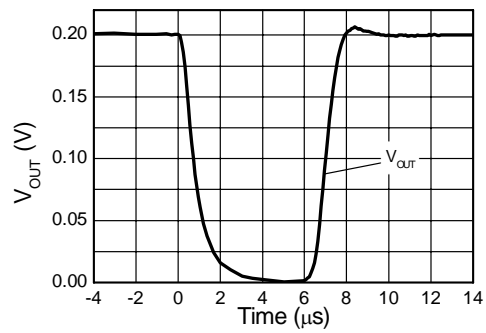

**Small Sig Zero Crossing Response**

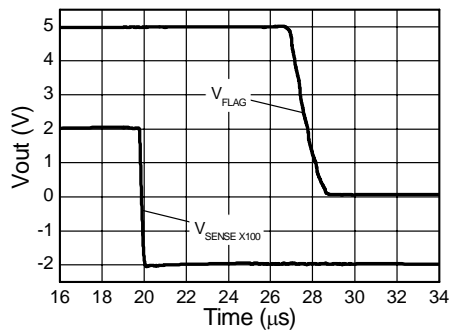

**Small Sig Zero Crossing Response**

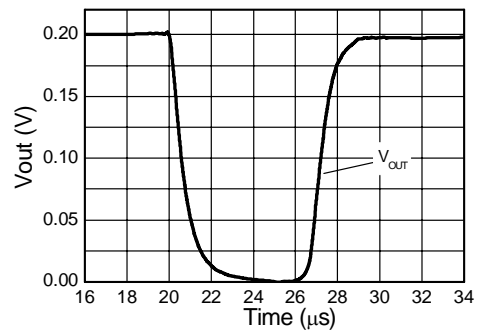

**Small Sig Zero Crossing Response**

## Typical characteristics

Conditions  $V_{SENSE+}=10V$ ,  $V_{SENSE}=100mV$ ,  $T_A=25^{\circ}C$  unless otherwise stated.

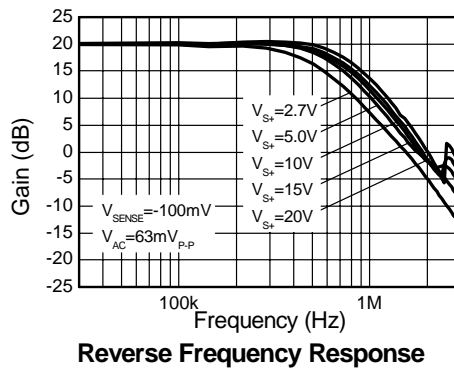
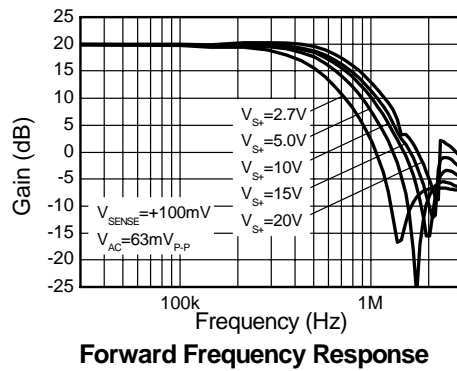
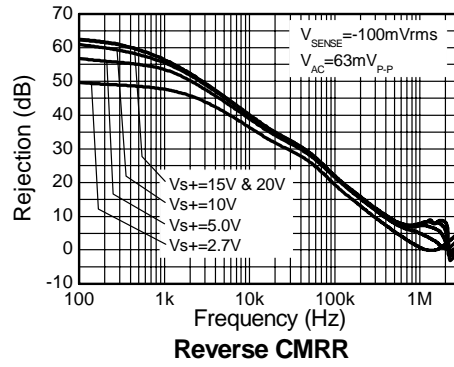
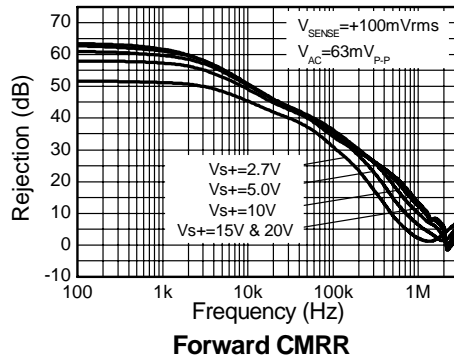



# ZXCT1041

## Application information

The ZXCT1041 uses two current monitors in anti-parallel to provide bidirectional current measurement. The integrated resistors while having a broad actual value variance provide very good matching to one another; this provides very tight gain matching from forward current measurement to reverse current management and removes the need to trim the resistor values.

The internal transconductance setting resistors have a nominal value of  $1.5k\Omega$  thereby setting the internal transconductance to  $0.67mA/V$  of  $V_{SENSE}$ . The outputs of both current monitors (current) are summed into an internal common gain-setting resistor of  $15k\Omega$ . This sets the overall gain to 10 which has a very small variance due to the very good matching of internal transistors.

To improve accuracy the offset of amplifier 1 is trimmed.

The direction of measured current flow is determined by comparing the voltages applied to the bases of transconductance transistors (Q1 and Q2). For maximum versatility the flag output uses an open collector; this allows the ZXCT1041 to monitor rails at a much higher potential than what the flag output is interfacing to.

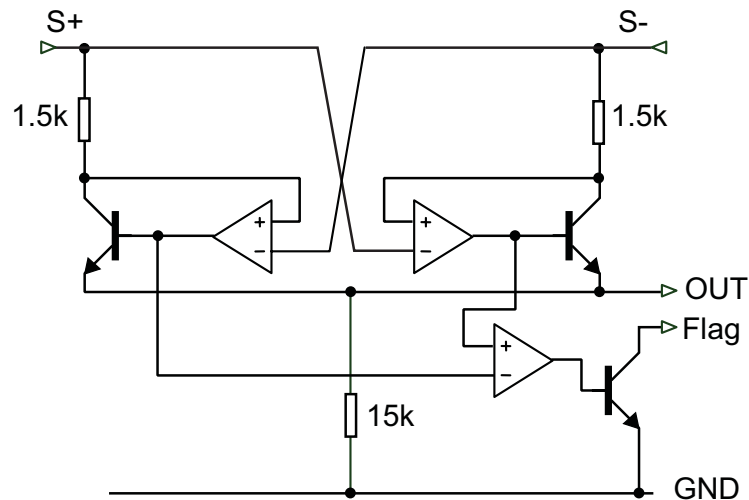

A common application for micro-power current monitors is measuring the discharge current of a rechargeable lithium ion/polymer battery. The ZXCT1041 enables measuring both the charge and discharge current into the battery and with its wide operating voltage of 2.5 to 20V enables it to measure the currents in to/ out of up to 4 cells connected in series.

# ZXCT1041

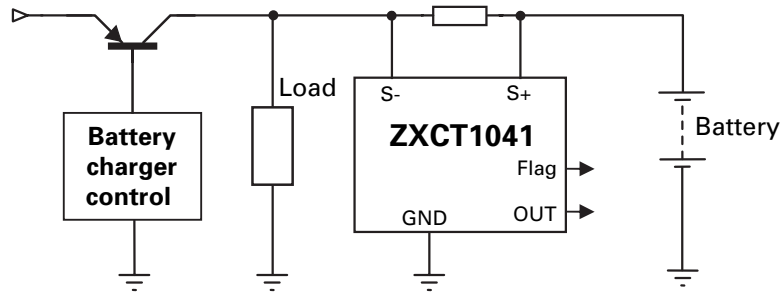

When choosing appropriate values for  $R_{SENSE}$  a compromise must be reached between in-line signal loss (including potential power dissipation effects) and small signal accuracy.

Higher values for  $R_{SENSE}$  gives better accuracy at low load currents by reducing the inaccuracies due to internal offsets. For best operation the ZXCT1041 has been designed to operate with  $V_{SENSE}$  of the order of 50mV to 150mV.

# ZXCT1041

## Package outline - SOT23-5

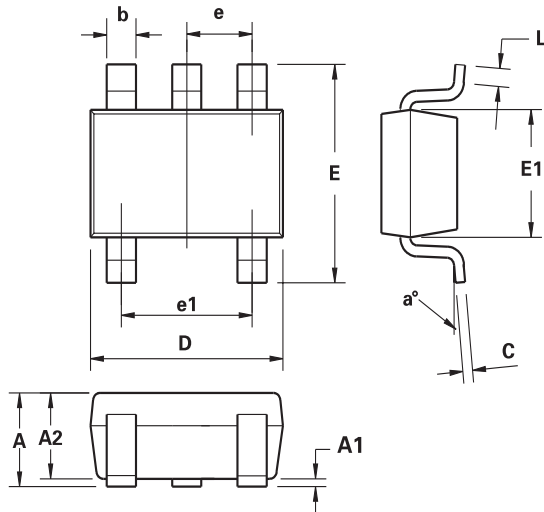

| DIM | Millimeters |      | Inches     |        |
|-----|-------------|------|------------|--------|
|     | Min.        | Max. | Min.       | Max.   |
| A   | 0.90        | 1.45 | 0.0354     | 0.0570 |
| A1  | 0.00        | 0.15 | 0.00       | 0.0059 |
| A2  | 0.90        | 1.30 | 0.0354     | 0.0511 |
| b   | 0.20        | 0.50 | 0.0078     | 0.0196 |
| C   | 0.09        | 0.26 | 0.0035     | 0.0102 |
| D   | 2.70        | 3.10 | 0.1062     | 0.1220 |
| E   | 2.20        | 3.20 | 0.0866     | 0.1181 |
| E1  | 1.30        | 1.80 | 0.0511     | 0.0708 |
| e   | 0.95 REF    |      | 0.0374 REF |        |
| e1  | 1.90 REF    |      | 0.0748 REF |        |
| L   | 0.10        | 0.60 | 0.0039     | 0.0236 |
| a°  | 0°          | 30°  | 0°         | 30°    |

**Note:** Controlling dimensions are in millimeters. Approximate dimensions are provided in inches

## Definitions

### Product change

Zetex Semiconductors reserves the right to alter, without notice, specifications, design, price or conditions of supply of any product or service. Customers are solely responsible for obtaining the latest relevant information before placing orders.

### Applications disclaimer

The circuits in this design/application note are offered as design ideas. It is the responsibility of the user to ensure that the circuit is fit for the user's application and meets with the user's requirements. No representation or warranty is given and no liability whatsoever is assumed by Zetex with respect to the accuracy or use of such information, or infringement of patents or other intellectual property rights arising from such use or otherwise. Zetex does not assume any legal responsibility or will not be held legally liable (whether in contract, tort (including negligence), breach of statutory duty, restriction or otherwise) for any damages, loss of profit, business, contract, opportunity or consequential loss in the use of these circuit applications, under any circumstances.

### Life support

Zetex products are specifically not authorized for use as critical components in life support devices or systems without the express written approval of the Chief Executive Officer of Zetex Semiconductors plc. As used herein:

A. Life support devices or systems are devices or systems which:

1. are intended to implant into the body

or

2. support or sustain life and whose failure to perform when properly used in accordance with instructions for use provided in the labelling can be reasonably expected to result in significant injury to the user.

B. A critical component is any component in a life support device or system whose failure to perform can be reasonably expected to cause the failure of the life support device or to affect its safety or effectiveness.

### Reproduction

The product specifications contained in this publication are issued to provide outline information only which (unless agreed by the company in writing) may not be used, applied or reproduced for any purpose or form part of any order or contract or be regarded as a representation relating to the products or services concerned.

### Terms and Conditions

All products are sold subjects to Zetex' terms and conditions of sale, and this disclaimer (save in the event of a conflict between the two when the terms of the contract shall prevail) according to region, supplied at the time of order acknowledgement.

For the latest information on technology, delivery terms and conditions and prices, please contact your nearest Zetex sales office.

### Quality of product

Zetex is an ISO 9001 and TS16949 certified semiconductor manufacturer.

To ensure quality of service and products we strongly advise the purchase of parts directly from Zetex Semiconductors or one of our regionally authorized distributors. For a complete listing of authorized distributors please visit: [www.zetex.com/salesnetwork](http://www.zetex.com/salesnetwork)

Zetex Semiconductors does not warrant or accept any liability whatsoever in respect of any parts purchased through unauthorized sales channels.

### ESD (Electrostatic discharge)

Semiconductor devices are susceptible to damage by ESD. Suitable precautions should be taken when handling and transporting devices. The possible damage to devices depends on the circumstances of the handling and transporting, and the nature of the device. The extent of damage can vary from immediate functional or parametric malfunction to degradation of function or performance in use over time. Devices suspected of being affected should be replaced.

### Green compliance

Zetex Semiconductors is committed to environmental excellence in all aspects of its operations which includes meeting or exceeding regulatory requirements with respect to the use of hazardous substances. Numerous successful programs have been implemented to reduce the use of hazardous substances and/or emissions.

All Zetex components are compliant with the RoHS directive, and through this it is supporting its customers in their compliance with WEEE and ELV directives.

### Product status key:

|                                   |  |
|-----------------------------------|--|
| "Preview"                         | Future device intended for production at some point. Samples may be available  |
| "Active"                          | Product status recommended for new designs                                     |
| "Last time buy (LTB)"             | Device will be discontinued and last time buy period and delivery is in effect |
| "Not recommended for new designs" | Device is still in production to support existing designs and production       |
| "Obsolete"                        | Production has been discontinued   |

### Datasheet status key:

|                       |   |
|-----------------------|---|
| "Draft version"       | This term denotes a very early datasheet version and contains highly provisional information, which may change in any manner without notice.  |
| "Provisional version" | This term denotes a pre-release datasheet. It provides a clear indication of anticipated performance. However, changes to the test conditions and specifications may occur, at any time and without notice. |
| "Issue"               | This term denotes an issued datasheet containing finalized specifications. However, changes to specifications may occur, at any time and without notice.  |

### Zetex sales offices

| Europe  | Americas  | Asia Pacific   | Corporate Headquarters   |
|---|---|--|--|
| Zetex GmbH<br>Kustermann-park<br>Balansstraße 59<br>D-81541 München<br>Germany<br>Telefon: (49) 89 45 49 49 0<br>Fax: (49) 89 45 49 49 49<br>europe.sales@zetex.com | Zetex Inc<br>700 Veterans Memorial Highway<br>Hauppauge, NY 11788<br>USA<br>Telephone: (1) 631 360 2222<br>Fax: (1) 631 360 8222<br>usa.sales@zetex.com | Zetex (Asia Ltd)<br>3701-04 Metroplaza Tower 1<br>Hing Fong Road, Kwai Fong<br>Hong Kong<br>Telephone: (852) 26100 611<br>Fax: (852) 24250 494<br>asia.sales@zetex.com | Zetex Semiconductors plc<br>Zetex Technology Park, Chadderton<br>Oldham, OL9 9LL<br>United Kingdom<br>Telephone: (44) 161 622 4444<br>Fax: (44) 161 622 4446<br>hq@zetex.com |

© 2008 Published by Zetex Semiconductors plc