

Battery Switch with Four Enable Inputs

General Description

The MAX14525 features a low R_{ON} 35m Ω (typ) load switch with four unique enable inputs. The MAX14525 is ideal for disconnecting the lithium-ion (Li+) battery from the loads in portable devices such as cell phones. The MAX14525 operates from a +2.2V to +5.5V supply voltage.

The MAX14525 features an extremely low 0.8 μ A (typ) quiescent supply current to maximize battery life in portable devices. It is enabled from four possible inputs: external charger connection capable of high voltage up to +28V, travel adapter (TA), on key (ON_K), factory mode enable (JIG), and switch enable (S_EN). The S_EN input is internally ANDed with the switched battery connection (IN).

The MAX14525 is available in a small 8-pin, 2mm x 2mm TDFN package and operates over the -40°C to +85°C extended temperature range.

Applications

Cell Phones
PDAs
GPS
UMPC Computers
Digital Cameras

Features

- ◆ Low 35m Ω (typ) R_{ON} Load Switch
- ◆ Ultra Low, 0.8 μ A (typ) Supply Current
- ◆ Four Enable Inputs:
 - TA: +28V (max) Capable
 - ON_K: Accurate +3V Trigger Enable
 - JIG: Factory Mode Enable
 - S_EN: Logically ANDed with IN
- ◆ Space-Saving 8-Pin, 2mm x 2mm TDFN Package
- ◆ Controlled Turn-On to Limit di/dt Pulses Due to Lead Inductance

Ordering Information

PART	PIN-PACKAGE	TOP MARK
MAX14525ETA+T	8 TDFN-EP*	ACQ

Note: The device is specified over the -40°C to +85°C operating temperature range.

+Denotes a lead-free/RoHS-compliant package.

*EP = Exposed pad.

Typical Application Circuit

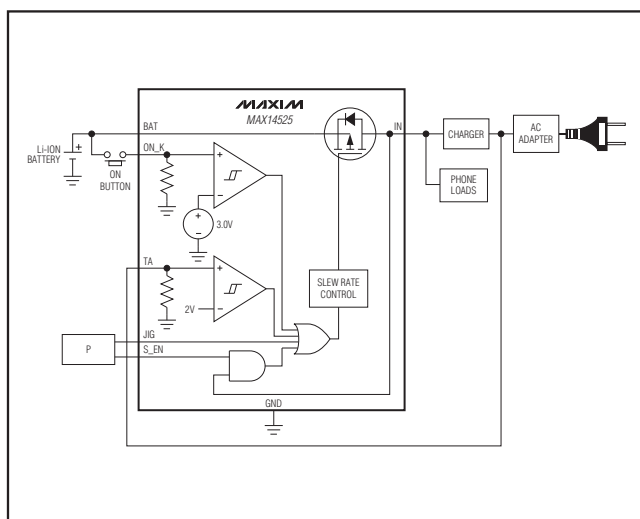

Pin Configuration

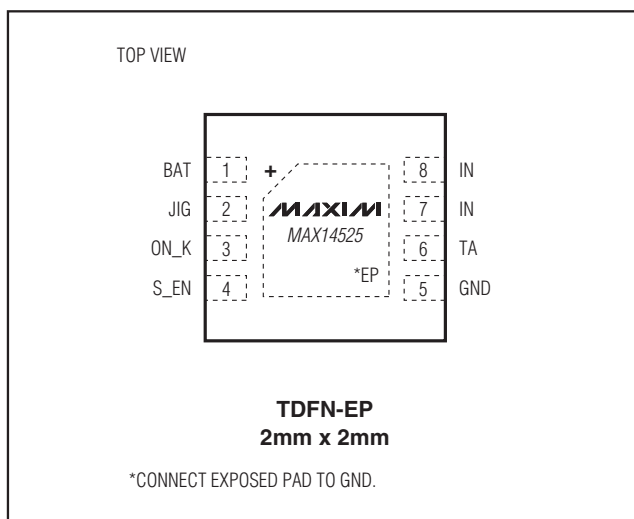

Battery Switch with Four Enable Inputs

ABSOLUTE MAXIMUM RATINGS

(All voltages referenced to GND.)

IN, BAT, JIG, S_EN, ON_K	-0.3V to +6.0V
TA	-0.3V to +28V
Continuous Power Dissipation (TA = +70°C)	
8-Pin TDFN (derate 11.9 mW/°C above +70°C)	954 mW
Junction-to-Case Thermal Resistance (θJC) (Note 1)	37°C/W

Junction-to-Ambient Thermal Resistance

(θJA) (Note 1)	84°C/W
Operating Temperature Range	-40°C to +85°C
Junction Temperature	+150°C
Storage Temperature Range	-65°C to +150°C
Lead Temperature (soldering, 10s)	+300°C

Note 1: Package thermal resistances were obtained using the method described in JEDEC specification JESD51-7, using a four-layer board. For detailed information on package thermal considerations, refer to www.maxim-ic.com/thermal-tutorial.

Stresses beyond those listed under "Absolute Maximum Ratings" may cause permanent damage to the device. These are stress ratings only, and functional operation of the device at these or any other conditions beyond those indicated in the operational sections of the specifications is not implied. Exposure to absolute maximum rating conditions for extended periods may affect device reliability.

ELECTRICAL CHARACTERISTICS

(VBAT = +2.2V to +5.5V, TA = -40°C to +85°C, unless otherwise noted. Typical values are at VBAT = +3.6V and TA = +25°C.) (Note 2)

PARAMETER	SYMBOL	CONDITIONS	MIN	TYP	MAX	UNITS
DC CHARACTERISTICS						
Input Voltage Range	VBAT, VIN		2.2		5.5	V
On-Resistance	RON	ILOAD = 100mA, VBAT = +3.0V		35	90	mΩ
Disable Supply Current	IBAT_DIS	VBAT = +5.5V (VJIG = VS_EN = VON_K = VTA = VIN = 0)			1	μA
VBAT Supply Current	IBAT	VJIG = VS_EN = VBAT, VON_K = VTA = 0		0.8	4.5	μA
Increase in Supply Current with VJIG/VS_EN Voltage	ΔIBAT	VJIG = VS_EN = VIH or VIL			2	μA
Increase in Supply Current with VON_K Voltage	ΔIBAT	VBAT = VON_K = +3.6V			4.5	μA
Peak Current	ILIM	VBAT = +3.6V	5			A
UVLO Undervoltage Lockout		Ramping VBAT			1.9	V
LOGIC INPUT						
TA Threshold Voltage	VTA_TH		1.15	1.7	2.5	V
TA Threshold Hysteresis				1%		
TA Input Resistance		VTA = 1V	50	100	180	kΩ
JIG, S_EN Input Logic-High	VIH		1.4			V
JIG, S_EN Input Logic-Low	VIL				0.4	V
JIG, S_EN Input Leakage Current	IIN	VBAT = +5.5V	-200		+200	nA
IN AND Gate Threshold Voltage	VIN_TH		0.3 x VBAT		0.6 x VBAT	V
ON_K Threshold Voltage	VON_K_TH	Low-to-high transition (Figure 1)	2.94	3.0	3.06	V
ON_K Threshold Hysteresis				1%		

Battery Switch with Four Enable Inputs

ELECTRICAL CHARACTERISTICS (continued)

($V_{BAT} = +2.2V$ to $+5.5V$, $T_A = -40^\circ C$ to $+85^\circ C$, unless otherwise noted. Typical values are at $V_{BAT} = +3.6V$ and $T_A = +25^\circ C$.) (Note 2)

PARAMETER	SYMBOL	CONDITIONS	MIN	TYP	MAX	UNITS
ON_K Input Leakage Current	I_{ON_K}	$V_{BAT} = V_{ON_K} = +3.6V$			3	μA
SWITCH DYNAMICS ($R_L = 20\Omega$, $C_L = 0.1\mu F$) (Figure 2)						
Turn-On Delay Time	t_{ON_DLY}	From any enable high to $V_{IN} = 10\%$ of V_{BAT}		600	2600	μs
Turn-On Rise Time	t_{ON_RISE}	V_{IN} 10% to 90% of V_{BAT}	500	1800	5000	μs
Turn-Off Delay Time	t_{OFF_DLY}	From any enable low to $V_{IN} = 90\%$ of V_{BAT}		130	300	μs
Turn-Off Fall Time	t_{OFF_FALL}	V_{IN} 90% to 10% of V_{BAT}		60	150	μs

Note 2: Devices are tested at $T_A = +25^\circ C$. Specifications over temperature are guaranteed by design.

Typical Operating Characteristics

($V_{IN} = +3.6V$, $T_A = +25^\circ C$, unless otherwise noted.)

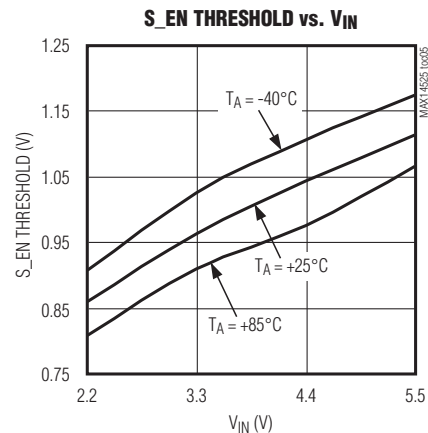
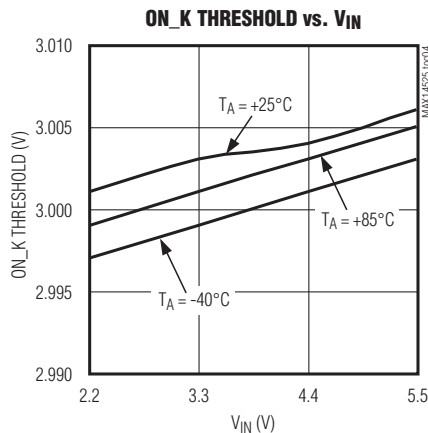
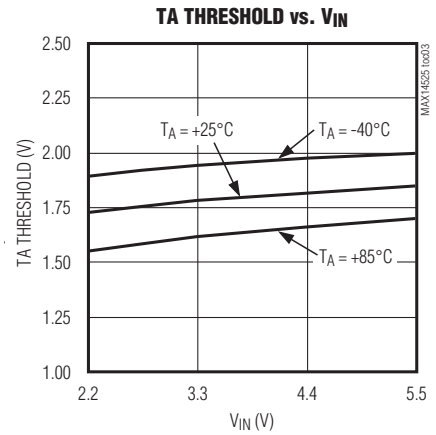
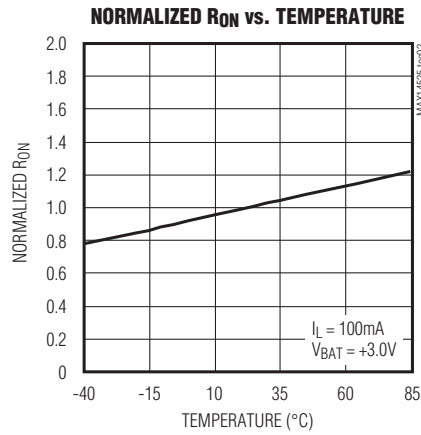
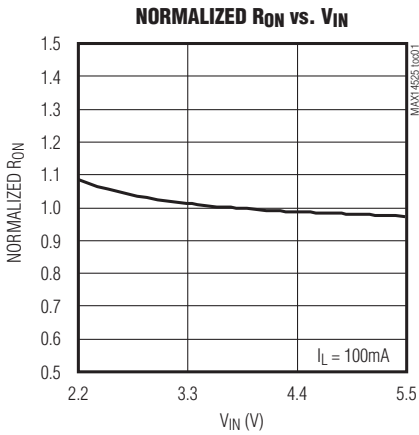

Battery Switch with Four Enable Inputs

Typical Operating Characteristics (continued)

($V_{IN} = +3.6V$, $T_A = +25^\circ C$, unless otherwise noted.)

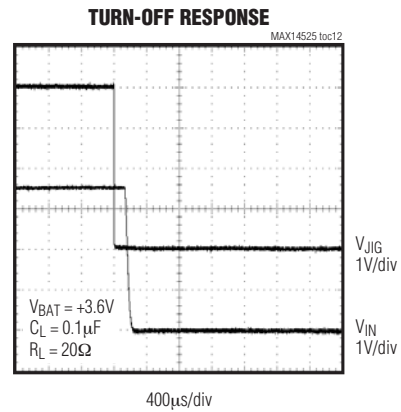
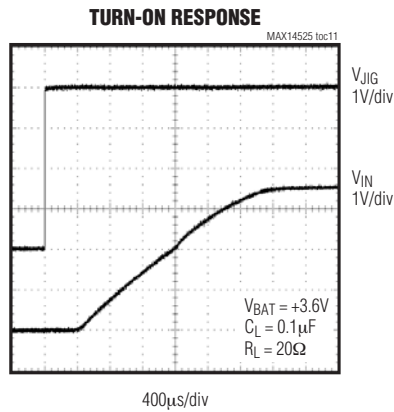
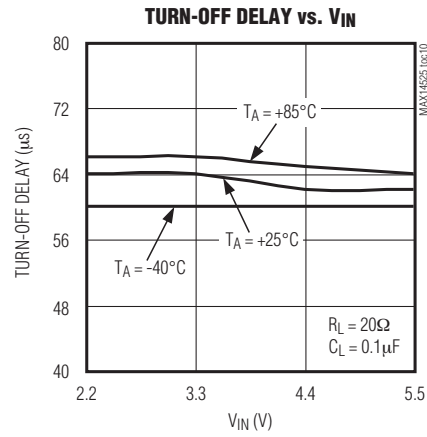
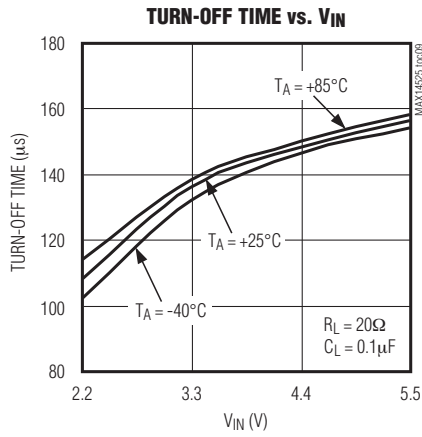
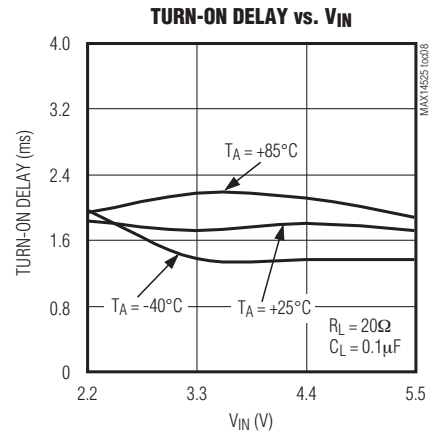
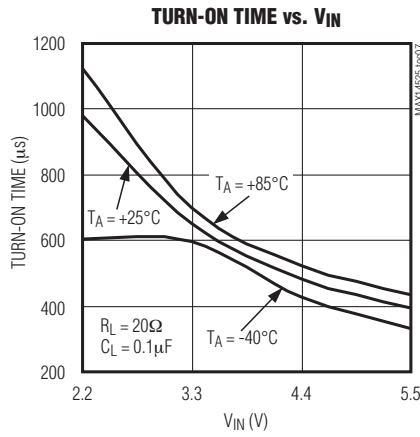
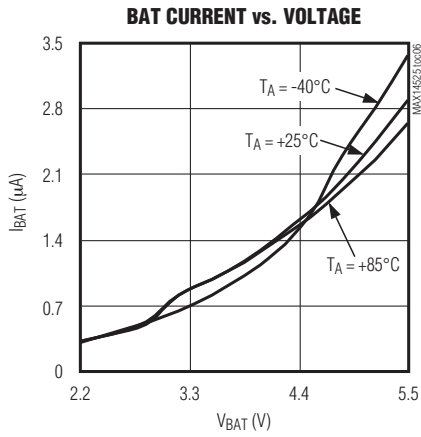

Battery Switch with Four Enable Inputs

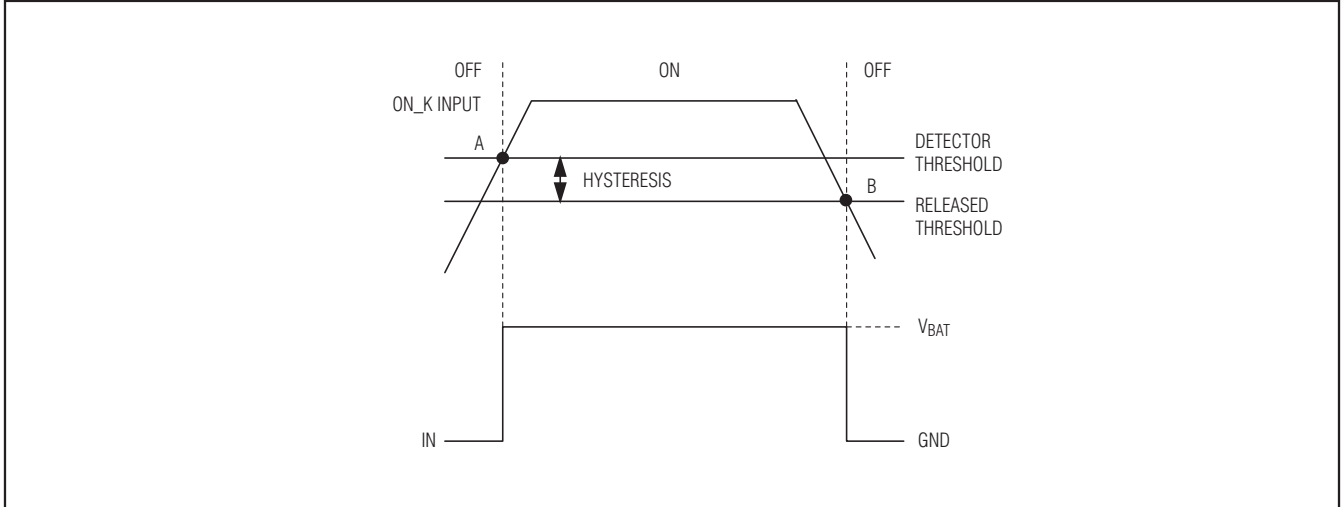

Figure 1. ON_K Input Operation Diagram

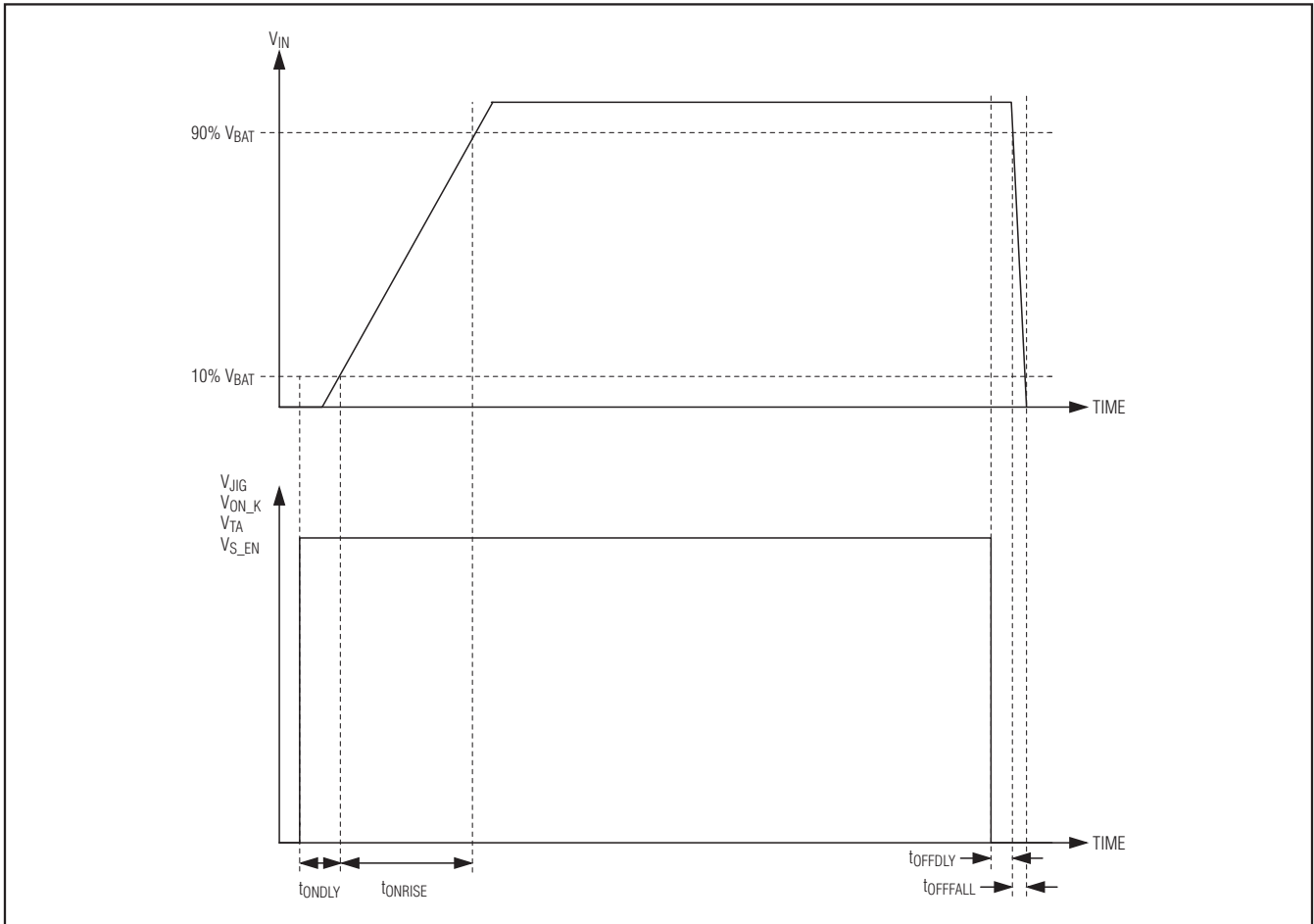

Figure 2. Turn-On Delay Time, Turn-On Rise Time, Turn-Off Delay Time, and Turn-Off Fall Time

Battery Switch with Four Enable Inputs

Pin Description

PIN	NAME	FUNCTION
1	BAT	Lithium-Ion (Li+) Battery Connection
2	JIG	Enable Input with Standard Logic Threshold
3	ON_K	Enable Input with Accurate Threshold (+3.0V)
4	S_EN	Enable Input with Standard Logic Threshold Logically ANDed with IN
5	GND	Ground
6	TA	Enable Input with High Threshold
7, 8	IN	Power Switch Input. The power switch input voltage range is from +2.2V to +5.5V. Connect a 0.1 μ F capacitor from IN to GND. Connect pins 7 and 8 together for proper operation.
—	EP	Exposed Pad. Connect EP to ground. Do not use EP as the only ground connection.

Detailed Description

The MAX14525 features a low 35m Ω (typ) R_{ON} load switch with four unique enable inputs. The MAX14525 can be used to disconnect the lithium-ion battery from the loads in portable devices such as cell phones. It operates from a +2.2V to +5.5V supply voltage.

The MAX14525 features an ultra-low 0.8 μ A (typ) quiescent supply current to maximize battery life in portable devices. The device is enabled from four possible inputs: external charge connection travel adapter (TA), on key (ON_K), factory mode enable (JIG), and switch enable (S_EN). The S_EN input is internally ANDed with the switched battery connection (IN).

TA Input

The TA input on the MAX14525 can be connected directly to the external charger source. The TA input is high-voltage capable (+28V max) and features a high threshold voltage to limit false voltage trips, and an input resistance of 100k Ω (typ) to ground.

ON_K Input

The ON_K line is active high and is pulled up to the lithium-ion battery through a momentary push button switch. This input features an accurate voltage detector threshold which does not enable the load switch

until the battery threshold is above +3.0V \pm 2%. When the battery has a very low charge and the on key is pressed, the accurate threshold does not allow the phone to boot up.

JIG Input

The JIG input on the MAX14525 is a logic-level input (+1.8V compatible) from an external source to indicate the device has been connected to a factory cable. This signal requires a standard logic-input threshold voltage (+1.4V high).

S_EN Input

The S_EN input on the MAX14525 is a logic-level input (+1.8V compatible) from an external source used to hold the switch on when the triggering condition (TA, ON_K, or JIG) is removed. The standard logic threshold voltage comes from the host microprocessor that pulls S_EN high once the code has begun running on the microprocessor. The S_EN input is internally ANDed with the voltage on IN. The IN connection to the AND gate thresholds are standard CMOS values of 1/3 and 2/3 of V_{BAT}.

Chip Information

PROCESS: CMOS

Battery Switch with Four Enable Inputs

Package Information

For the latest package outline information and land patterns, go to www.maxim-ic.com/packages.

PACKAGE TYPE	PACKAGE CODE	DOCUMENT NO.
8 TDFN-EP	T822+2	21-0168

MAX14525

Maxim cannot assume responsibility for use of any circuitry other than circuitry entirely embodied in a Maxim product. No circuit patent licenses are implied. Maxim reserves the right to change the circuitry and specifications without notice at any time.

Maxim Integrated Products, 120 San Gabriel Drive, Sunnyvale, CA 94086 408-737-7600 _____ 7

© 2008 Maxim Integrated Products

MAXIM is a registered trademark of Maxim Integrated Products, Inc.