

Lithium-Ion Linear Battery Charger Controller

FEATURES

- Complete Linear Charger Controller for 2-Cell Lithium-Ion Batteries
- Preset Charge Voltage with $\pm 1\%$ Accuracy
- Programmable Charge Current
- C/10 Charge Current Detection Output
- Programmable Charge Termination Timer
- Small, Thin 10-Pin MSOP Package
- Input Supply (Wall Adapter) Detection Output
- 8.8V to 12V Input Voltage Range
- Automatic Sleep Mode When Input Supply Is Removed (Only 10 μ A Battery Drain)
- Automatic Trickle Charging of Low Voltage Cells
- Programmable for Constant-Current-Only Mode
- Battery Insertion Detect and Automatic Charging of Low-Battery
- Automatic Battery Recharge

APPLICATIONS

- Cellular Phones
- Handheld Computers
- Charging Docks and Cradles
- Digital Cameras and Camcorders

 LTC and LT are registered trademarks of Linear Technology Corporation.

DESCRIPTION

The LTC[®]1732-8.4 is a complete constant-current/constant-voltage linear charge controller for lithium-ion (Li-Ion) batteries. Nickel-cadmium (NiCd) and nickel metal-hydride (NiMH) batteries can also be charged with constant current using external termination. Charge current can be programmed with $\pm 7\%$ accuracy using external sense and program resistors. An internal resistor divider and precision reference set the final float voltage with $\pm 1\%$ accuracy.

When the input supply is removed, the LTC1732-8.4 automatically enters a low current sleep mode, dropping the battery drain current to 10 μ A. An internal comparator detects the end-of-charge (C/10) condition while a programmable timer, using an external capacitor, sets the total charge time. Fully discharged cells are automatically trickle charged at 10% of the programmed current until battery voltage exceeds 4.9V.

The LTC1732-8.4 begins a new charge cycle when a discharged battery is connected to the charger or when the input power is applied. In addition, if the battery remains connected to the charger and the cell voltage drops below 8.05V, a new charge cycle will begin.

The LTC1732-8.4 is available in the 10-pin MSOP package.

TYPICAL APPLICATION

400mA 2-Cell 8.4V Li-Ion Battery Charger

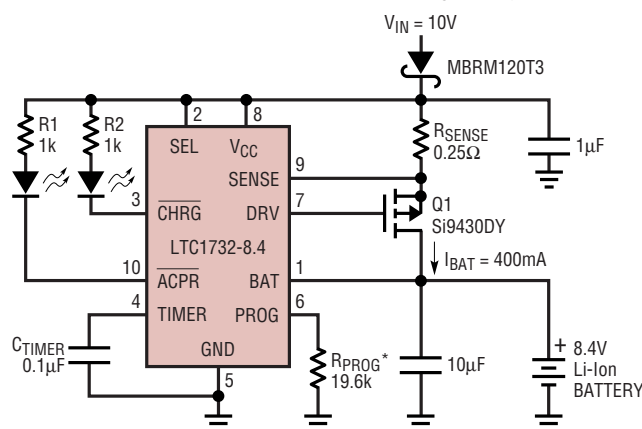

*SHUTDOWN INVOKED BY FLOATING THE PROG PIN

1732-8.4 TA01

Typical Li-Ion Charge Cycle

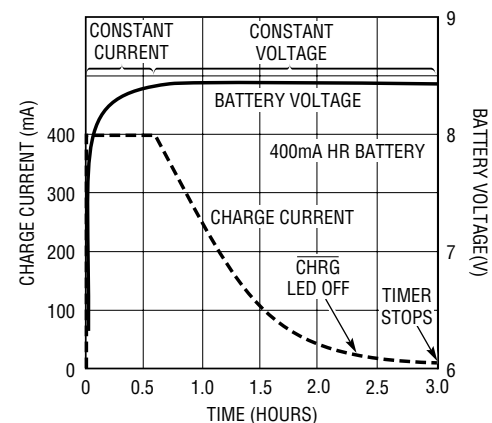

1732-8.4 TA01b

ABSOLUTE MAXIMUM RATINGS

(Note 1)

Input Supply Voltage (V_{CC})	13.2V
SENSE, DRV, BAT, SEL, TIMER, PROG, CHRG, ACPR	-0.3V to 13.2V
Operating Temperature Range (Note 2)	-40° to 85°C
Storage Temperature Range	-65°C to 150°C
Lead Temperature (Soldering, 10 sec)	300°C

PACKAGE/ORDER INFORMATION

<p>MS10 PACKAGE 10-LEAD PLASTIC MSOP $T_{JMAX} = 140^{\circ}C$, $\theta_{JA} = 180^{\circ}C/W$</p>	ORDER PART NUMBER
	LTC1732EMS-8.4
	MS10 PART MARKING
	LTWW

Consult LTC Marketing for parts specified with wider operating temperature ranges.

ELECTRICAL CHARACTERISTICS

The ● denotes the specifications which apply over the full operating temperature range, otherwise specifications are at $T_A = 25^{\circ}C$. $V_{CC} = 9V$ unless otherwise noted.

SYMBOL	PARAMETER	CONDITIONS	MIN	TYP	MAX	UNITS	
V_{CC}	Input Supply Voltage		● 8.8		12	V	
I_{CC}	Input Supply Current	Charger On, Current Mode	●	1	3	mA	
		Shutdown Mode	●	1	3	mA	
		Sleep Mode (Battery Drain Current)		10	30	μA	
V_{BAT}	Regulated Output Float Voltage	$9V \leq V_{CC} \leq 12V$, $V_{SEL} = V_{CC}$	● 8.316	8.4	8.484	V	
I_{BAT}	Current Mode Charge Current	$R_{PROG} = 19.6k$, $R_{SENSE} = 0.2\Omega$		465	500	535	mA
		$R_{PROG} = 19.6k$, $R_{SENSE} = 0.2\Omega$	●	415		585	mA
		$R_{PROG} = 97.6k$, $R_{SENSE} = 0.2\Omega$		60	100	140	mA
I_{TRIKL}	Trickle Charge Current	$V_{BAT} = 4V$, $R_{PROG} = 19.6k$, $I_{TRIKL} = (V_{CC} - V_{SENSE})/0.2\Omega$	●	30	50	125	mA
V_{TRIKL}	Trickle Charge Threshold Voltage	From Low to High	●	4.7	4.9	5.1	V
V_{UV}	V_{CC} Undervoltage Lockout Voltage	From Low to High	●	8.2	8.7		V
ΔV_{UV}	V_{CC} Undervoltage Lockout Hysteresis			400		mV	
V_{MSD}	Manual Shutdown Threshold Voltage	PROG Pin Low to High		2.457		V	
		PROG Pin High to Low		2.446		V	
V_{ASD}	Automatic Shutdown Threshold Voltage	$(V_{CC} - V_{BAT})$ High to Low		30	54	90	mV
		$(V_{CC} - V_{BAT})$ Low to High		40	69	100	mV
V_{DIS}	Voltage Mode Disable Threshold Voltage	$V_{DIS} = V_{CC} - V_{TIMER}$			0.4	V	
I_{PROG}	PROG Pin Current	Internal Pull-Up Current, No R_{PROG}		2.5		μA	
		PROG Pin Source Current, $\Delta V_{PROG} \leq 5mV$	●		300	μA	
V_{PROG}	PROG Pin Voltage	$R_{PROG} = 19.6k$		2.457		V	
V_{ACPR}	\overline{ACPR} Pin Output Low Voltage	$I_{ACPR} = 5mA$		0.6	1.2	V	
I_{CHRG}	\overline{CHRG} Pin Weak Pull-Down Current	$V_{CHRG} = 1V$		15	35	55	μA
V_{CHRG}	\overline{CHRG} Pin Output Low Voltage	$I_{CHRG} = 5mA$		0.6	1.2	V	
I_{DRV}	Drive Pin Current	$V_{DRV} = V_{CC} - 2V$		26		μA	

ELECTRICAL CHARACTERISTICS The ● denotes the specifications which apply over the full operating temperature range, otherwise specifications are at $T_A = 25^\circ\text{C}$. $V_{CC} = 9\text{V}$ unless otherwise noted.

SYMBOL	PARAMETER	CONDITIONS	MIN	TYP	MAX	UNITS
$I_{C/10}$	10% Charge Current Indication Level	$R_{\text{PROG}} = 19.6\text{k}$, $R_{\text{SENSE}} = 0.2\Omega$	● 25	50	100	mA
t_{TIMER}	TIMER Accuracy	$C_{\text{TIMER}} = 0.1\mu\text{F}$		10		%
V_{RECHRG}	Recharge Threshold Voltage	V_{BAT} from High to Low	7.85	8.05		V

Note 1: Absolute Maximum Ratings are those values beyond which the life of a device may be impaired.

Note 2: The LTC1732EMS-8.4 is guaranteed to meet performance specifications from 0°C to 70°C . Specifications over the -40°C to 85°C operating temperature range are assured by design, characterization and correlation with statistical process controls.

TYPICAL PERFORMANCE CHARACTERISTICS

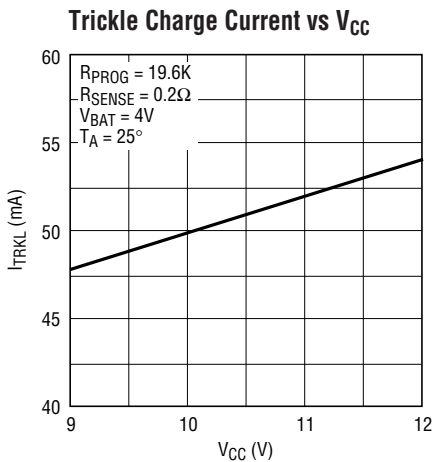

1732-8.4 G01

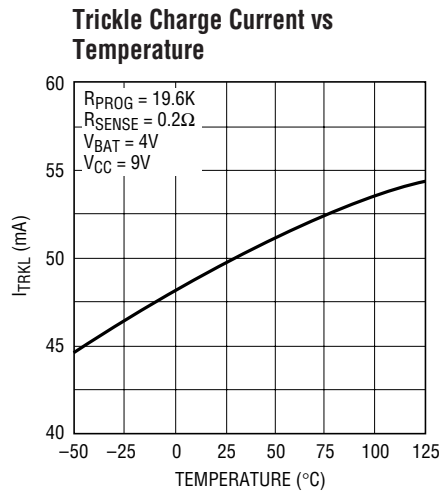

1732-8.4 G02

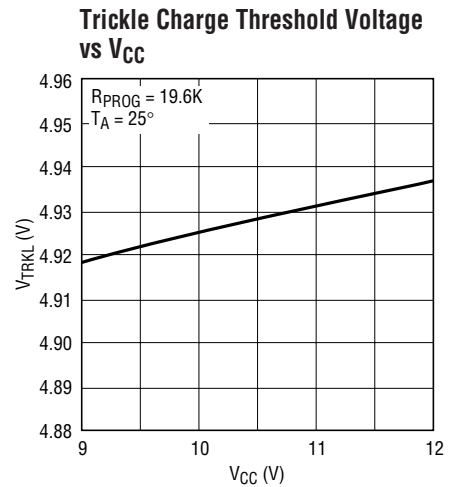

1732-8.4 G03

TYPICAL PERFORMANCE CHARACTERISTICS

Trickle Charge Threshold Voltage vs Temperature

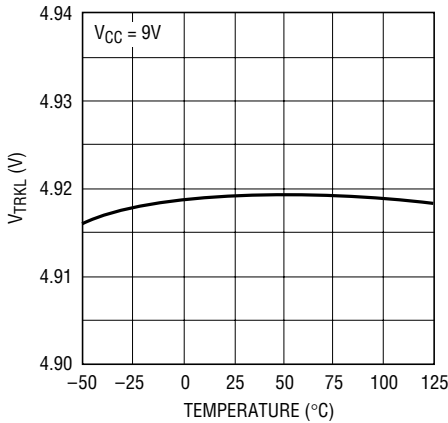

1732-8.4 G04

Timer Accuracy vs VCC

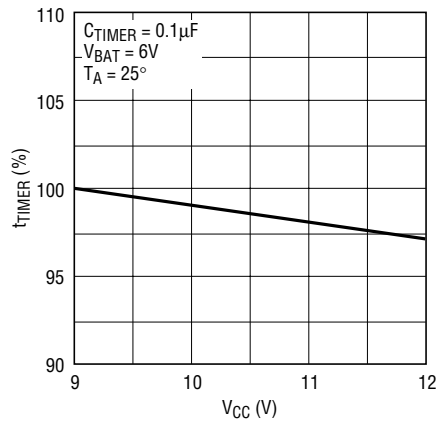

1732-8.4 G05

Timer Accuracy vs Temperature

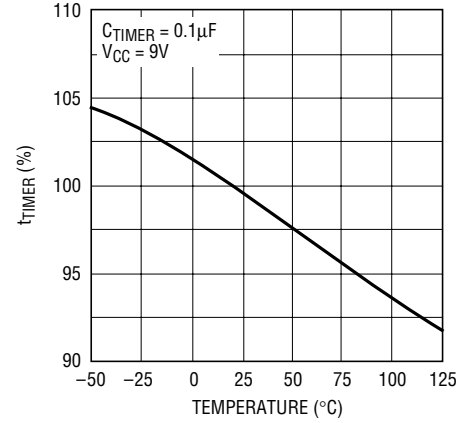

1732-8.4 G06

Battery Charge Current vs VCC

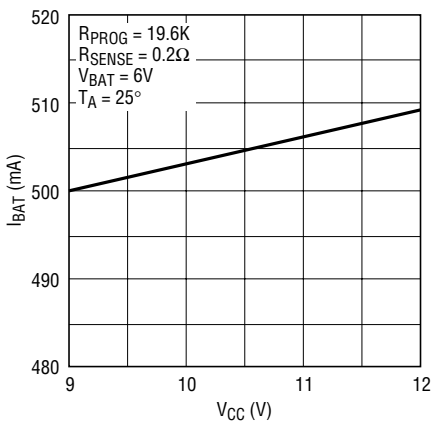

1732-8.4 G07

Battery Charge Current vs Temperature

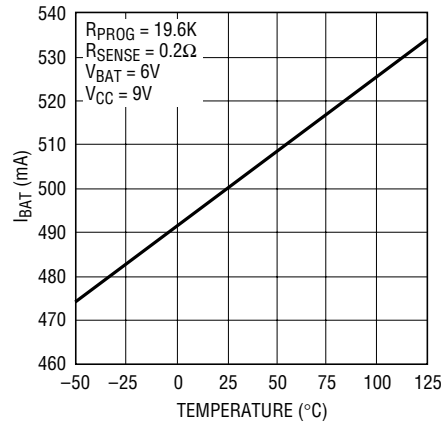

1732-8.4 G08

Program Pin Voltage vs VCC

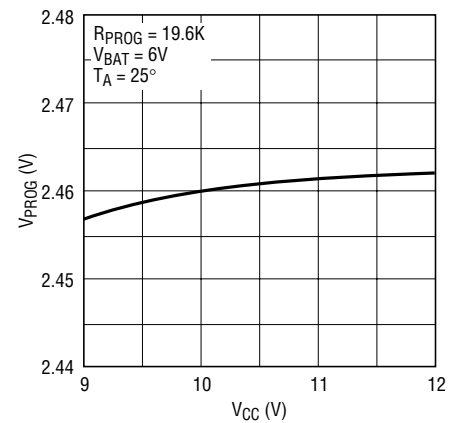

1732-8.4 G09

Program Pin Voltage vs Temperature

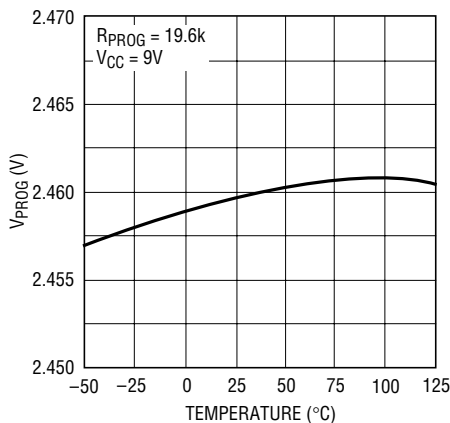

1732-8.4 G10

Recharge Threshold Voltage vs Temperature

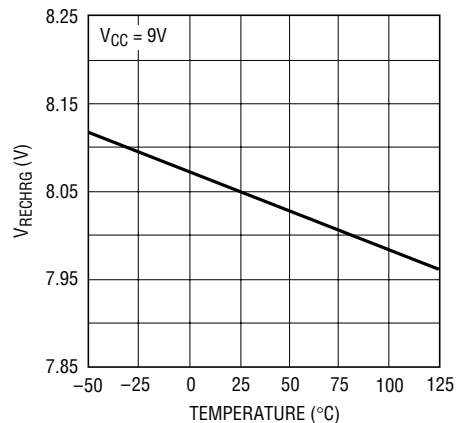

1732-8.4 G11

PIN FUNCTIONS

BAT (Pin 1): Battery Sense Input. A bypass capacitor of 10 μ F or more is required to keep the loop stable when the battery is not connected. A precision internal resistor divider sets the final float voltage. The resistor divider is disconnected in sleep mode to reduce the current drain on the battery.

SEL (Pin 2): This pin must be connected to V_{CC} .

CHRG (Pin 3): Open-Drain Charge Status Output. When the battery is charging, the $\overline{\text{CHRG}}$ pin is pulled low by an internal N-channel MOSFET. When the charge current drops to 10% of the full-scale current for more than 15ms, the N-channel MOSFET turns off and a 35 μ A current source is connected from the $\overline{\text{CHRG}}$ pin to GND. When the timer runs out or the input supply is removed, the current source is disconnected and the $\overline{\text{CHRG}}$ pin is forced into a high impedance state.

TIMER (Pin 4): Timer Capacitor and Constant-Voltage Mode Disable Input Pin. The timer period is set by placing a capacitor, C_{TIMER} , to GND. The timer period is $t_{\text{TIMER}} = (C_{\text{TIMER}} \cdot 3 \text{ hours}) / (0.1\mu\text{F})$. When the TIMER pin is connected to V_{CC} , the timer is disabled, thus the constant-voltage mode is turned off and the IC will operate in constant-current mode only. Shorting the TIMER pin to GND will disable the internal timer function and the C/10 function.

GND (Pin 5): Ground.

PROG (Pin 6): Charge Current Program and Shutdown Input Pin. The charge current is programmed by connecting a resistor, R_{PROG} to ground. The charge current is $I_{\text{BAT}} = (V_{\text{PROG}} \cdot 800\Omega) / (R_{\text{PROG}} \cdot R_{\text{SENSE}})$. The IC can be forced into shutdown by floating the PROG pin and allowing the internal 2.5 μ A current source to pull the pin above the 2.457V shutdown threshold voltage.

DRV (Pin 7): Drive Output Pin for the P-Channel MOSFET or PNP Transistor. If a PNP transistor is used, it must have high gain (see Applications Information section).

V_{CC} (Pin 8): Input Supply Voltage. V_{CC} can range from 8.8V to 12V. If V_{CC} drops below $V_{\text{BAT}} + 54\text{mV}$, for example when the input supply is disconnected, then the IC enters sleep mode with $I_{\text{CC}} < 30\mu\text{A}$. Bypass this pin with a 1 μ F capacitor.

SENSE (Pin 9): Current Sense Input. A sense resistor, R_{SENSE} , must be connected from V_{CC} to the SENSE pin. This resistor is chosen using the following equation:

$$R_{\text{SENSE}} = (V_{\text{PROG}} \cdot 800\Omega) / (R_{\text{PROG}} \cdot I_{\text{BAT}})$$

ACPR (Pin 10): Wall Adapter Present Output. When the input voltage (wall adapter) is applied to the LTC1732-8.4, this pin is pulled to ground by an internal N-channel MOSFET which is capable of sinking 5mA to drive an external LED (See Applications Information Section).

OPERATION

The LTC1732-8.4 is a linear battery charger controller. The charge current is programmed by the combination of a program resistor (R_{PROG}) from the PROG pin to ground and a sense resistor (R_{SENSE}) between the V_{CC} and SENSE pins. R_{PROG} sets a program current through an internal trimmed 800Ω resistor setting up a voltage drop from V_{CC} to the input of the current amplifier (CA). The current amplifier servos the gate of the external P-channel MOSFET to force the same voltage drop across R_{SENSE} which sets the charge current. When the voltage at the BAT pin approaches the preset float voltage, the voltage amplifier (VA) will start sinking current which shrinks the voltage drop across R_{SENSE} , thus reducing the charge current.

A charge cycle begins when the potential at V_{CC} pin rises above the UVLO level and a program resistor is connected from the PROG pin to ground. At the beginning of the charge cycle, if the battery voltage is below 4.9V, the charger goes into trickle charge mode. The trickle charge current is 10% of the full-scale current. If the battery voltage stays low for one quarter of the total charge time, the charge sequence will terminate.

The charger goes into the fast charge constant-current mode after the voltage on the BAT pin rises above 4.9V. In constant-current mode, the charge current is set by the combination of R_{SENSE} and R_{PROG} .

When the battery approaches the final float voltage, the charge current will begin to decrease. When the current drops to 10% of the full-scale charge current, an internal comparator will turn off the pull-down N-channel MOSFET at the $\overline{\text{CHRG}}$ pin and connect a weak current source to ground to indicate an end-of-charge (C/10) condition.

An external capacitor on the TIMER pin sets the total charge time. After a time-out occurs, the charge cycle is terminated and the $\overline{\text{CHRG}}$ pin is forced to a high impedance state. To restart the charge cycle, remove the input voltage and reapply it, or float the PROG pin momentarily.

Replacing the battery while in the charge mode will cause the timer to be reset if the voltage of the new battery is below 8.05V. If the voltage is above 8.05V, the timer will continue for the remaining charge time. In the case when a time out has occurred, a new battery with a voltage of less than 8.05V can be inserted and charged automatically with the full programmed charge time.

For batteries like lithium-ion that require accurate final float voltage, the internal 2.457V reference, voltage amplifier and the resistor divider provide regulation with $\pm 1\%$ (max) accuracy. For NiMH and NiCd batteries, the LTC1732-8.4 can be used as a current source by pulling the TIMER pin to V_{CC} . When in the constant-current only mode, the voltage amplifier, timer, C/10 comparator and the trickle charge function are all disabled.

The charger can be shut down by floating the PROG pin ($I_{\text{CC}} \approx 1\text{mA}$). An internal current source will pull this pin high and clamp it at 3.5V.

When the input voltage is not present, the charger goes into a sleep mode, dropping I_{CC} to $10\mu\text{A}$. This greatly reduces the current drain on the battery and increases the standby time.

APPLICATIONS INFORMATION

Charger Conditions

The charger is off when any of the following conditions exist: the V_{CC} pin is less than 8.2V, the dropout voltage ($V_{CC} - V_{BAT}$) is less than 54mV, or the PROG pin is floating. The DRV pin will be pulled to V_{CC} and the internal resistor divider is disconnected to reduce the current drain on the battery.

Undervoltage Lockout (UVLO)

An internal undervoltage lockout circuit monitors the input voltage and keeps the charger in shutdown mode until V_{CC} rises above 8.2V. To prevent oscillation around $V_{CC} = 8.2V$, the UVLO circuit has built-in hysteresis.

Trickle Charge and Defective Battery Detection

At the beginning of the charging sequence, if the battery voltage is below 4.9V, the charger goes into trickle mode. The charge current drops to 10% of the full-scale current. If the low voltage persists for one quarter of the total charge time, the battery is considered defective, the charge cycle is terminated and the \overline{CHRG} pin output is forced to a high impedance state.

Shutdown

The LTC1732-8.4 can be forced into shutdown by floating the PROG pin and allowing the internal 2.5 μ A current source to pull the pin above the 2.457V shutdown threshold voltage. The DRV pin is pulled up to V_{CC} turning off the external P-channel MOSFET. The internal timer is reset in the shutdown mode.

Programming Charge Current

The formula for the battery charge current (see Block Diagram) is:

$$I_{BAT} = (I_{PROG})(800\Omega/R_{SENSE}) \\ = (2.457V/R_{PROG})(800\Omega/R_{SENSE}) \text{ or}$$

$$R_{PROG} = (2.457V/I_{BAT})(800\Omega/R_{SENSE})$$

where R_{PROG} is the total resistance from the PROG pin to ground.

For example, if 0.5A charge current is needed, select a value for R_{SENSE} that will drop 100mV at the maximum charge current. $R_{SENSE} = 0.1V/0.5A = 0.2\Omega$, then calculate:

$$R_{PROG} = (2.457V/500mA)(800\Omega/0.2\Omega) = 19.656k$$

For best stability over temperature and time, 1% resistors are recommended. The closest 1% resistor value is 19.6k.

Programming the Timer

The programmable timer terminates the charge cycle. Typically, when charging at a 1C rate, a discharged Li-Ion battery will become fully charged in 3 hours. For lower charge current rates, extend the timer accordingly. The length of the timer is programmed by an external capacitor at the TIMER pin. The total charge time is:

$$\text{Time (Hours)} = (3 \text{ Hours}) \cdot (C_{TIMER}/0.1\mu F) \text{ or}$$

$$C_{TIMER} = 0.1\mu F \cdot \text{Time (Hours)}/3 \text{ (Hours)}$$

The timer starts when an input voltage greater than 8.2V is applied and the program resistor is connected to ground. After a time-out occurs, the \overline{CHRG} output will go into a high impedance state to indicate that charging has stopped. Connecting the TIMER pin to V_{CC} disables the timer and also puts the charger into a constant-current mode. To only disable the timer function, short the TIMER pin to GND.

\overline{CHRG} Status Output Pin

When a charge cycle starts, the \overline{CHRG} pin is pulled to ground by an internal N-channel MOSFET that can drive an LED. When the battery current drops to 10% of the full-scale current ($C/10$), the N-channel MOSFET is turned off and a weak 35 μ A current source to ground is connected to the \overline{CHRG} pin. After a time-out occurs, the pin will go into a high impedance state. By using two different value pull-up resistors, a microprocessor can detect three states from this pin (charging, $C/10$ and stop charging). See Figure 1 and Table 1.

APPLICATIONS INFORMATION

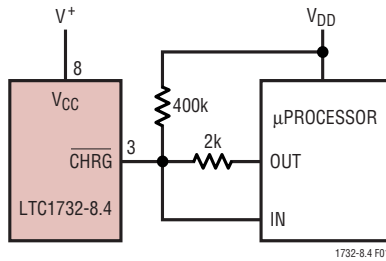

Figure 1. Microprocessor Interface

Table 1. Microprocessor Interface

IN	OUT	CHARGE STATUS
LOW	HIGH	Charge
LOW	Hi-Z	C/10
HIGH	Hi-Z	Stop Charging

When the LTC1732-8.4 is in charge mode, the $\overline{\text{CHRG}}$ pin is pulled low by an internal N-channel MOSFET. To detect this mode, force the digital output pin, OUT, high and measure the voltage at the $\overline{\text{CHRG}}$ pin. The N-channel MOSFET will pull the pin low even with a 2k pull-up resistor. Once the charge current drops to 10% of the full-scale current (C/10), the N-channel MOSFET is turned off and a 35 μA current source is connected to the $\overline{\text{CHRG}}$ pin. The IN pin is then pulled high by the 2k pull-up. By forcing the OUT pin into a high impedance state, the current source pulls the pin low through the 400k resistor. When the internal timer has expired, the $\overline{\text{CHRG}}$ pin changes to high impedance and the 400k resistor pulls the pin high to indicate that charging has stopped.

$\overline{\text{ACPR}}$ Output Pin

The LTC1732-8.4 has an $\overline{\text{ACPR}}$ output pin to indicate that the input supply (wall adapter) is higher than 8.2V and 55mV above the voltage at the BAT pin. When both conditions are met, the $\overline{\text{ACPR}}$ pin is pulled to ground by an N-channel MOSFET that is capable of driving an LED. Otherwise, this pin is high impedance.

$\overline{\text{CHRG}}$ Status Output Pin (C/10)

The LTC1732-8.4 includes a comparator to monitor the charge current to detect a near end-of-charge condition. This comparator does not terminate the charge cycle, but provides an output signal to indicate a near full charge condition. The timer is used to terminate the charge cycle. When the battery current falls below 10% of full scale, the comparator trips and turns off the N-channel MOSFET at the $\overline{\text{CHRG}}$ pin and switches in a 35 μA current source to ground. After an internal time delay of 15ms, this state is latched. This delay helps prevent false triggering due to transient currents. The end-of-charge comparator is disabled in trickle charge mode.

Gate Drive

Typically the LTC1732-8.4 controls an external P-channel MOSFET to supply current to the battery. An external PNP transistor can also be used as the pass transistor instead of the P-channel MOSFET. Due to the low current gain of the current amplifier (CA), a high gain Darlington PNP transistor is required to avoid excessive charge current error. The gain of the current amplifier is around 0.6 $\mu\text{A}/\text{mV}$. For every 1 μA of base current, a 1.6mV of gain error shows up at the inputs of CA. With $R_{\text{PROG}} = 19.6\text{k}$ (100mV across R_{SENSE}), it represents 1.67% of error in charging current.

APPLICATIONS INFORMATION

Constant-Current Only Mode

The LTC1732-8.4 can be used as a programmable current source by connecting the TIMER pin to V_{CC} . This is particularly useful for charging NiMH or NiCd batteries. In the constant-current only mode, the timer and voltage amplifier are both disabled. An external termination method is required to properly terminate the charge.

Battery Detection

The LTC1732-8.4 can detect the insertion of a new battery. When a battery with voltage of less than 8.05V is inserted, the LTC1732-8.4 resets the timer and a new charge cycle begins. If the voltage of the new battery is above 8.05V, the charging will not start if the TIMER has already timed out. If a new battery (with a voltage above 8.05V) is inserted while in the charging process, the timer will not be reset and charging will continue until the timer runs out.

After a time out has occurred and the battery remains connected, a new charge cycle will begin if the battery voltage drops below 8.05V due to self-discharge or external loading.

V_{CC} Bypass Capacitor

Many types of capacitors can be used for input bypassing. However, caution must be exercised when using multi-layer ceramic capacitors. Because of the self resonant and high Q characteristics of some types of ceramic capacitors, high voltage transients can be generated under some start-up conditions, such as connecting the charger input to a hot power source. To minimize these transients, only ceramic capacitors with X5R or X7R dielectric are recommended. Also, adding 1Ω or 2Ω in series with the ceramic capacitor will further reduce these start-up transients. For more information refer to Application Note 88.

Stability

The charger is stable without any compensation when a P-channel MOSFET is used as the pass transistor. However, a $10\mu\text{F}$ capacitor is recommended at the BAT pin to keep the ripple voltage low when the battery is disconnected.

If a PNP transistor is used for the pass transistor, a 1000pF capacitor is required from the DRV pin to V_{CC} . This capacitor is needed to help stabilize the voltage loop. A $10\mu\text{F}$ capacitor at the BAT pin is also recommended when a battery is not present.

PACKAGE DESCRIPTION

MS Package 10-Lead Plastic MSOP (Reference LTC DWG # 05-08-1661)

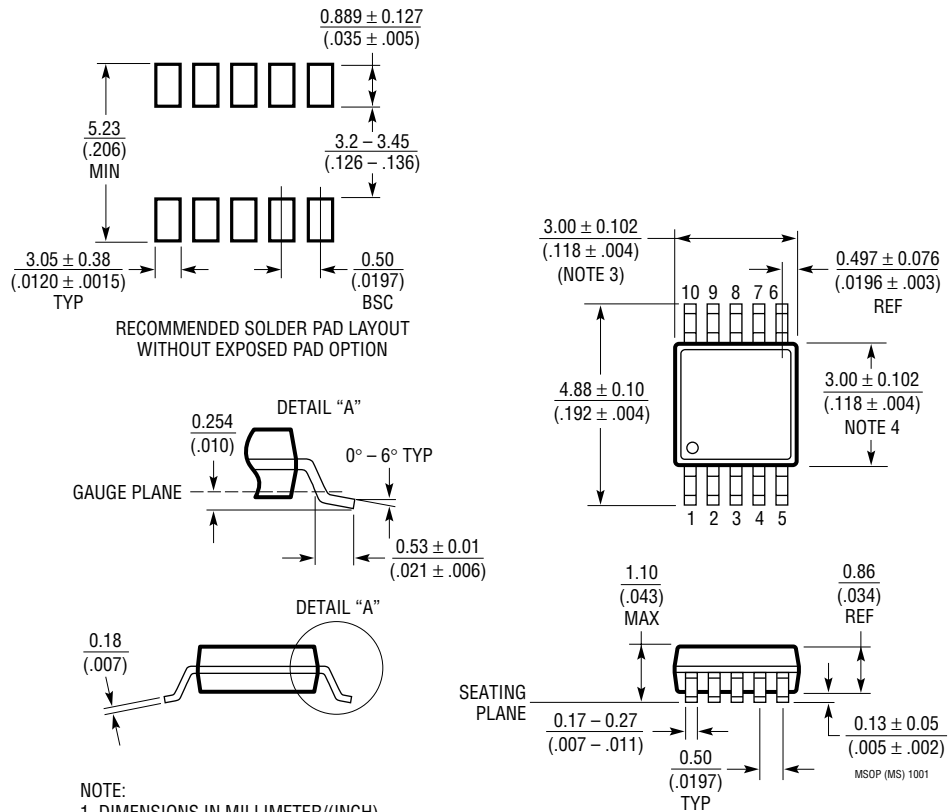

TYPICAL APPLICATION

2-Cell 8.4V Linear Charger Using a PNP Pass Transistor

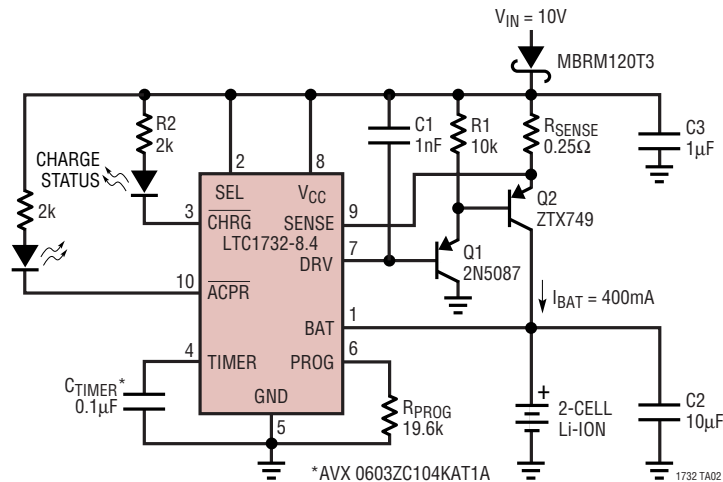

RELATED PARTS

PART NUMBER	DESCRIPTION	COMMENTS
LT [®] 1510-5	500kHz Constant-Voltage/Constant-Current Battery Charger	Most Compact, Up to 1.5A, Charges NiCd, NiMH, Li-Ion Cells
LT1512	SEPIC Battery Charger	V _{IN} Can Be Higher or Lower Than Battery Voltage, 1.5A Switch
LTC1571-1/ LTC1571-2/ LTC1571-5	200kHz/500kHz 1.5A Constant-Current/Constant-Voltage Battery Charger	Charges 1- or 2-Cell Li-Ion Batteries, Preset and Adjustable Battery Voltages, C/10 Charge Detection
LT1620	Rail-to-Rail Current Sense Amplifier	Precise Output Current Programming, Up to 32V _{OUT} , Up to 10A I _{OUT}
LTC1729	Termination Controller for Li-Ion	Time or Charge Current Termination, Automatic Charger/Battery Detection, Status Output, Preconditioning, 8-Lead MSOP
LTC1730/ LTC4052	Complete Li-Ion Pulse Battery Charger with Internal FET and Thermal Regulation	Efficient 1.5A Charger with Many Features Including Overcurrent Battery Protection
LTC1731	Complete Li-Ion Linear Battery Charger Controller	Single Cell and 2-Cell Li-Ion, C/10 Detection, Complete Charger
LTC1732-4/ LTC1732-4.2	Complete Linear Battery Charger Controller for Single Cell Li-Ion Battery	No Firmware Required, AC Adapter Indicator Automatic Charge and Recharge
LTC1733	Complete Li-Ion Linear Battery Charger with Internal FET	1.5A Charger with Many Features Including Thermal Feedback for Increased Charge Current without Exceeding Maximum Temperature
LTC1734/ LTC1734L	ThinSOT Li-Ion Linear Charger	Only Two External Components, V _{PROG} Tracks I _{CHARGE} No Diode Needed, No Sense Resistor Needed, 50mA to 700mA Charge Current
LTC4050	Complete Li-Ion Linear Charger with Thermistor Interface	No Firmware Required, AC Adapter Indicator Automatic Charge and Recharge
LTC4053	USB Compatible Li-Ion Linear Battery Charger	Operate from Wall Adapter Input and/or USB Input, 100mA/500mA up to 1.25A Charge Current, Thermal Limit Prevent Over Heating, Standalone Charger.
LTC4412	Low Loss PowerPath™ Controller in ThinSOT™	Automatic Switching Between DC Sources, Load Sharing, Replaces ORing Diodes

ThinSot and PowerPath are trademarks of Linear Technology Corporation.

17328F