

FSDL0365RNB, FSDM0365RNB

Green Mode Fairchild Power Switch (FPS™)

Features

- Internal Avalanche Rugged Sense FET
- Consumes only 0.65W at 240VAC & 0.3W load with Advanced Burst-Mode Operation
- Frequency Modulation for low EMI
- Precision Fixed Operating Frequency
- Internal Start-up Circuit
- Pulse by Pulse Current Limiting
- Over Voltage Protection
- Over Load Protection
- Internal Thermal Shutdown Function
- Auto-Restart Mode
- Under Voltage Lockout
- Low Operating Current (3mA)
- Adjustable Peak Current Limit
- Built-in Soft Start

Applications

- SMPS for VCR, SVR, STB, DVD & DVCD
- SMPS for Printer, Facsimile & Scanner
- Adaptor for Camcorder

Description

The FSDx0365RNB(x stands for L, M) are integrated Pulse Width Modulators (PWM) and Sense FETs specifically designed for high performance offline Switch Mode Power Supplies (SMPS) with minimal external components. Both devices are integrated high voltage power switching regulators which combine an avalanche rugged Sense FET with a current mode PWM control block. The integrated PWM controller features include: a fixed oscillator with frequency modulation for reduced EMI, Under Voltage Lock Out (UVLO) protection, Leading Edge Blanking (LEB), optimized gate turn-on/turn-off driver, Thermal Shut Down (TSD) protection and temperature compensated precision current sources for loop compensation and fault protection circuitry. The FSDx0365RNB offer better performance in Soft Start than FSDx0365RN. When compared to a discrete MOSFET and controller or RCC switching converter solution, the FSDx0365RNB reduce total component count, design size, weight and at the same time increase efficiency, productivity, and system reliability. Both devices are a basic platform well suited for cost effective designs of flyback converters.

OUTPUT POWER TABLE				
PRODUCT	230VAC $\pm 15\%$ ⁽³⁾		85-265VAC	
	Adapt-er ⁽¹⁾	Open Frame ⁽²⁾	Adapt-er ⁽¹⁾	Open Frame ⁽²⁾
FSDM0265RNB	16W	27W	13W	20W
FSDL0365RNB	19W	30W	16W	24W
FSDM0365RNB	19W	30W	16W	24W

Table 1. Notes: 1. Typical continuous power in a non-ventilated enclosed adapter with sufficient drain pattern or something as a heat sinker measured at 50°C ambient. 2. Maximum practical continuous power in an open frame design with sufficient drain pattern or something as a heat sinker at 50°C ambient. 3. 230 VAC or 100/115 VAC with doubler.

Typical Circuit

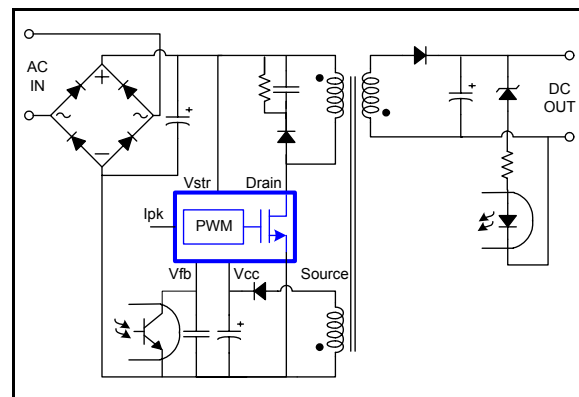

Figure 1. Typical Flyback Application

Internal Block Diagram

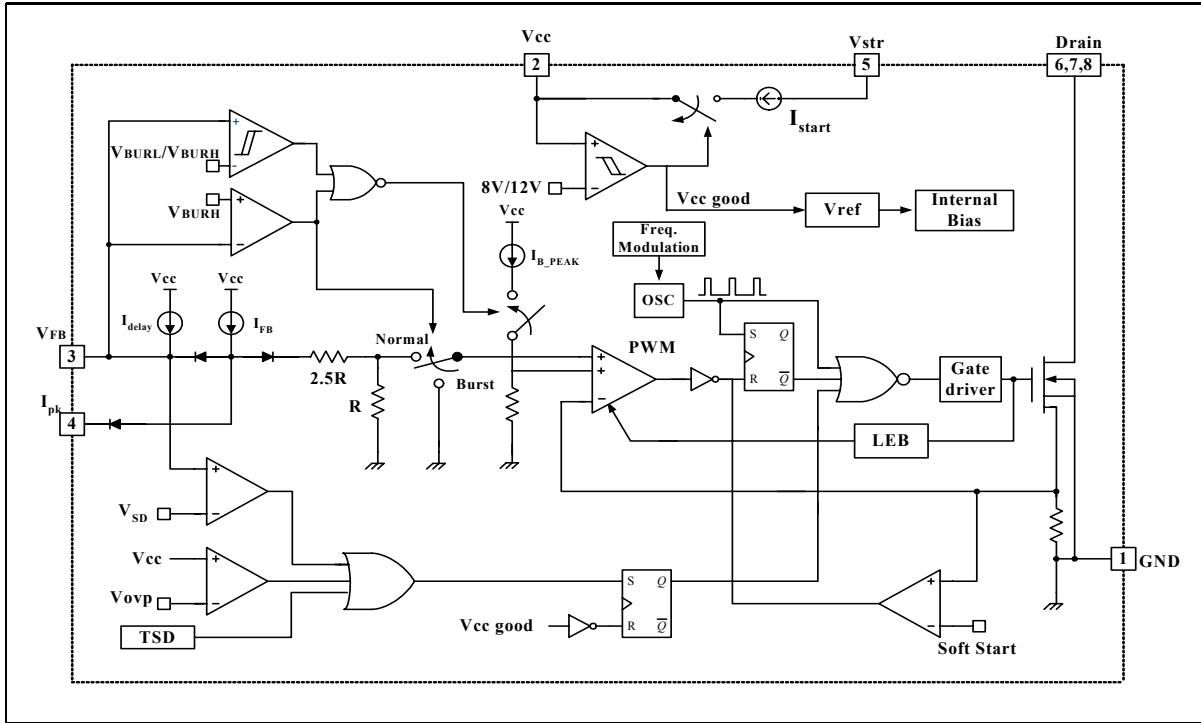

Figure 2. Functional Block Diagram of FSDx0365RNB

Pin Definitions

Pin Number	Pin Name	Pin Function Description
1	GND	Sense FET source terminal on primary side and internal control ground.
2	Vcc	Positive supply voltage input. Although connected to an auxiliary transformer winding, current is supplied from pin 5 (Vstr) via an internal switch during startup (see Internal Block Diagram section). It is not until Vcc reaches the UVLO upper threshold (12V) that the internal start-up switch opens and device power is supplied via the auxiliary transformer winding.
3	Vfb	The feedback voltage pin is the non-inverting input to the PWM comparator. It has a 0.9mA current source connected internally while a capacitor and optocoupler are typically connected externally. A feedback voltage of 6V triggers over load protection (OLP). There is a time delay while charging between 3V and 6V using an internal 5uA current source, which prevents false triggering under transient conditions but still allows the protection mechanism to operate under true overload conditions.
4	l _{pk}	Pin to adjust the current limit of the Sense FET. The feedback 0.9mA current source is diverted to the parallel combination of an internal 2.8kΩ resistor and any external resistor to GND on this pin to determine the current limit. If this pin is tied to Vcc or left floating, the typical current limit will be 2.15A.
5	Vstr	This pin connects directly to the rectified AC line voltage source. At start up the internal switch supplies internal bias and charges an external storage capacitor placed between the Vcc pin and ground. Once the Vcc reaches 12V, the internal switch is disabled.
6, 7, 8	Drain	The Drain pin is designed to connect directly to the primary lead of the transformer and is capable of switching a maximum of 650V. Minimizing the length of the trace connecting this pin to the transformer will decrease leakage inductance.

Pin Configuration

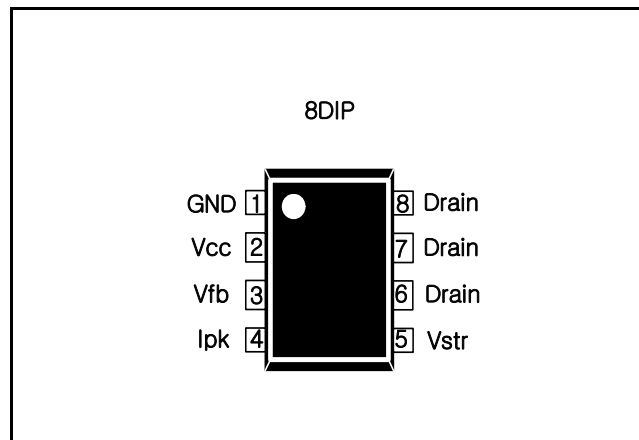

Figure 3. Pin Configuration (Top View)

Absolute Maximum Ratings

(Ta=25°C, unless otherwise specified)

Characteristic	Symbol	Value	Unit
Maximum Drain Pin Voltage	V _{DRAIN,MAX}	650	V
Maximum V _{str} Pin Voltage	V _{STR,MAX}	650	V
Drain Current Pulsed ⁽¹⁾	I _{DM}	12.0	ADC
Single Pulsed Avalanche Energy ⁽²⁾	E _{AS}	127	mJ
Maximum Supply Voltage	V _{CC,MAX}	20	V
Analog Input Voltage Range	V _{FB}	-0.3 to V _{CC}	V
Total Power Dissipation	P _D	1.56	W
Operating Junction Temperature.	T _J	Internally limited	°C
Operating Ambient Temperature.	T _A	-25 to +85	°C
Storage Temperature Range.	T _{STG}	-55 to +150	°C

Note:

1. Repetitive rating: Pulse width limited by maximum junction temperature
2. L = 51mH, starting T_j = 25°C
3. L = 13μH, starting T_j = 25°C
4. V_{sd} is shutdown feedback voltage (see Protection Section in Electrical Characteristics)

Thermal Impedance

Parameter	Symbol	Value	Unit
8DIP			
Junction-to-Ambient Thermal	θ _{JA} ⁽¹⁾	80.01 ⁽³⁾	°C/W
Junction-to-Case Thermal	θ _{JC} ⁽²⁾	18.85	°C/W
Junction-to-Top Thermal	ψ _{JT} ⁽⁴⁾	33.70	°C/W

Note:

1. Free standing with no heatsink.
2. Measured on the DRAIN pin close to plastic interface.
3. Without copper clad.
4. Measured on the PKG top surface.

* - all items are tested with the standard JESD 51-10(DIP)

Electrical Characteristics

(Ta = 25°C unless otherwise specified)

Parameter	Symbol	Condition	Min.	Typ.	Max.	Unit
Sense FET SECTION						
Off-State Current (Max.Rating =660V)	IDSS	VDS=660V, VGS=0V	-	-	50	μA
		VDS=0.8Max.Rating, VGS=0V, TC=125°C	-	-	200	μA
On-State Resistance ⁽¹⁾	RDS(ON)	VGS=10V, ID=0.5A	-	3.6	4.5	Ω
Input Capacitance	CISS	VGS=0V, VDS=25V, F=1MHz	-	315	-	pF
Output Capacitance	COSS		-	47	-	pF
Reverse Transfer Capacitance	CRSS		-	9	-	pF
Turn On Delay Time	TD(ON)	VDS=325V, ID=1.0A (Sense FET switching time is essentially independent of operating temperature)	-	11.2	-	ns
Rise Time	TR		-	34	-	ns
Turn Off Delay Time	TD(OFF)		-	28.2	-	ns
Fall Time	TF		-	32	-	ns
CONTROL SECTION						
Output Frequency	FOSC	FSDM0365RNB	61	67	73	KHz
Output Frequency Modulation	FMOD		±1.5	±2.0	±2.5	KHz
Output Frequency	FOSC	FSDL0365RNB	45	50	55	KHz
Output Frequency Modulation	FMOD		±1.0	±1.5	±2.0	KHz
Frequency Change With Temperature ⁽²⁾	-	-25°C ≤ Ta ≤ 85°C	-	±5	±10	%
Maximum Duty Cycle	DMAX		71	77	83	%
Minimum Duty Cycle	DMIN		0	0	0	%
Start threshold voltage	VSTART	VFB=GND	11	12	13	V
Stop threshold voltage	VSTOP	VFB=GND	7	8	9	V
Feedback Source Current	IFB	VFB=GND	0.7	0.9	1.1	mA
Internal Soft Start Time	TS/S	VFB=4V	10	15	20	ms
BURST MODE SECTION						
Burst Mode Voltages	VBURH	-	0.4	0.5	0.6	V
	VBURL	-	0.25	0.35	0.45	V
PROTECTION SECTION						
Drain to Source Peak Current Limit	I _{OVER}	Max. inductor current	1.89	2.15	2.41	A
Current Limit Delay ⁽³⁾	TCLD		-	500	-	ns
Thermal Shutdown	TSD	-	125	140	-	°C

Shutdown Feedback Voltage	VSD		5.5	6.0	6.5	V
Over Voltage Protection	VOVP		18	19	-	V
Shutdown Feedback Delay Current	IDELAY	VFB=4V	3.5	5.0	6.5	μA
Leading Edge Blanking Time	TLEB		200	-	-	ns
TOTAL DEVICE SECTION						
Operating Current	IOP	VCC=14V	1	3	5	mA
Start Up Current	ISTART	VCC=0V	0.7	0.85	1.0	mA
Vstr Supply Voltage	VSTR	VCC=0V	35	-	-	V

Note:

1. Pulse test: Pulse width $\leq 300\mu\text{s}$, duty $\leq 2\%$
2. These parameters, although guaranteed, are tested in EDS (wafer test) process
3. These parameters, although guaranteed, are not 100% tested in production

Comparison Between KA5x0365RN and FSDx0365RNB

Function	KA5x0365RN	FSDx0365RNB	FSDx0365RNB Advantages
Soft-Start	not applicable	15mS	<ul style="list-style-type: none"> • Gradually increasing current limit during soft-start further reduces peak current and voltage component stresses • Eliminates external components used for soft-start in most applications • Reduces or eliminates output overshoot
External Current Limit	not applicable	Programmable of default current limit	<ul style="list-style-type: none"> • Smaller transformer • Allows power limiting (constant over-load power) • Allows use of larger device for lower losses and higher efficiency.
Frequency Modulation	not applicable	±2.0KHz @67KHz ±1.5KHz @50KHz	<ul style="list-style-type: none"> • Reduced conducted EMI
Burst Mode Operation	not applicable	Yes-built into controller	<ul style="list-style-type: none"> • Improve light load efficiency • Reduces no-load consumption • Transformer audible noise reduction
Drain Creepage at Package	1,02mm	7.62mm	<ul style="list-style-type: none"> • Greater immunity to arcing as a result of build-up of dust, debris and other contaminants

Typical Performance Characteristics (Sense FET part)

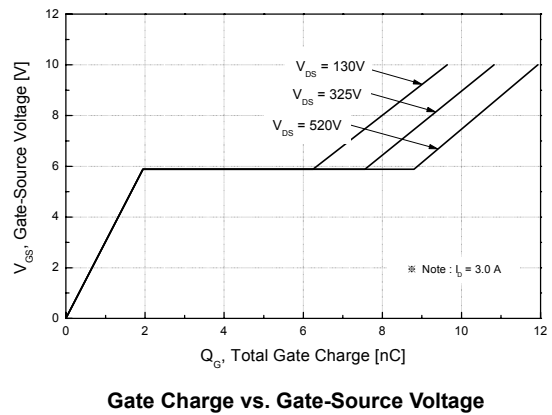
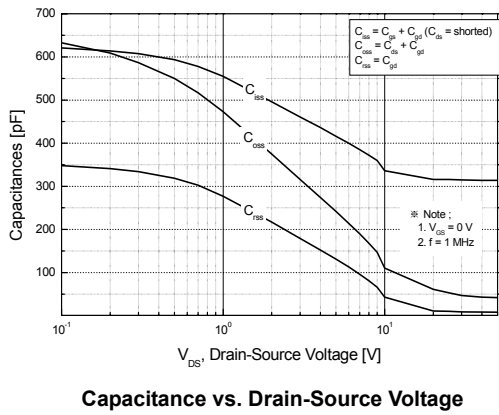
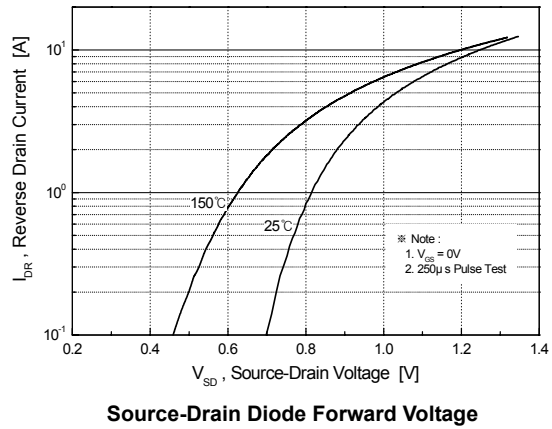
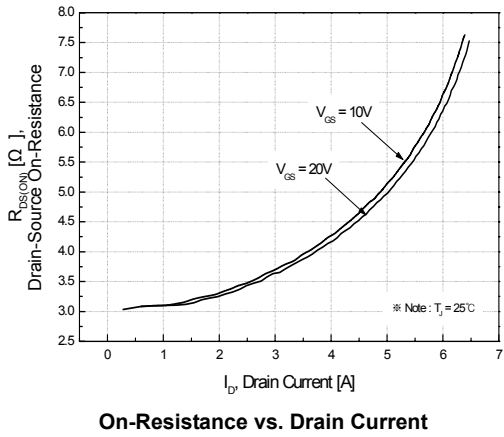
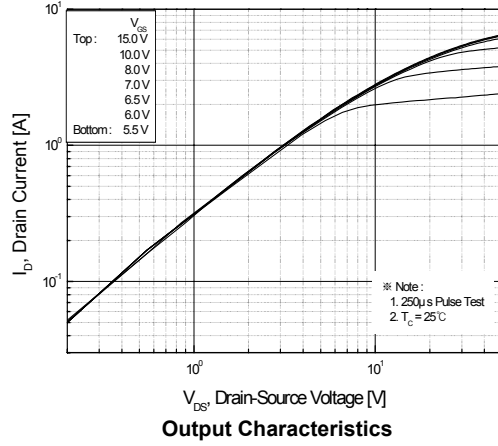

Typical Performance Characteristics (Continued)

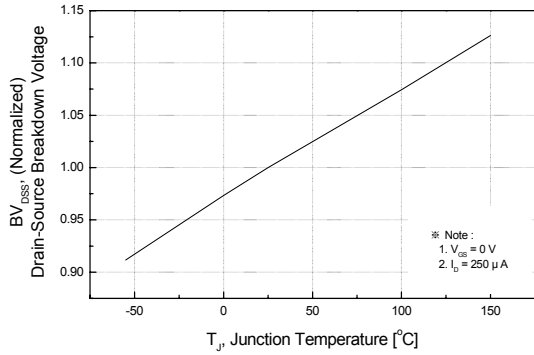

Breakdown Voltage vs. Temperature

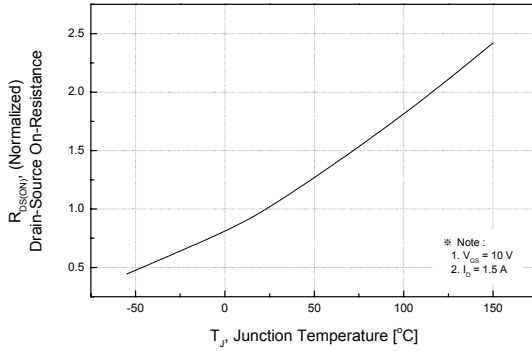

On-Resistance vs. Temperature

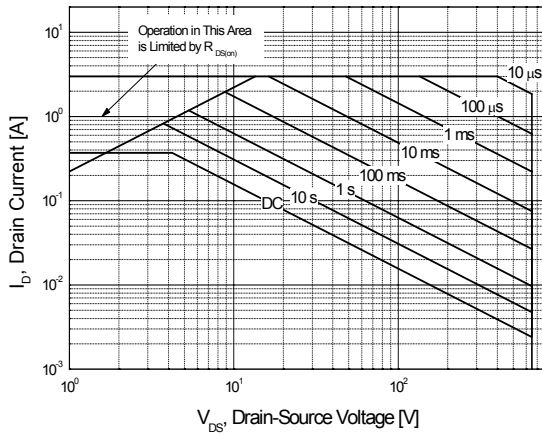

Max. Safe Operating Area

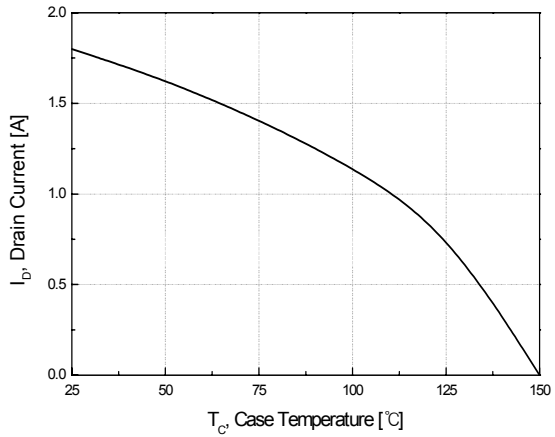

Max. Drain Current vs. Case Temperature

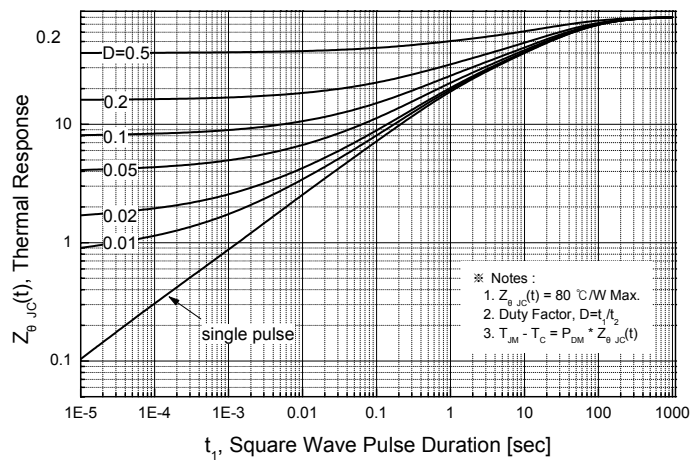

Thermal Response

Typical Performance Characteristics (Control Part)

(These characteristic graphs are normalized at Ta = 25°C)

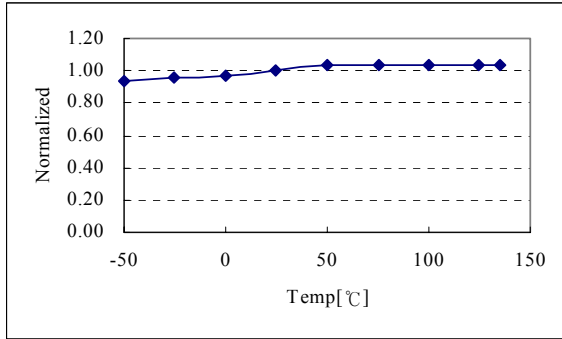

Operating Frequency (Fosc)

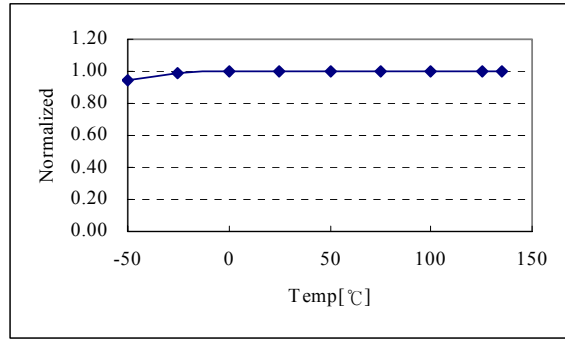

Frequency Modulation (FMOD)

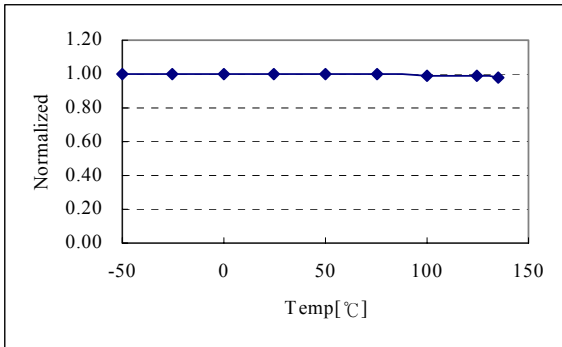

Maximum duty cycle (Dmax)

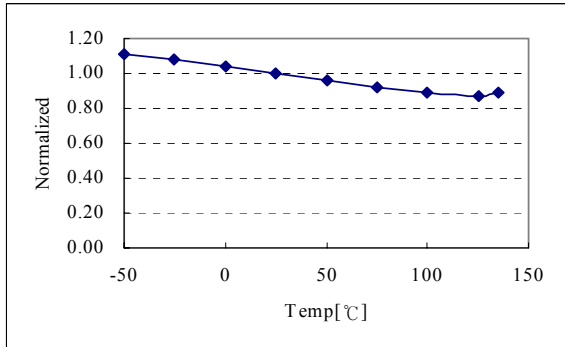

Operating supply current (Iop)

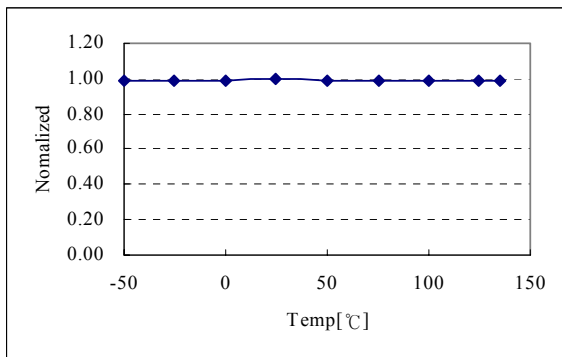

Start Threshold Voltage (Vstart)

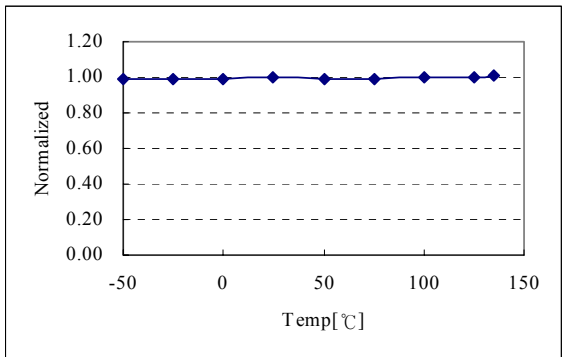

Stop Threshold Voltage (Vstop)

Typical Performance Characteristics (Continued)

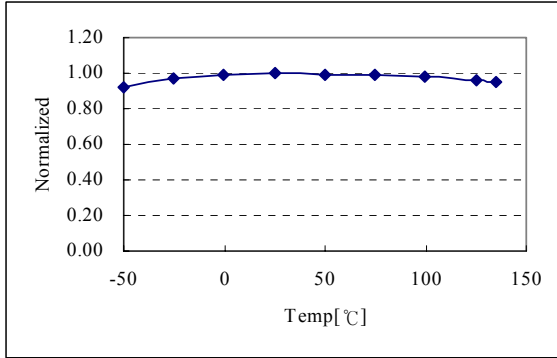

Feedback Source Current (Ifb)

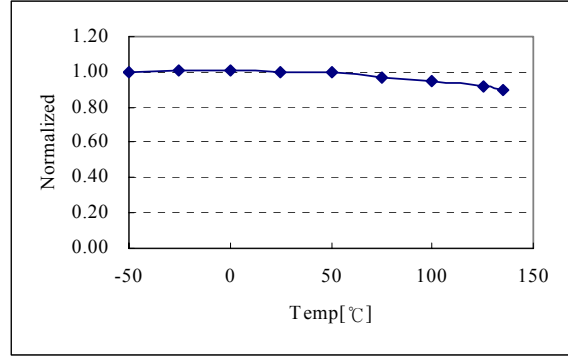

Peak current limit (Iover)

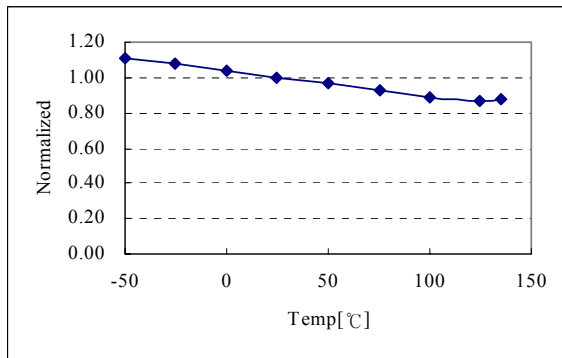

Start up Current (Istart)

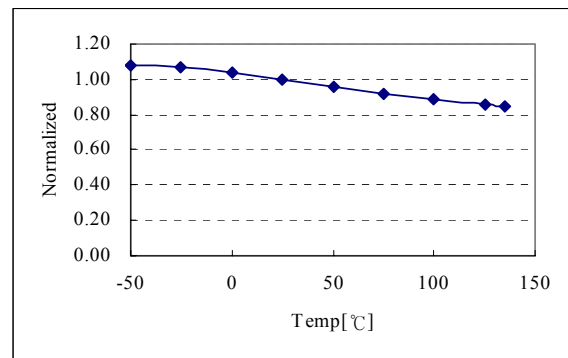

J-FET Start up current (Istr)

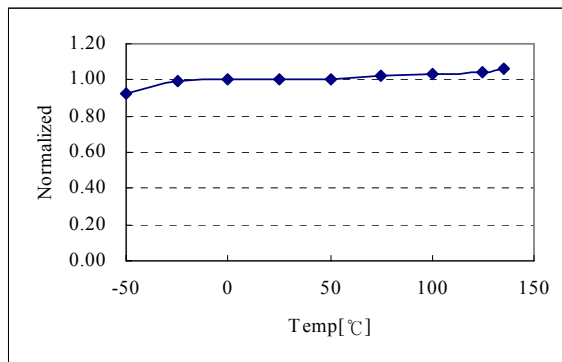

Burst peak current (Iburst)

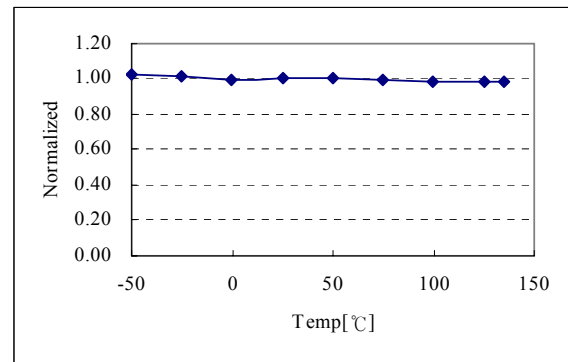

Over Voltage Protection (Vovp)

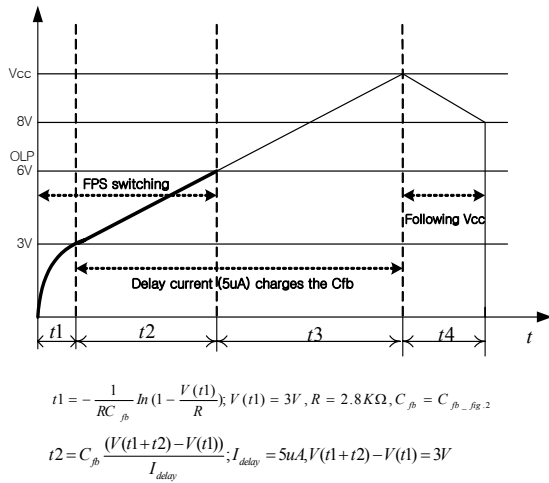

Figure 6. Over load protection

4.2 Thermal Shutdown (TSD) : The Sense FET and the control IC are integrated, making it easier for the control IC to detect the temperature of the Sense FET. When the temperature exceeds approximately 140°C, thermal shutdown is activated.

4.3 Over Voltage Protection (OVP) : In case of malfunction in the secondary side feedback circuit, or feedback loop open caused by a defect of solder, the current through the opto-coupler transistor becomes almost zero. Then, Vfb climbs up in a similar manner to the over load situation, forcing the preset maximum current to be supplied to the SMPS until the over load protection is activated. Because excess energy is provided to the output, the output voltage may exceed the rated voltage before the over load protection is activated, resulting in the breakdown of the devices in the secondary side. In order to prevent this situation, an over voltage protection (OVP) circuit is employed. In general, Vcc is proportional to the output voltage and the FPS uses Vcc instead of directly monitoring the output voltage. If VCC exceeds 19V, OVP circuit is activated resulting in termination of the switching operation. In order to avoid undesired activation of OVP during normal operation, Vcc should be properly designed to be below 19V.

5. Soft Start : The FPS has an internal soft start circuit that increases the feedback voltage together with the Sense FET current slowly after it starts up. The typical soft start time is 15msec, as shown in figure 7, where progressive increments of Sense FET current are allowed during the start-up phase. The pulse width to the power switching device is progressively increased to establish the correct working conditions for transformers, inductors, and capacitors. The voltage on the output capacitors is progressively increased with the intention of smoothly establishing the required output volt-

age. It also helps to prevent transformer saturation and reduce the stress on the secondary diode.

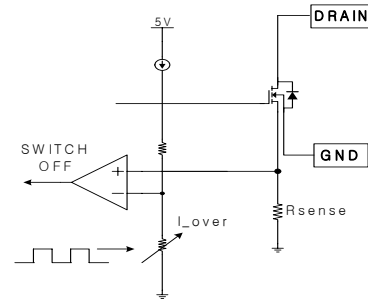
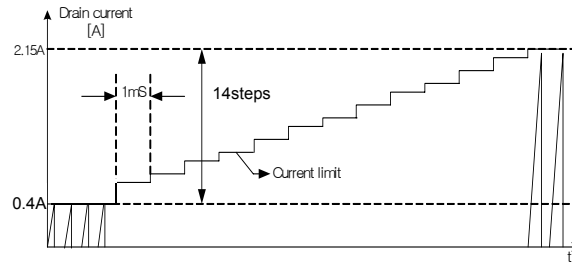

Figure 7. Soft Start Function

6. Burst operation : In order to minimize power dissipation in standby mode, the FPS enters burst mode operation.

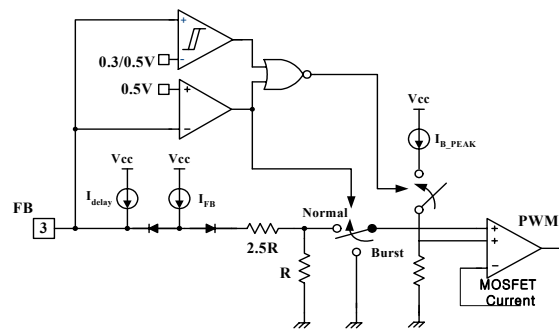

Figure 8. Circuit for Burst operation

As the load decreases, the feedback voltage decreases. As shown in figure 9, the device automatically enters burst mode when the feedback voltage drops below V_{BURH}(500mV). Switching still continues but the current limit is set to a fixed limit internally to minimize flux density in the transformer. The fixed current limit is larger than that defined by V_{fb} = V_{BURH} and therefore, V_{fb} is driven down further. Switching continues until the feedback voltage drops below V_{BURL}(350mV). At this point switching stops and

the output voltages start to drop at a rate dependent on the standby current load. This causes the feedback voltage to rise. Once it passes $V_{BURH}(500mV)$ switching resumes. The feedback voltage then falls and the process repeats. Burst mode operation alternately enables and disables switching of the power Sense FET thereby reducing switching loss in Standby mode.

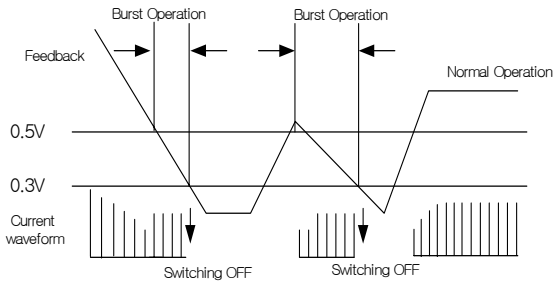

Figure 9. Circuit for Burst Operation

7. Frequency Modulation : EMI reduction can be accomplished by modulating the switching frequency of a switched power supply. Frequency modulation can reduce EMI by spreading the energy over a wider frequency range than the band width measured by the EMI test equipment. The amount of EMI reduction is directly related to the depth of the reference frequency. As can be seen in Figure 10, the frequency changes from 65KHz to 69KHz in 4mS for the FSDM0365RNB. Frequency modulation allows the use of a cost effective inductor instead of an AC input mode choke to satisfy the requirements of world wide EMI limits.

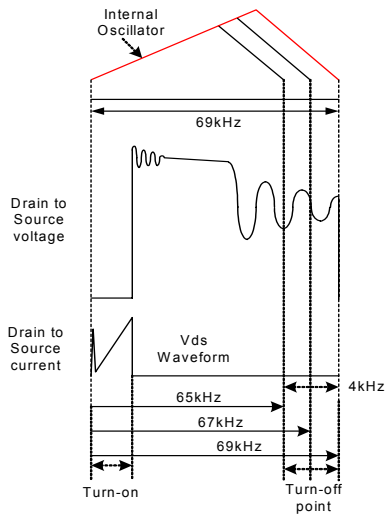

Figure 10. Frequency Modulation Waveform

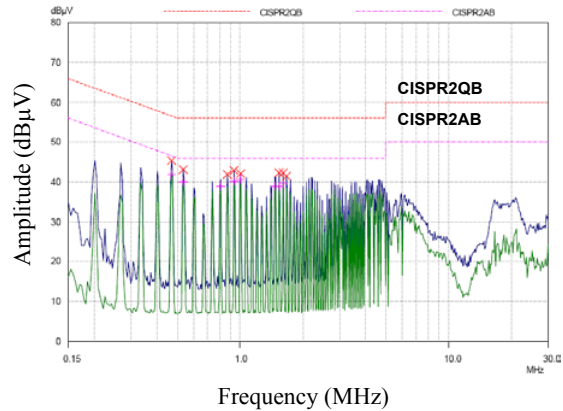

Figure 11. KA5-series FPS Full Range EMI scan(67KHz, no Frequency Modulation) with DVD Player SET

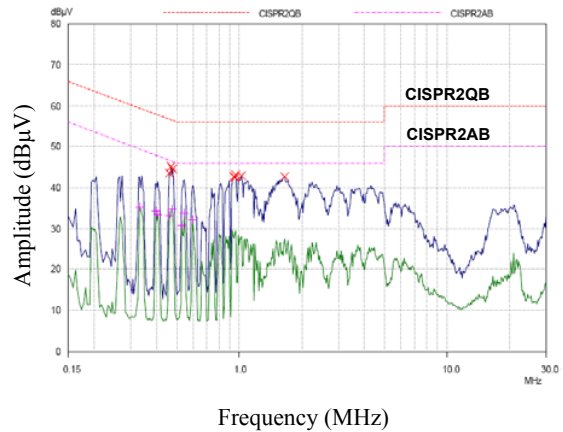

Figure 12. FSDX-series FPS Full Range EMI Scan (67KHz, with Frequency Modulation) with DVD Player SET

Typical application circuit

1. Set Top Box Example Circuit (20W Output Power)

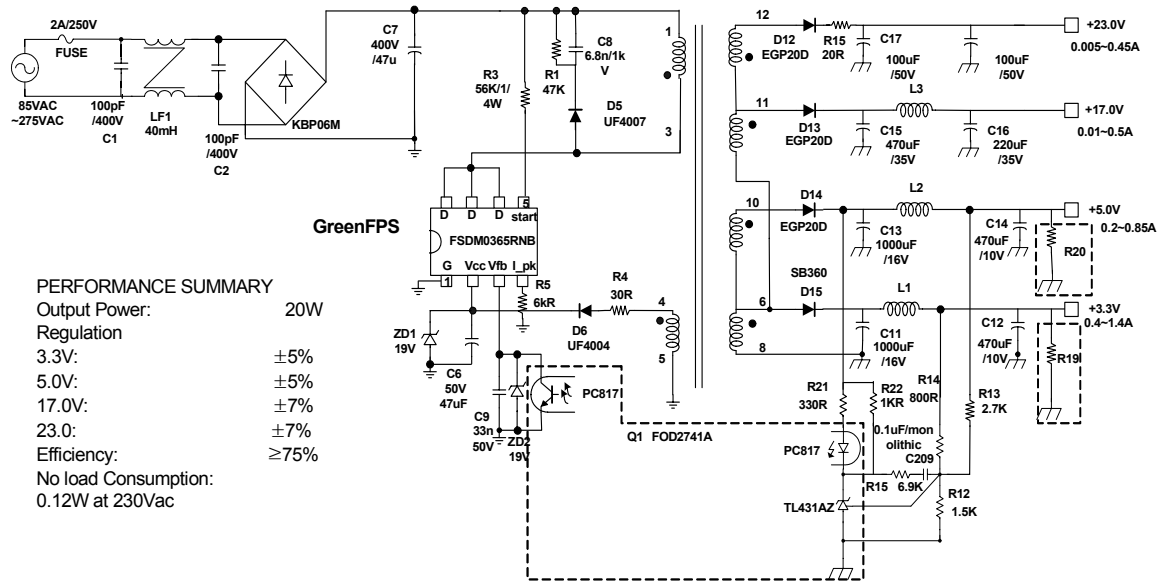

Figure15. 20W multiple power supply using FSDM0365RNB

Multiple Output, 20W, 85-265VAC Input Power supply:

Figure 15 shows a multiple output supply typical for high end set-top boxes containing high capacity hard disks for recording or LIPS(LCD Inverter Power Supply) for 15" LCD monitor. The supply delivers an output power of 20W cont./24 W peak (thermally limited) from an input voltage of 85 to 265 VAC. Efficiency at 20W, 85VAC is ≥75%.

The 3.3 V and 5 V outputs are regulated to ±5% without the need for secondary linear regulators. DC stacking (the secondary winding reference for the other output voltages is connected to the anode of D15. For more accuracy, connection to the cathode of D15 will be better.) is used to minimize the voltage error for the higher voltage outputs. Due to the high ambient operating temperature requirement typical of a set-top box (60 °C) the FSDM0365RNB is used to reduce conduction losses without a heatsink. Resistor R5 sets the device current limit to limit overload power.

Leakage inductance clamping is provided by R1 and C8, keeping the DRAIN voltage below 650 V under all conditions. Resistor R1 and capacitor C8 are selected such that R1 dissipates power to prevent rising of DRAIN Voltage caused by leakage inductance. The frequency modulation feature of FSDM0365RNB allows the circuit shown to meet CISPR2AB with simple EMI filtering (C1, LF1 and C2) and the output grounded. The secondaries are rectified and smoothed by D12, D13, D14, and D15. Diode D15 for the 3.4V output is a Schottky diode to maximize efficiency. Diode D14 for the 5 V output is a PN type to center the 5 V output at 5 V. The 3.3 V and 5 V output voltage require two capacitors in parallel to meet the ripple current requirement.

Switching noise filtering is provided by L3, L2 and L1.

Resistor R15 prevents peak charging of the lightly loaded 23V output. The outputs are regulated by the reference (TL431) voltage in secondary. Both the 3.3 V and 5 V outputs are sensed via R13 and R14. Resistor R22 provides bias for TL431 and R21 sets the overall DC gain. Resistor R21, C209, R14 and R13 provide loop compensation.

2. Transformer Specification

1. TRANSFORMER SPECIFICATION

- SCHEMATIC DIAGRAM (TRANSFORMER)

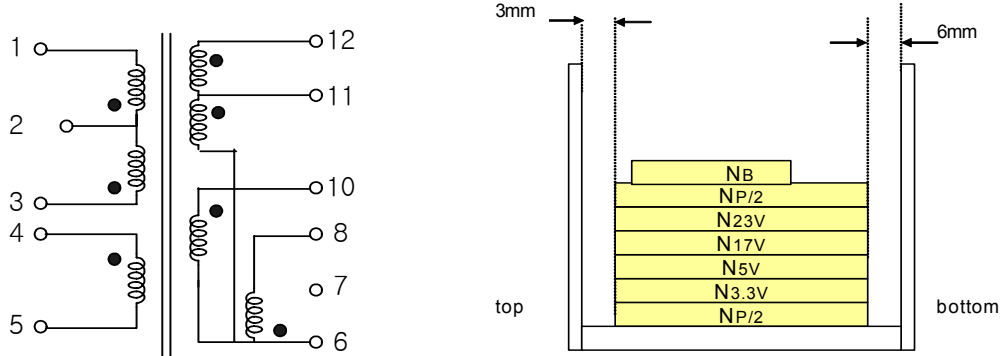

2. WINDING SPECIFICATION

NO.	PIN(S → F)	WIRE	TURNS	WINDING METHOD
NP/2	3 → 2	0.25 Φ × 1	22	SOLENOID WINDING
N3.3V	6 → 8	0.3 Φ × 8	2	STACK WINDING
N5V	10 → 6	0.3 Φ × 2	1	STACK WINDING
N16V	11 → 6	0.3 Φ × 4	7	SOLENOID WINDING
N23V	12 → 11	0.3 Φ × 2	3	SOLENOID WINDING
NP/2	2 → 1	0.25 Φ × 1	22	SOLENOID WINDING
NB	4 → 5	0.25 Φ × 1	10	CENTER WINDING

3. ELECTRIC CHARACTERISTIC

CLOSURE	PIN	SPEC.	REMARKS
INDUCTANCE	1 - 3	800uH ± 10%	1KHz, 1V
LEAKAGE L	1 - 3	15uH MAX.	2nd ALL SHORT

4. BOBBIN & CORE.

CORE: EER2828
BOBBIN: EER2828

Layout Considerations

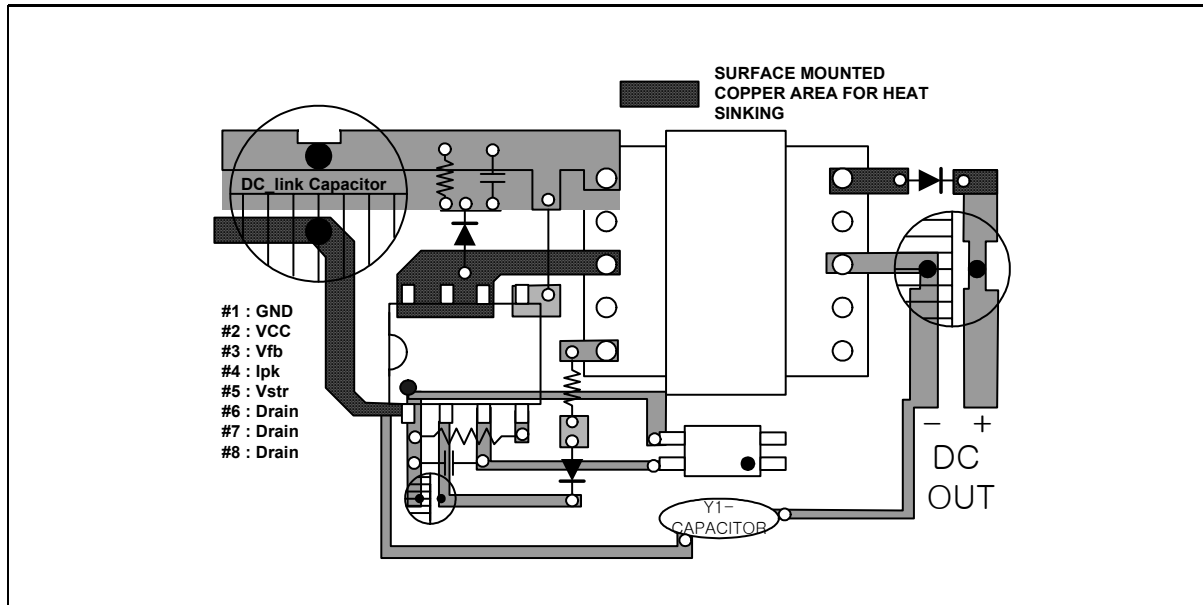
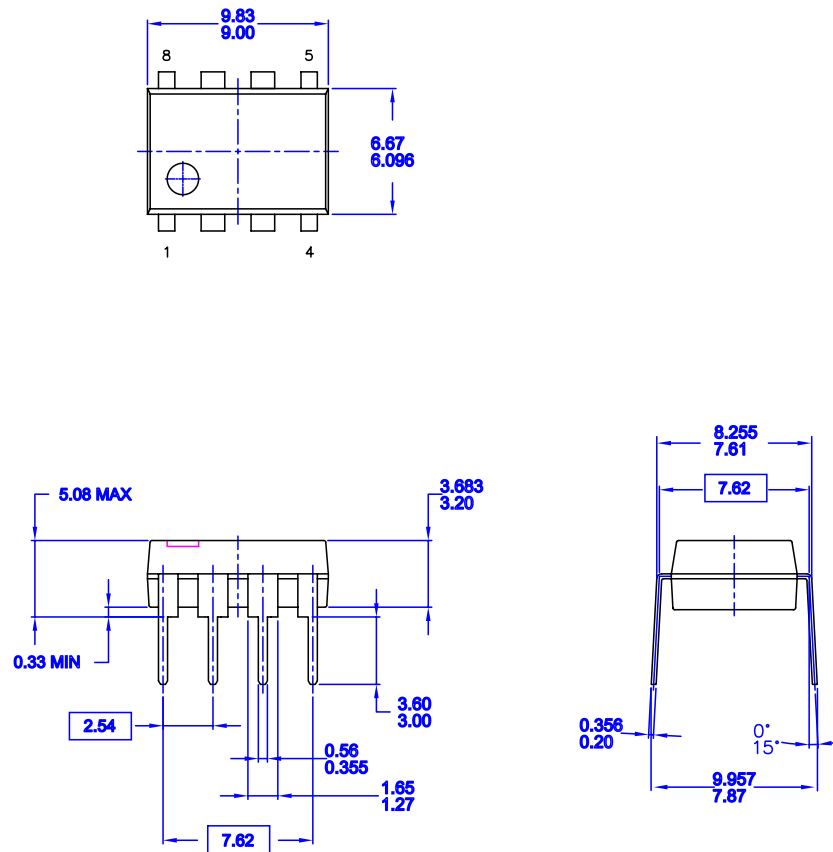

Figure 14. Layout Considerations for FSDx0365RNB using 8DIP

Package Dimensions

8DIP



- NOTES: UNLESS OTHERWISE SPECIFIED**
- A) THIS PACKAGE CONFORMS TO JEDEC MS-001 VARIATION BA
 - B) ALL DIMENSIONS ARE IN MILLIMETERS.
 - C) DIMENSIONS ARE EXCLUSIVE OF BURRS, MOLD FLASH, AND TIE BAR EXTRUSIONS.
 - D) DIMENSIONS AND TOLERANCES PER ASME Y14.5M-1994

MKT-N08FrevB

Ordering Information

Product Number	Package	Marking Code	BV _{DSS}	FOSC	R _{DS(on)}
FSDM0365RNB	8DIP	DM0365R	650V	67KHz	3.6Ω
FSDL0365RNB	8DIP	DL0365R	650V	50KHz	3.6Ω

DISCLAIMER

FAIRCHILD SEMICONDUCTOR RESERVES THE RIGHT TO MAKE CHANGES WITHOUT FURTHER NOTICE TO ANY PRODUCTS HEREIN TO IMPROVE RELIABILITY, FUNCTION OR DESIGN. FAIRCHILD DOES NOT ASSUME ANY LIABILITY ARISING OUT OF THE APPLICATION OR USE OF ANY PRODUCT OR CIRCUIT DESCRIBED HEREIN; NEITHER DOES IT CONVEY ANY LICENSE UNDER ITS PATENT RIGHTS, NOR THE RIGHTS OF OTHERS.

LIFE SUPPORT POLICY

FAIRCHILD'S PRODUCTS ARE NOT AUTHORIZED FOR USE AS CRITICAL COMPONENTS IN LIFE SUPPORT DEVICES OR SYSTEMS WITHOUT THE EXPRESS WRITTEN APPROVAL OF THE PRESIDENT OF FAIRCHILD SEMICONDUCTOR CORPORATION. As used herein:

1. Life support devices or systems are devices or systems which, (a) are intended for surgical implant into the body, or (b) support or sustain life, and (c) whose failure to perform when properly used in accordance with instructions for use provided in the labeling, can be reasonably expected to result in a significant injury of the user.
2. A critical component in any component of a life support device or system whose failure to perform can be reasonably expected to cause the failure of the life support device or system, or to affect its safety or effectiveness.

www.fairchildsemi.com