

FS8S0765RCB Fairchild Power Switch (FPS™)

Features

- Burst Mode Operation to Reduce the Power Consumption in the Standby Mode
- External pin for Synchronization and Soft Start
- Wide Operating Frequency Range up to 150kHz
- Low Start-up Current (Max:80μA)
- Low Operating Current (Max:15mA)
- Pulse by Pulse Current Limiting
- Over-Voltage Protection (Auto Restart Mode)
- Overload Protection (Auto Restart Mode)
- Abnormal Over-Current Protection (Auto Restart Mode)
- Internal Thermal Shutdown (Auto Restart Mode)
- Under-Voltage Lockout
- Internal High-Voltage SenseFET

Applications

- SMPS for Monitor

Description

FS8S0765RCB is a Fairchild Power Switch (FPS) that is specially designed for off-line SMPS of CRT monitors with minimal external components. This device is a current mode pulse-width modulated (PWM) controller combined with a high-voltage power SenseFET in a single package. The PWM controller features integrated oscillator to be synchronized with the external sync signal, under-voltage lockout, optimized gate driver, temperature compensated precise current sources for the loop compensation. This device also includes various fault-protection, circuits such as over voltage protection, overload protection, abnormal over current protection and over-temperature protection. Compared with a discrete MOSFET and PWM controller solution, FPS can reduce total cost, component count, size, weight, while increasing efficiency, productivity, and system reliability. This device is well suited for the cost-effective monitor power supply.

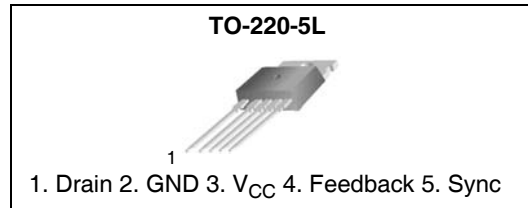

Ordering Information

Product Number	Package	Marking Code	BV _{DSS}	R _{DS(ON)}
FS8S0765RCBTU ⁽¹⁾	TO-220-5L	8S0765RC	650V	1.6Ω
FS8S0765RCBYDTU ⁽²⁾	TO-220-5L (Forming)			

Notes:

1. TU: Non Forming Type
2. YDTU: Forming Type

FPS™ is a trademark of Fairchild Semiconductor Corporation.

Internal Block Diagram

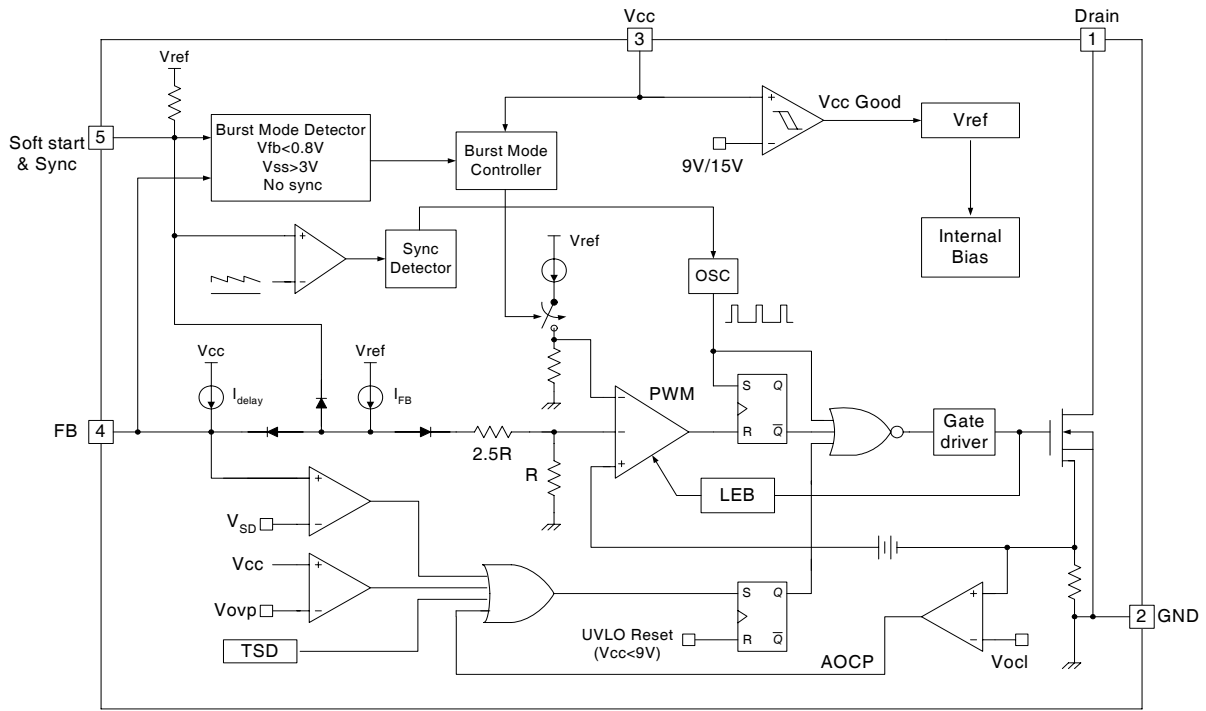

Figure 1. Functional Block Diagram

Pin Configuration

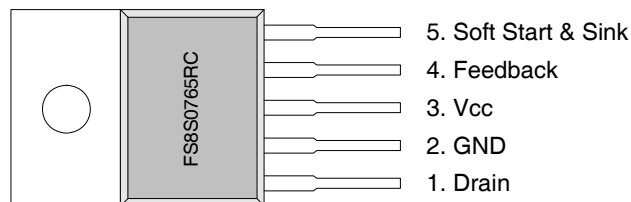

Figure 2. Pin Configuration (Top View)

Pin Definitions

Pin Number	Pin Name	Pin Function Description
1	Drain	SenseFET Drain. High voltage power SenseFET drain connection. This pin is designed to drive the transformer directly.
2	GND	Ground. Control ground and the SenseFET source.
3	Vcc	Supply Voltage. Supply input. This pin provides internal operating current for both start-up and steady-state operation.
4	Feedback	Feedback. Internally connected to the inverting input of the PWM comparator. For stable operation, a capacitor should be placed between this pin and GND. If the voltage of this pin reaches 7.5V, the overload protection is activated, resulting in shutdown of FPS.
5	Soft Start & Sync	Soft Start and Sync. For soft-start and synchronization to the external sync signal.

Absolute Maximum Ratings

The "Absolute Maximum Ratings" are those values beyond which the safety of the device cannot be guaranteed. The device should not be operated at these limits. The parametric values defined in the Electrical Characteristics tables are not guaranteed at the absolute maximum ratings. The "Recommended Operating Conditions" table defines the conditions for actual device operation. ($T_A = 25^\circ\text{C}$, unless otherwise specified)

Symbol	Parameter	Value	Unit
V_{DSS}	Drain-Source (GND) Voltage ⁽¹⁾	650	V
V_{DGR}	Drain-Gate Voltage ($R_{GS}=1M\Omega$)	650	V
V_{GS}	Gate-Source (GND) Voltage	± 30	V
I_{DM}	Drain Current Pulsed ⁽²⁾	28	A_{DC}
E_{AS}	Single Pulsed Avalanche Energy ⁽³⁾	370	mJ
I_{AS}	Single Pulsed Avalanche Current ⁽⁴⁾	17	A
I_D	Continuous Drain Current ($T_c = 25^\circ\text{C}$)	7	A_{DC}
I_D	Continuous Drain Current ($T_c=100^\circ\text{C}$)	4.5	A_{DC}
V_{CC}	Supply Voltage	40	V
V_{FB}	Input Voltage Range	-0.3 to V_{CC}	V
V_{S-S}		-0.3 to 10	V
P_D (Watt H/S)	Total Power Dissipation	145	W
Derating		1.16	$W/^\circ\text{C}$
T_j	Operating Junction Temperature	+150	$^\circ\text{C}$
T_A	Operating Ambient Temperature	-25 to +85	$^\circ\text{C}$
T_{STG}	Storage Temperature Range	-55 to +150	$^\circ\text{C}$

Notes:

- $T_j=25^\circ\text{C}$ to 150°C
- Repetitive rating: Pulse width limited by maximum junction temperature
- $L=14\text{mH}$, starting $T_j=25^\circ\text{C}$
- $L=13\mu\text{H}$, starting $T_j=25^\circ\text{C}$

Electrical Characteristics (SenseFET part)

($T_A = 25^\circ\text{C}$ unless otherwise specified)

Symbol	Parameter	Condition	Min.	Typ.	Max.	Unit
BV_{DSS}	Drain Source Breakdown Voltage	$V_{GS}=0V, I_D=250\mu A$	650	-	-	V
I_{DSS}	Zero Gate Voltage Drain Current	$V_{DS}=650V, V_{GS}=0V$	-	-	200	μA
		$V_{DS}=520V, V_{GS}=0V, T_C=125^\circ C$	-	-	300	μA
$R_{DS(ON)}$	Static Drain Source On Resistance ⁽¹⁾	$V_{GS}=10V, I_D=3.5A$	-	1.4	1.6	W
g_{fs}	Forward Transconductance	$V_{DS}=40V, I_D=3.5A$	-	8	-	mho
C_{iss}	Input Capacitance	$V_{GS}=0V, V_{DS}=25V, f = 1MHz$	-	1415	-	pF
C_{oss}	Output Capacitance		-	100	-	
C_{rss}	Reverse Transfer Capacitance		-	15	-	
$t_d(on)$	Turn On Delay Time	$V_{DD}=325V, I_D=6.5A$ ⁽²⁾	-	25	-	nS
t_r	Rise Time		-	60	-	
$t_d(off)$	Turn Off Delay Time		-	115	-	
t_f	Fall Time		-	65	-	
Q_g	Total Gate Charge (Gate-Source+Gate-Drain)	$V_{GS}=10V, I_D=6.5A, V_{DS}=325V$ ⁽²⁾	-	40	-	nC
Q_{gs}	Gate-Source Charge		-	7	-	
Q_{gd}	Gate-Drain (Miller) Charge		-	12	-	

Note:

1. Pulse test: Pulse width $\leq 300\mu S$, duty 2%
2. MOSFET switching time is essentially independent of operating temperature.

Electrical Characteristics (Continued)(T_A=25°C unless otherwise specified)

Symbol	Parameter	Condition	Min.	Typ.	Max.	Unit
UVLO Section						
V _{START}	Start Threshold Voltage	V _{FB} =GND	14	15	16	V
V _{STOP}	Stop Threshold Voltage	V _{FB} =GND	8	9	10	V
Oscillator Section						
F _{OSC}	Initial Frequency		18	20	22	kHz
F _{STABLE}	Voltage Stability	12V ≤ V _{CC} ≤ 23V	0	1	3	%
ΔF _{OSC}	Temperature Stability ⁽¹⁾	-25°C ≤ T _A ≤ 85°C	0	±5	±10	%
D _{MAX}	Maximum Duty Cycle		92	95	98	%
D _{MIN}	Minimum Duty Cycle		-	-	0	%
Feedback Section						
I _{FBSO}	Feedback Source Current	V _{FB} =GND	0.7	0.9	1.1	mA
I _{FBSI}	Feedback Sink Current	V _{FB} =4V, V _{CC} =19V	2.4	3.0	3.6	mA
V _{SD}	Shutdown Feedback Voltage	V _{FB} ≥ 6.9V	6.9	7.5	8.1	V
I _{delay}	Shutdown Delay Current	V _{FB} =5V	1.6	2.0	2.4	μA
Protection Section						
V _{OV}	Over Voltage Protection	V _{CC} ≥ 27V	34	37	-	V
V _{OCL}	Over Current Latch Voltage ⁽²⁾		0.95	1.0	1.05	V
TSD	Thermal Shutdown Temp. ⁽¹⁾		140	160	-	°C
Sync & Soft-start Section						
V _{SS}	Soft start Voltage	V _{FB} =2	4.7	5.0	5.3	V
I _{SS}	Soft start Current	V _{SS} =0V	0.8	1.0	1.2	mA
V _{SH}	Sync High Threshold Voltage	V _{CC} =16V, V _{FB} =5V	6.7	7.2	7.9	V
V _{SL}	Sync Low Threshold Voltage	V _{CC} =16V, V _{FB} =5V	5.4	5.8	6.2	V
Burst Mode Section (DPMS Mode)						
V _{BUH}	Burst Mode High Threshold Voltage	V _{FB} =0V	11.6	12	12.6	V
V _{BUL}	Burst Mode Low Threshold Voltage	V _{FB} =0V	10.6	11	11.6	V
V _{BUFB}	Burst Mode Enable FB Voltage	V _{CC} =10.5V	0.9	1.0	1.1	V
V _{BUSS}	Burst Mode Enable S_S Voltage	V _{CC} =10.5V, V _{FB} =0V	2.5	3.0	3.5	V
T _{BUDT}	Burst Mode Enable Delay Time	V _{CC} =10.5V, V _{FB} =0V	-	0.5	-	ms
F _{BU}	Burst Mode Frequency	V _{CC} =10.5V, V _{FB} =0V	32	40	48	kHz
Current Limit (Self-Protection) Section						
I _{OVER}	Peak Current Limit ⁽³⁾		3.52	4.0	4.48	A
I _{BU_PK}	Burst Mode Peak Current Limit		0.45	0.6	0.75	A
Total Device Section						
I _{START}	Start Up Current	V _{CC} =V _{start} -0.1V	-	40	80	μA
I _{OP}	Operating Supply Current ⁽⁴⁾	V _{FB} =GND, V _{CC} =16V	-	9	15	mA
I _{OP(MIN)}		V _{FB} =GND, V _{CC} =12V				
I _{OP(MAX)}		V _{FB} =GND, V _{CC} =27V				

Note:

1. These parameters, although guaranteed at the design, are not tested in mass production.
2. These parameters, although guaranteed, are tested in EDS (wafer test) process.
3. These parameters indicate inductor current.
4. These parameters are the current flowing in the control IC.

Typical Performance Characteristics (Control Part)

(These characteristic graphs are normalized at $T_A = 25^\circ\text{C}$)

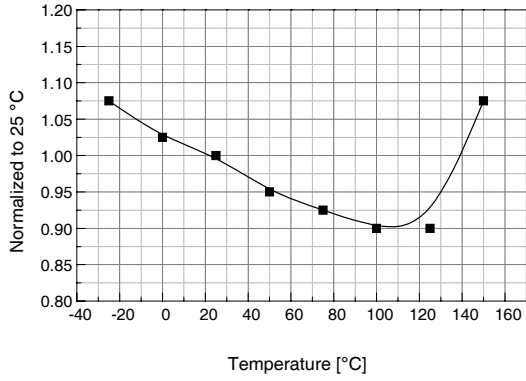

Figure 3. Start Up Current vs. Temp.

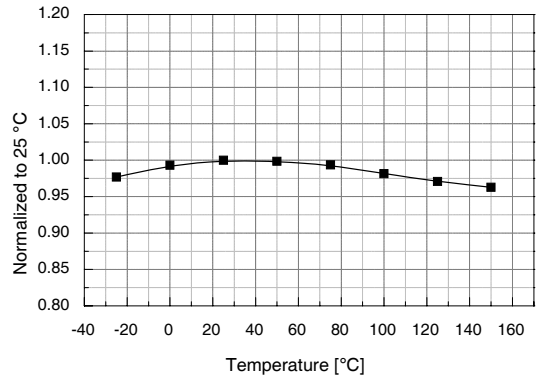

Figure 4. Operating Supply Current vs. Temp.

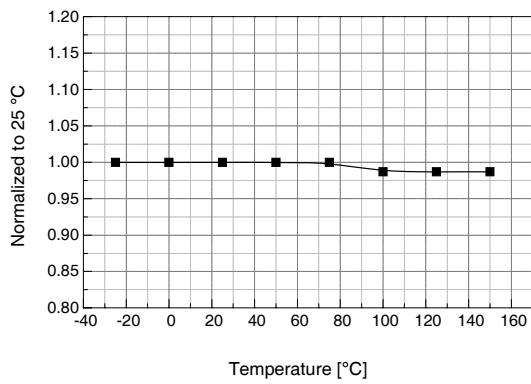

Figure 5. Start Threshold Voltage vs. Temp.

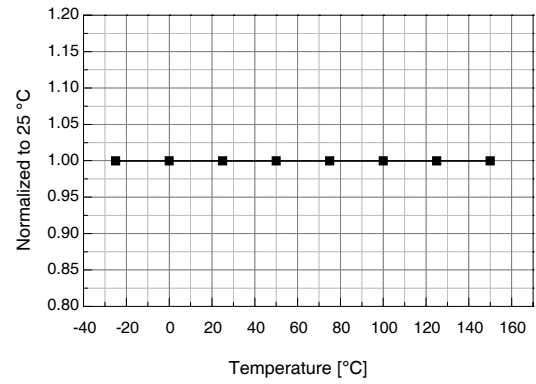

Figure 6. Stop Threshold Voltage vs. Temp.

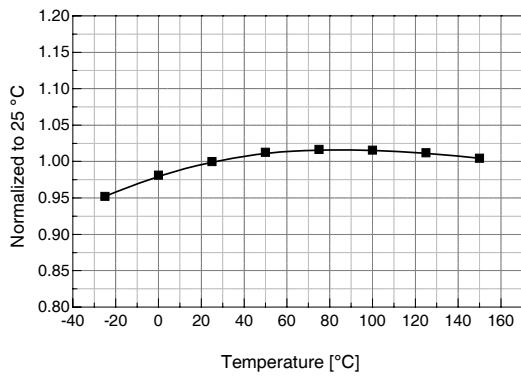

Figure 7. Initial Frequency vs. Temp.

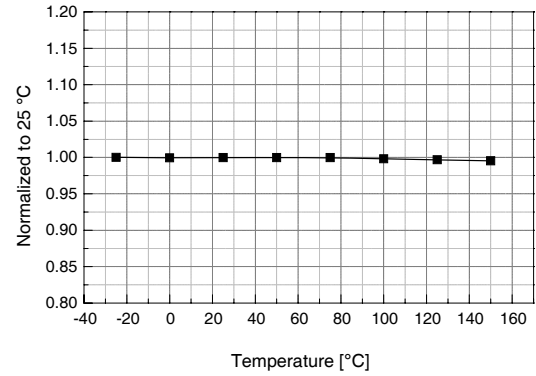

Figure 8. Maximum Duty Cycle vs. Temp.

Typical Performance Characteristics (Continued)

(These characteristic graphs are normalized at $T_A = 25^\circ\text{C}$)

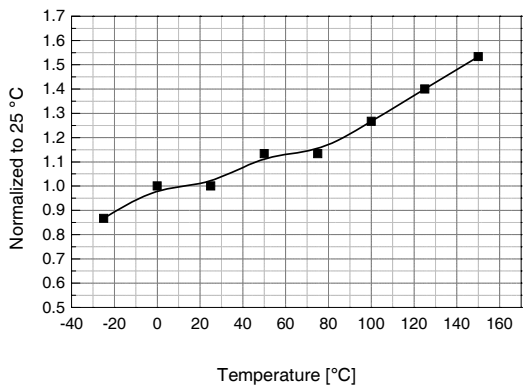

Figure 9. Feedback Offset Voltage vs. Temp.

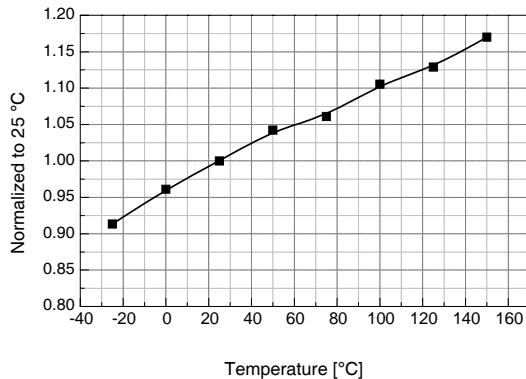

Figure 10. Feedback Sink Current vs. Temp.

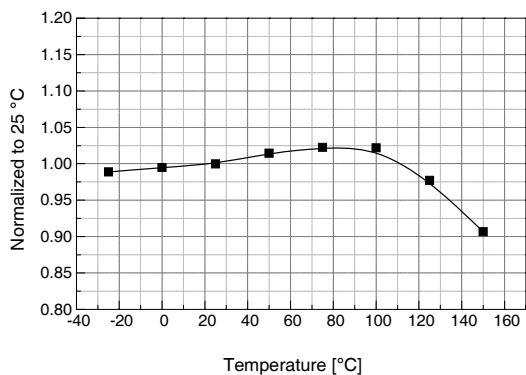

Figure 11. Shutdown Delay Current vs. Temp.

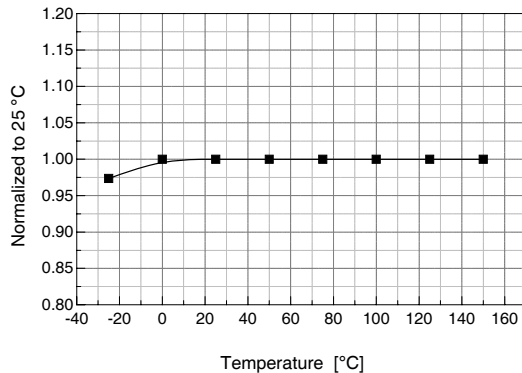

Figure 12. Shutdown Feedback Voltage vs. Temp.

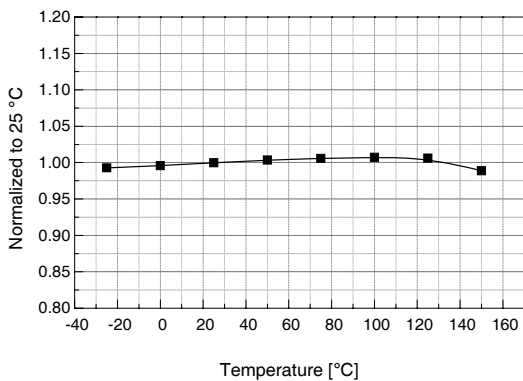

Figure 13. Soft Start Voltage vs. Temp.

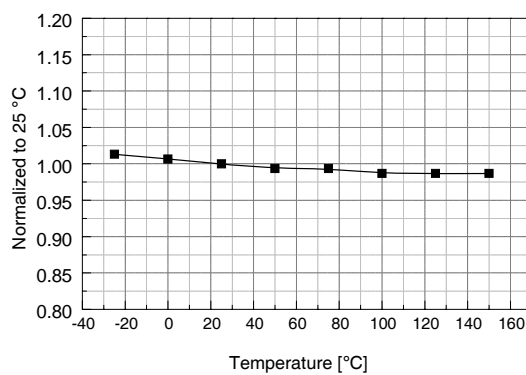

Figure 14. Over Voltage Protection vs. Temp.

Typical Performance Characteristics (Continued)

(These characteristic graphs are normalized at $T_A = 25^\circ\text{C}$)

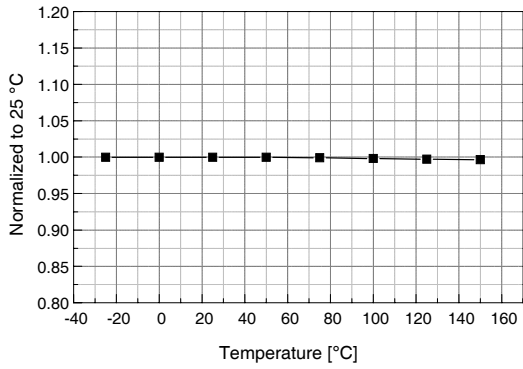

Figure 15. Normal Mode Regulation Voltage vs. Temp.

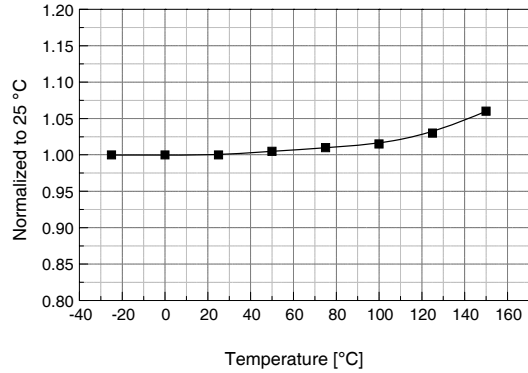

Figure 16. Peak Current vs. Temp.

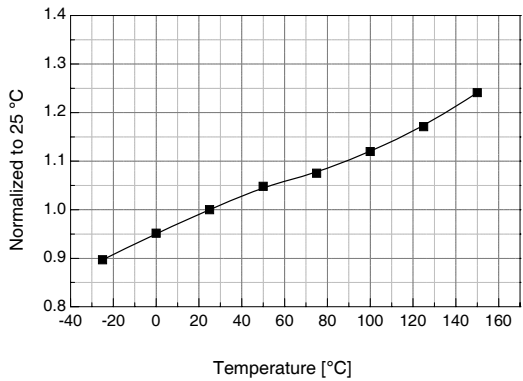

Figure 17. Feedback Sink Current vs. Temp.

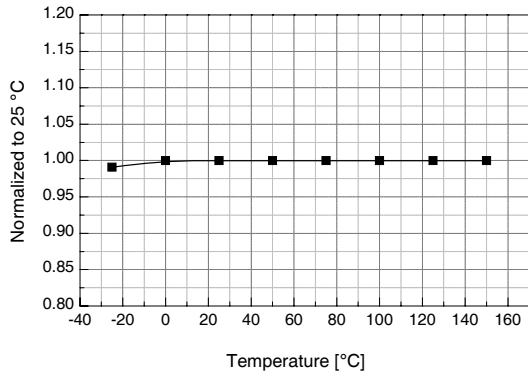

Figure 18. Burst Mode Low Threshold Voltage vs. Temp.

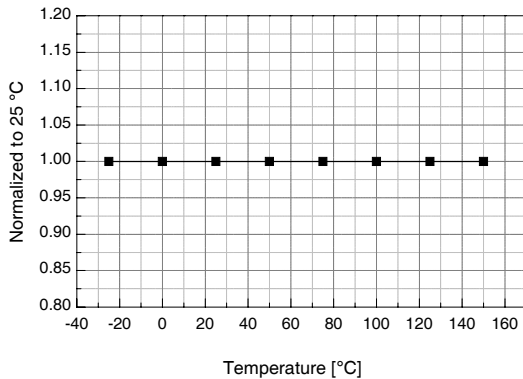

Figure 19. Burst Mode High Threshold Voltage vs. Temp.

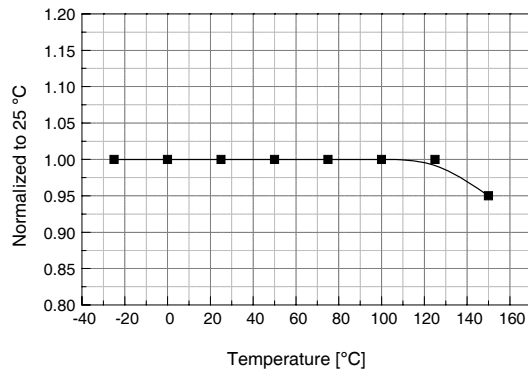

Figure 20. Burst Mode Enable Voltage vs. Temp.

Typical Performance Characteristics (Continued)

(These characteristic graphs are normalized at $T_A = 25^\circ\text{C}$)

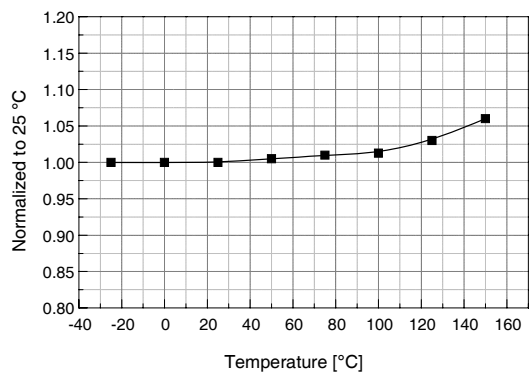

Figure 21. Burst Mode Peak Current vs. Temp.

Functional Description

1. Start up: To guarantee stable operation of the control IC, FS8S0765RCB has UVLO circuit with 6V hysteresis band. Figure 22 shows the relation between the supply current (I_{cc}) and the supply voltage (V_{cc}). Before V_{cc} reaches 15V, the FPS consumes only startup current of 80mA, which is usually provided by the DC link through the start-up resistor. When V_{cc} reaches 15V, the FPS begins operation and the operating current increases to 15mA as shown. Once the control IC starts operation, it continues normal operation until V_{cc} goes below the stop voltage of 9V.

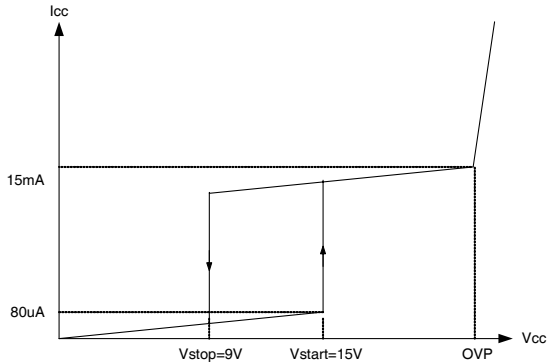

Figure 22. High Voltage Current Source

2. Feedback Control: FS8S0765RCB employs primary side regulation, which permits elimination of feedback circuit components in the secondary side, such as optocoupler and TL431. Figure 23 shows the primary side control circuit. The primary side regulation voltage (V_{psr}) is controlled to the breakdown voltage of zener diode (D_z). Because current mode control is employed, the drain current of the power MOSFET is limited by the inverting input of PWM comparator (V_{fb}^*). When MOSFET turns on, usually there exists high current spike in the MOSFET current caused by primary-side capacitance and secondary-side rectifier reverse recovery. To prevent premature termination of the switching pulse due to the current spike, the FPS employs leading edge blanking (LEB). The leading edge blanking circuit inhibits the PWM comparator for a short time after the MOSFET is turned on.

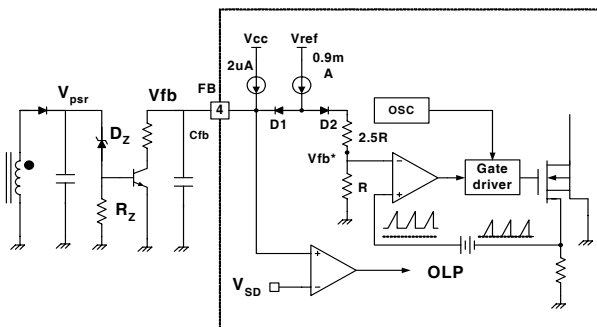

Figure 23. Pulse-Width Modulation (PWM) Circuit

3. Protection function: FS8S0765RCB has four self-protective functions such as abnormal over current protection (AOCP), overload protection (OLP), over-voltage protection (OVP) and thermal shutdown (TSD). Because these protection circuits are fully integrated into the IC without external components, the reliability can be improved without cost increase. In the event of these fault conditions, the FPS enters into auto-restart operation. Once the fault condition occurs, switching operation is terminated and MOSFET remains off, which forces V_{cc} to be reduced. When V_{cc} reaches 9V, the protection is reset and the supply current reduces to 80 μ A. Then, V_{cc} begin to increase with the current provided through the start-up resistor. When V_{cc} reaches 15V, the FPS resumes normal operation if the fault condition is removed. In this manner, the auto-restart alternately enables and disables the switching of the power MOSFET until the fault condition is eliminated, as illustrated in Figure 24.

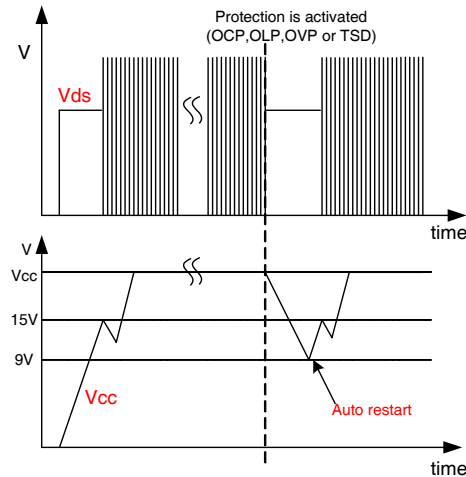

Figure 24. Auto restart operation after protection

3.1 Abnormal Over Current Protection (AOCP): When the secondary rectifying diodes or the transformer pins are shorted, a steep current with extremely high di/dt can flow during the LEB time. Therefore, the abnormal over-current protection (AOCP) block is added to ensure the reliability, as shown in Figure 25. It turns off the SenseFET within 300ns after the abnormal over-current condition is sensed.

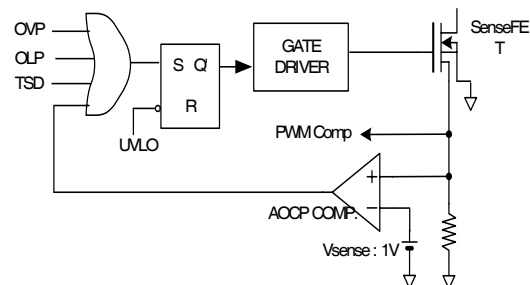

Figure 25. AOCP block

3.2 Overload Protection (OLP): When the load current exceeds a preset level for longer than the pre-determined time, protection circuit should be activated to protect the SMPS. Because of the pulse-by-pulse current limit capability, the maximum peak current through the SMPS is limited, and the maximum input power is restricted with a given input voltage. If the output consumes beyond this maximum power, the output voltage, together with primary side regulation voltage, decrease below the set voltage. This reduces the current through primary side regulation transistor, which increases feedback voltage (Vfb). If Vfb exceeds 2.7V, D1 is blocked and the 2μA current source starts to charge Cfb slowly, compared to when the 0.9mA current source charges Cfb. In this condition, Vfb continues increasing until it reaches 7.5V and the switching operation is terminated at that time, as shown in Figure 27. The delay time for shutdown is the time required to charge Cfb from 2.7V to 7.5V with 2μA.

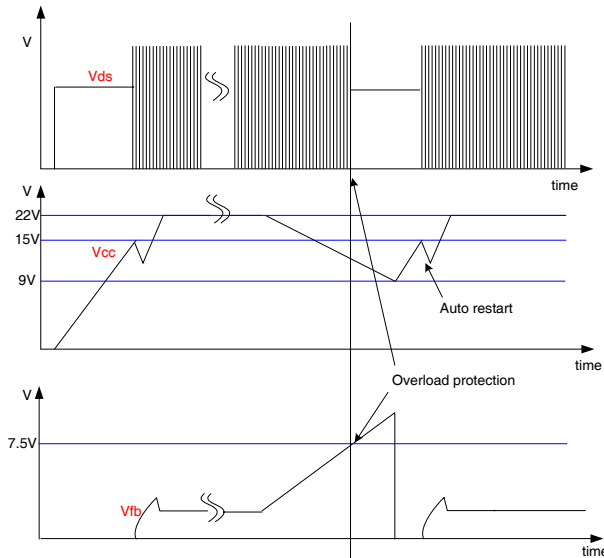

Figure 26. The waveforms at the OLP and auto restart

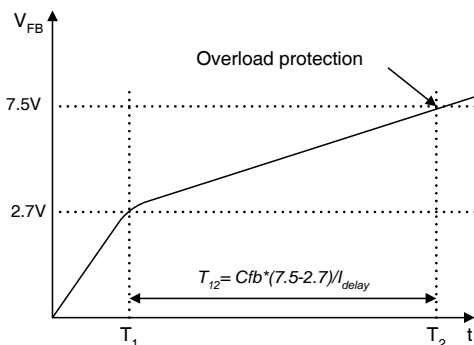

Figure 27. Overload protection

3.3 Over Voltage Protection (OVP): In case of malfunction in the primary side feedback circuit or feedback loop open caused by a defect of solder, the current through primary side control transistor becomes almost zero. Then, Vfb climbs up in a similar manner to the overload situation, forcing the preset maximum current to be supplied to the secondary side until the over load protection is activated. Because more energy than required is provided to the output, the output voltage may exceed the rated voltage before the over load protection is activated, resulting in the breakdown of the devices in the secondary side. To prevent this situation, an over-voltage protection (OVP) circuit is employed. When the Vcc voltage touches 37V, the OVP block is activated.

3.4 Thermal Shutdown (TSD): The SenseFET and the control IC are built in one package. This allows the control IC to detect the heat generation from the SenseFET. If the temperature exceeds approximately 160°C, the thermal shutdown is activated.

4. Soft Start: Figure 28 shows the soft-start circuit. During the initial start up, the 0.9 mA current source leaks out through C_{ss} and R_{ss}. As C_{ss} is charged, the leakage current decreases. By choosing much bigger C_{ss} than C_{fb}, it is possible to increase the feedback voltage slowly, forcing the SenseFET current to increase slowly. After C_{ss} reaches its steady state value, D3 is blocked and the soft switching circuit is decoupled from the feedback circuit. If the value of C_{ss} is too large, there is possibility that Vfb increases to 7.5V, activating the over load protection during soft start time. To avoid this situation, it is recommended that the value of C_{ss} should not exceed 100 times the C_{fb}.

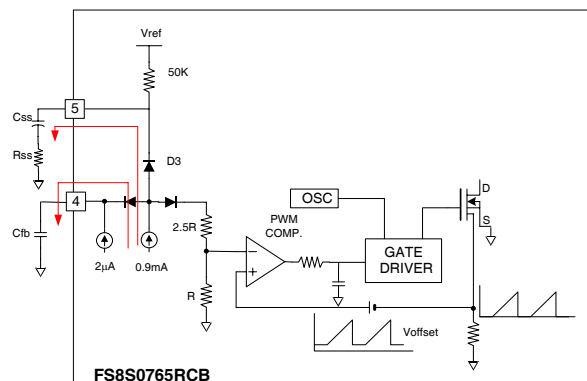

Figure 28. The circuit for the soft start

5. Synchronization: To reduce the effect of switching noise on the screen, the SMPS for monitor synchronizes its switching frequency to an external signal, typically the horizontal sync flyback signal. The switching frequency of the FPS can vary from 20 kHz to 150 kHz according to the external sync signal. The internal sync comparator detects the sync signal and determines the SenseFET turn-on time. The SenseFET is turned on at the negative edge of the sync comparator output. The reference voltage of the sync comparator is an inverted saw tooth with a base frequency of 20kHz and a varying range between 5.8V and 7.2V, as shown in the Figure 29. The inverted saw tooth reference gets rid of the excessive switching noise at the first synchronized turn-on. The external sync signal is recommended to have an amplitude higher than 4.2V.

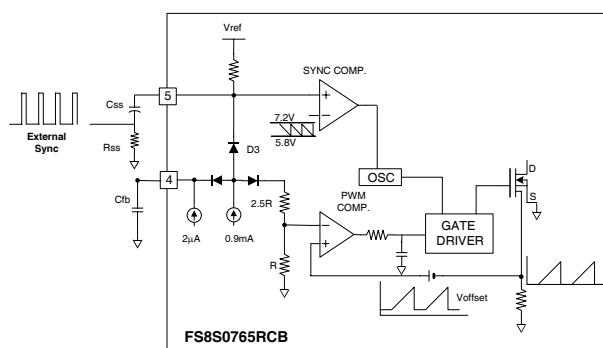

Figure 29. The circuit for the synchronization with external sync

6. Burst mode operation: To minimize the power dissipation at standby mode, FS8S0765RCB has a burst mode operation. In burst mode, the FPS reduces the effective switching frequency and output voltage. The FPS enters burst mode when the voltage of the soft start pin is higher than 3V. No sync signal is applied and the feedback voltage is lower than 1V. During the burst mode operation, Vcc is hysteresis controlled between 11V and 12V. Once the FPS enters burst mode, it stops switching operation until Vcc drops to 11V. When Vcc reaches 11V, the FPS starts switching with switching frequency of 40kHz and peak MOSFET current of 0.6A until Vcc reaches 12V. When Vcc reaches 12V, the switching operation is terminated again until Vcc reduces to 11V. Figure 30 shows operating waveforms. The soft start during the initial start-up is shown in the section 1. During this period, there is no external sync signal and the switching frequency is 20kHz. The section 2 represents the normal mode operation. The switching frequency is synchronized with the external sync signal. In the section 3, the external sync signal is removed; however, the load still exists and the feedback voltage (Vfb) is higher than 1V. In this period, the FPS does the normal switching operation with switching frequency of 20kHz. The section 4 and 5 show the burst mode

operation. At the end of the section 3, the load is eliminated and the feedback voltage (Vfb) drops below 1V, forcing the FPS to stop switching operation. During the section 4, Vcc goes down to 11V. During section 5, Vcc is hysteresis controlled between 11V and 12V. When the external sync signal is applied on the pin 5, the FPS resumes normal operation. To minimize the power consumption in standby mode, it is recommended to set the value of Vcc during normal operation as high as possible (about 29V).

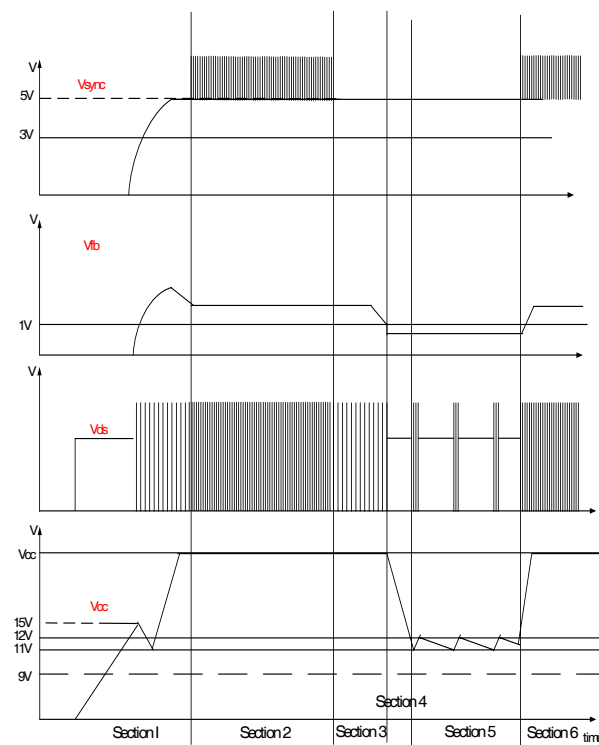
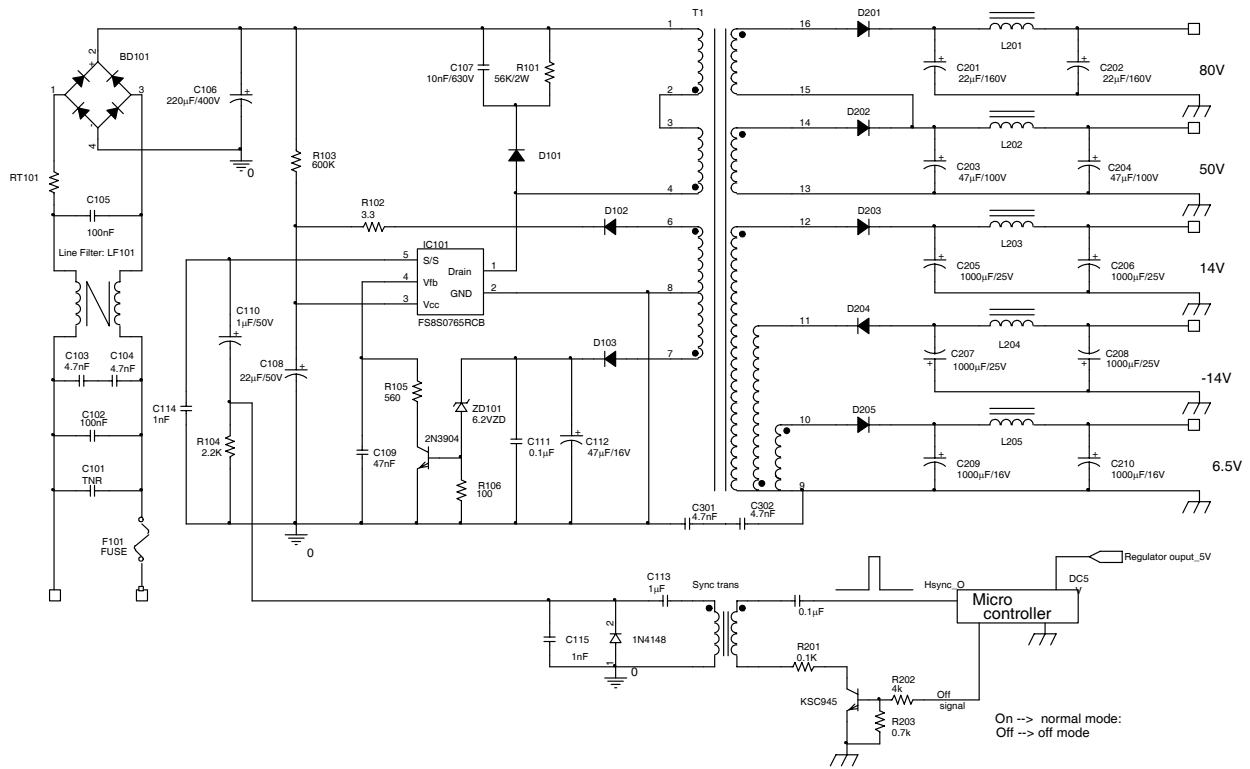

Figure 30. The operation of the FS8S0765RCB at the normal mode and the off mode

Typical Application Circuit

1. 80W Universal Input Power Supply For CRT Monitor



2. Transformer Schematic Diagram

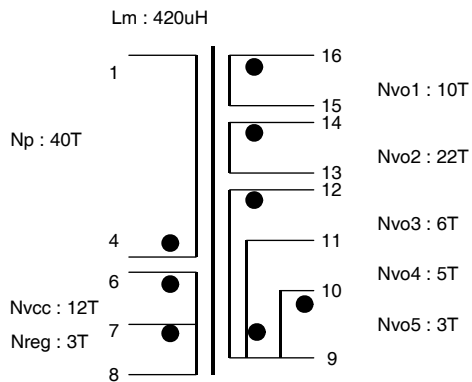

3. Winding Specification

No	Pin (s→f)	Wire	Turns	Winding Method
Np1	4 → 1	0.3 ^φ × 1	40	Solenoid Winding
Insulation: Polyester Tape t = 0.050mm, 2 Layers				
Nvo1	16 → 15	0.3 ^φ × 1	10	Center Winding
Insulation: Polyester Tape t = 0.050mm, 2 Layers				
Nreg	7 → 8	0.2 ^φ × 1	3	Solenoid Winding
Insulation: Polyester Tape t = 0.050mm, 2 Layers				
Nvo2	14 → 13	0.3 ^φ × 3	22	Center Winding
Insulation: Polyester Tape t = 0.050mm, 2 Layers				
Np2	4 → 1	0.3 ^φ × 1	40	Solenoid Winding
Insulation: Polyester Tape t = 0.050mm, 2 Layers				
Nvo3	12 → 9	0.3 ^φ × 2	6	Solenoid Winding
Insulation: Polyester Tape t = 0.050mm, 2 Layers				
Nvo4	9 → 11	0.3 ^φ × 1	5	Solenoid Winding
Insulation: Polyester Tape t = 0.050mm, 2 Layers				
Nvo5	10 → 9	0.3 ^φ × 2	3	Solenoid Winding
Insulation: Polyester Tape t = 0.050mm, 2 Layers				
Nvcc	6 → 8	0.2 ^φ × 1	12	Solenoid Winding
Outer Insulation: Polyester Tape t = 0.050mm, 2 Layers				

4. Electrical Characteristics

	Pin	Specification	Remarks
Inductance	1 - 4	420μH ± 10%	300kHz, 1V
Leakage Inductance	1 - 4	5μH Max	2 nd all short

5. Core & Bobbin

- Core: EER 3540
- Bobbin: EER3540
- Ae(mm²): 107

6. Demo Circuit Part List

Part	Value	Note	Part	Value	Note
Fuse			C201	22nF/160V	Electrolytic Capacitor
F101	3A/250V		C202	22nF/160V	Electrolytic Capacitor
NTC			C203	47nF/100V	Electrolytic Capacitor
RT101	10D-9		C204	47nF/100V	Electrolytic Capacitor
Resistor			C205	1000nF/25V	Electrolytic Capacitor
R101	56kΩ	2W	C206	1000nF/25V	Electrolytic Capacitor
R102	3.3Ω	1/4W	C207	1000nF/25V	Electrolytic Capacitor
R103	600kΩ	1W	C208	1000nF/25V	Electrolytic Capacitor
R104	2.2kΩ	1/4W	C209	1000nF/25V	Electrolytic Capacitor
R105	0.56kΩ	1/4W	C210	1000nF/25V	Electrolytic Capacitor
R106	0.1kΩ	1/4W	C211	0.1μF/50V	Ceramic Capacitor
R201	0.1kΩ	1/4W	C301	4.7nF	AC Filter Capacitor
R202	4kΩ	1/4W	C302	4.7nF	AC Filter Capacitor
R203	0.7kΩ	1/4W			
			Sync trans	22mH	
Inductor					
L201 ~ L205	13uH				
Diode					
			D101	UF4007	
Capacitor			D102	TVR10G	
C101	471D10	TNR	D103	TVR10G	
C102	100nF	Box Capacitor	D201	UF4007	
C103	4.7nF	AC Filter Capacitor	D202	UF5404	
C104	4.7nF	AC Filter Capacitor	D203	UF5402	
C105	100nF	Box Capacitor	D204	UF5402	
C106	220μF/400V	Electrolytic Capacitor	D205	UF5401	
C107	10nF/630V	Ceramic Capacitor			
C108	22μF/50V	Electrolytic Capacitor	BD101	KBL406	Bridge Diode
C109	47nF/50V	Ceramic Capacitor	Line Filter		
C110	1μF/50V	Electrolytic Capacitor	LF101	24mH	
C111	0.1μF/50V	Ceramic Capacitor	IC		
C112	47μF/50V	Electrolytic Capacitor	IC101	FS8S0765RC	(7A, 650V)
C113	1μF/50v	Electrolytic Capacitor	IC201	KSC945	NPN Transistor
C114	1nF/50V	Ceramic Capacitor			
C115	1nF/50V	Ceramic Capacitor			

Package Dimensions

TO-220-5L

Dimensions in millimeters

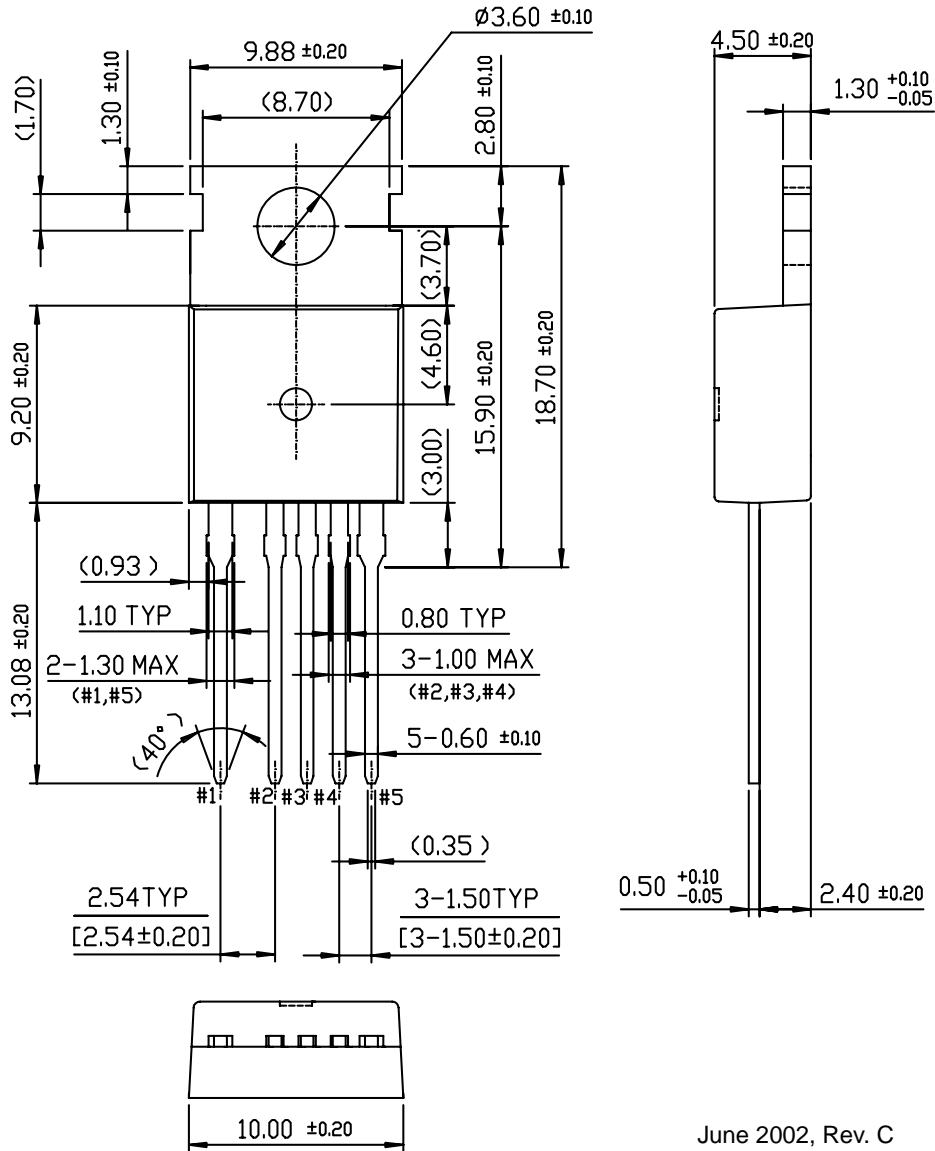

June 2002, Rev. C

Package Dimensions (Continued)

TO-220-5L (Forming)

Dimensions in millimeters

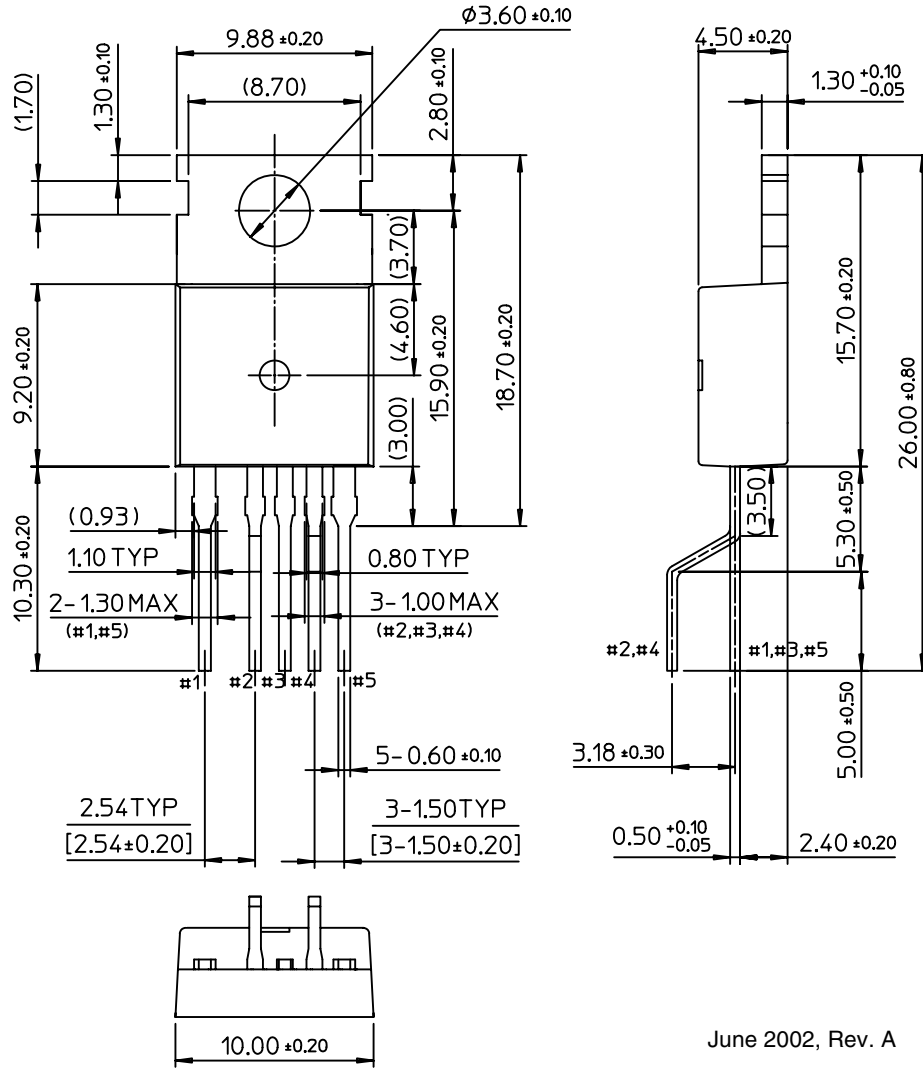

June 2002, Rev. A

TRADEMARKS

The following are registered and unregistered trademarks Fairchild Semiconductor owns or is authorized to use and is not intended to be an exhaustive list of all such trademarks.

ACE ^x ™	FAST [®]	ISOPLANAR™	PowerEdge™	SuperFET™
ActiveArray™	FAST ^r ™	LittleFET™	PowerSaver™	SuperSOT™-3
Bottomless™	FPS™	MICROCOUPLER™	PowerTrench [®]	SuperSOT™-6
Build it Now™	FRFET™	MicroFET™	QFET [®]	SuperSOT™-8
CoolFET™	GlobalOptoisolator™	MicroPak™	QST™	SyncFET™
CROSSVOLT™	GTO™	MICROWIRE™	QT Optoelectronics™	TCM™
DOME™	HiSeC™	MSX™	Quiet Series™	TinyLogic [®]
EcoSPARK™	I ² C™	MSXPro™	RapidConfigure™	TINYOPTO™
E ² C MOS™	i-Lo™	OCX™	RapidConnect™	TruTranslation™
EnSigna™	ImpliedDisconnect™	OCXPro™	μSerDes™	UHC™
FACT™	IntelliMAX™	OPTOLOGIC [®]	ScalarPump™	UniFET™
FACT Quiet Series™		OPTOPLANAR™	SILENT SWITCHER [®]	UltraFET [®]
Across the board. Around the world.™		PACMAN™	SMART START™	VCX™
The Power Franchise [®]		POP™	SPM™	Wire™
Programmable Active Droop™		Power247™	Stealth™	

DISCLAIMER

FAIRCHILD SEMICONDUCTOR RESERVES THE RIGHT TO MAKE CHANGES WITHOUT FURTHER NOTICE TO ANY PRODUCTS HEREIN TO IMPROVE RELIABILITY, FUNCTION OR DESIGN. FAIRCHILD DOES NOT ASSUME ANY LIABILITY ARISING OUT OF THE APPLICATION OR USE OF ANY PRODUCT OR CIRCUIT DESCRIBED HEREIN; NEITHER DOES IT CONVEY ANY LICENSE UNDER ITS PATENT RIGHTS, NOR THE RIGHTS OF OTHERS. THESE SPECIFICATIONS DO NOT EXPAND THE TERMS OF FAIRCHILD'S WORLDWIDE TERMS AND CONDITIONS, SPECIFICALLY THE WARRANTY THEREIN, WHICH COVERS THESE PRODUCTS.

LIFE SUPPORT POLICY

FAIRCHILD'S PRODUCTS ARE NOT AUTHORIZED FOR USE AS CRITICAL COMPONENTS IN LIFE SUPPORT DEVICES OR SYSTEMS WITHOUT THE EXPRESS WRITTEN APPROVAL OF FAIRCHILD SEMICONDUCTOR CORPORATION.

As used herein:

- Life support devices or systems are devices or systems which, (a) are intended for surgical implant into the body, or (b) support or sustain life, or (c) whose failure to perform when properly used in accordance with instructions for use provided in the labeling, can be reasonably expected to result in significant injury to the user.
- A critical component is any component of a life support device or system whose failure to perform can be reasonably expected to cause the failure of the life support device or system, or to affect its safety or effectiveness.

PRODUCT STATUS DEFINITIONS

Definition of Terms

Datasheet Identification	Product Status	Definition
Advance Information	Formative or In Design	This datasheet contains the design specifications for product development. Specifications may change in any manner without notice.
Preliminary	First Production	This datasheet contains preliminary data, and supplementary data will be published at a later date. Fairchild Semiconductor reserves the right to make changes at any time without notice in order to improve design.
No Identification Needed	Full Production	This datasheet contains final specifications. Fairchild Semiconductor reserves the right to make changes at any time without notice in order to improve design.
Obsolete	Not In Production	This datasheet contains specifications on a product that has been discontinued by Fairchild semiconductor. The datasheet is printed for reference information only.

Rev. 119