

DESCRIPTION: 25 POS - MALE - SURFACE MOUNT

MATERIAL/FINISH:

SHELL: STEEL, NICKEL PLATED
 BRACKET: BRASS, NICKEL PLATED
 INSULATOR: NYLON 6T-UL 94V-0, BLACK, (TEMP. RESISTANCE 250° C FOR 60 SEC.)
 INSULATOR: PATONE #322C, COLOR = Pc99
 CONTACT: PHOSPHOR BRONZE, TIN PLATED
 GOLD FLASH - MATING AREA
 TIN - TERMINATING AREA

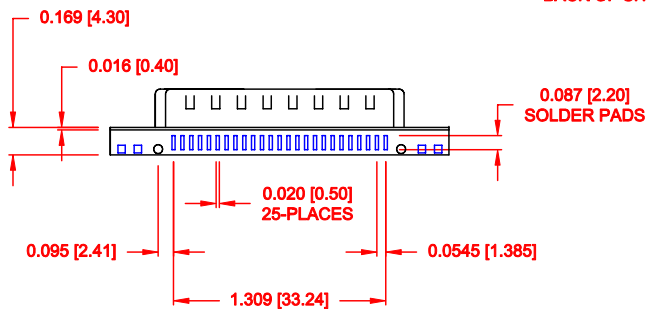
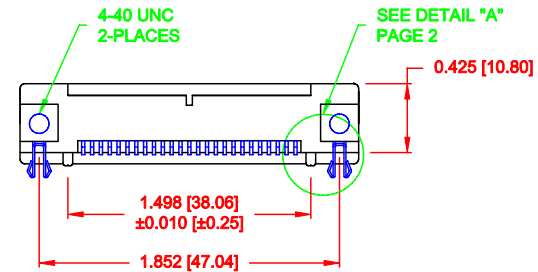
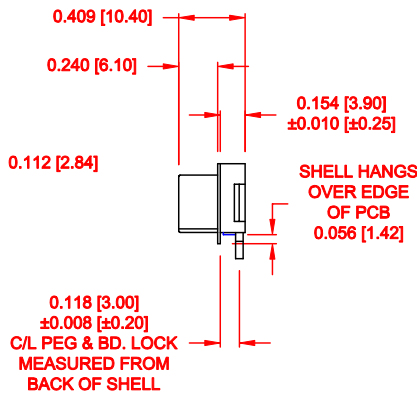
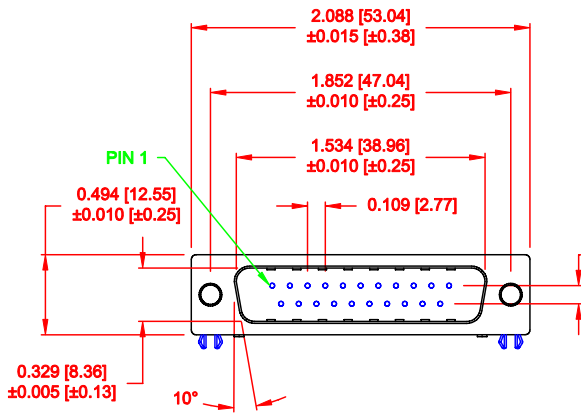

ELECTRICAL:

RATED CURRENT: 5 AMPS
 RATED VOLTAGE: 300VDC
 WITHSTANDING VOLTAGE: 500VAC (rms) FOR 1 Min.
 INSULATION RESISTANCE: > 1,000mOhms AT 500VDC
 CONTACT RESISTANCE: 13mOhms Max.
 DIELECTRIC STRENGTH: 1,000VAC FOR 1 MINUTE
 OPERATING TEMPERATURE: -55° ~ +105° C

DO NOT SCALE FROM DRAWING

RoHS COMPLIANT

	THESE DRAWINGS AND SPECIFICATIONS ARE THE PROPERTY OF NorComp AND SHALL NOT BE REPRODUCED, COPIED OR USED AS THE BASIS FOR THE MANUFACTURE OR SALE OF APPARATUS WITHOUT WRITTEN PERMISSION.		DRAWN: C. SMITH CHECKED:	DATE: 04-14-09 DATE:
	<h1>NorComp</h1>		SCALE: 1.5 : 1 DWG NO. 190-025-163R001	SHEET 1 OF 2 REV 6

DESCRIPTION: 25 POS PCB LAYOUT - SURFACE MOUNT - MALE

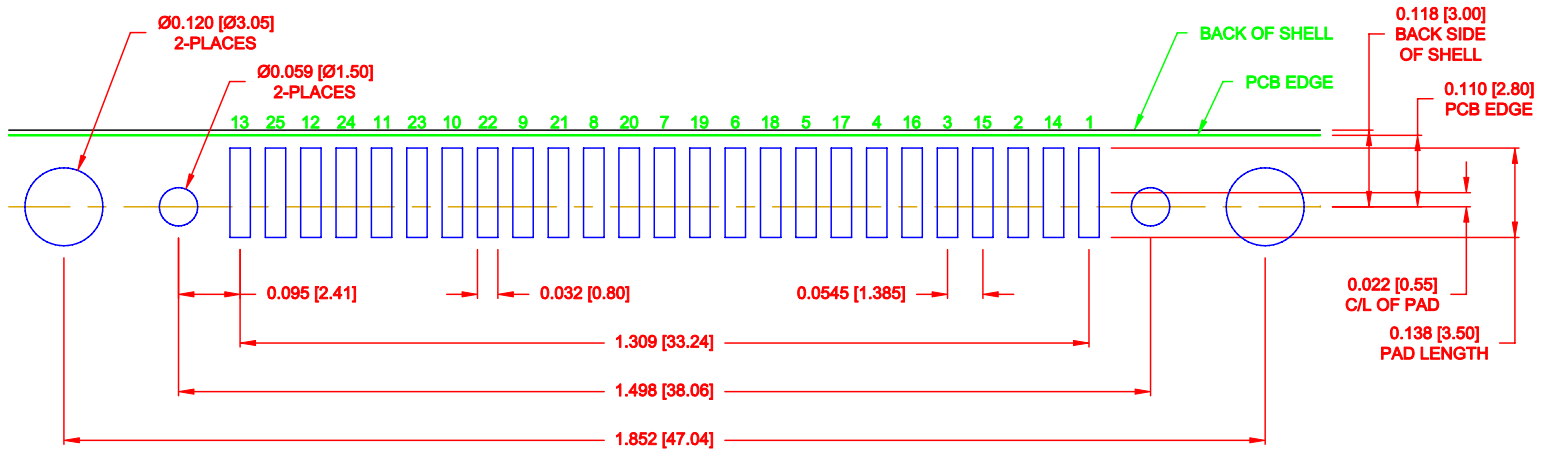

RECOMMENDED PCB LAYOUT

SCALE = 4 : 1

CONTACT ARRANGEMENT

13 25 12 24 11 23 10 22 9 21 8 20 7 19 6 18 5 17 4 16 3 15 2 14 1

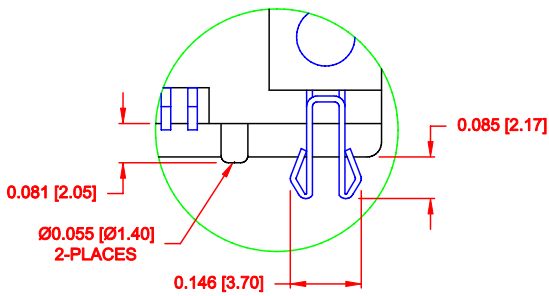

DETAIL "A"

SCALE = 3 : 1

DO NOT SCALE FROM DRAWING

	THESE DRAWINGS AND SPECIFICATIONS ARE THE PROPERTY OF NorComp AND SHALL NOT BE REPRODUCED, COPIED OR USED AS THE BASIS FOR THE MANUFACTURE OR SALE OF APPARATUS WITHOUT WRITTEN PERMISSION.		DRAWN: C. SMITH CHECKED:	DATE: 04-14-09 DATE:
	<h1>NorComp</h1>		SCALE: AS NOTED DWG NO. 190-025-163R001	SHEET 2 OF 2 REV 6