

DESCRIPTION: R/A - 0.318 - MALE - ECONOMY - D SUB

25-PIN SHOWN

No. OF PINS	DIMENSIONS			
	A	B	C	D
009	1.213	0.984	0.666	0.492
	30.80	24.99	16.92	12.50
015	1.541	1.312	0.994	0.656
	39.14	33.32	25.25	16.66
025	2.088	1.852	1.534	0.926
	53.04	47.04	38.96	23.52
037	2.729	2.500	2.181	1.250
	69.32	63.50	57.30	31.75

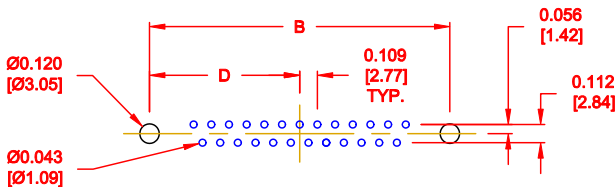
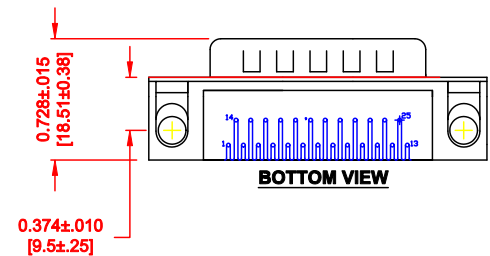
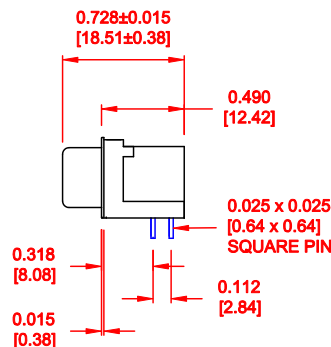
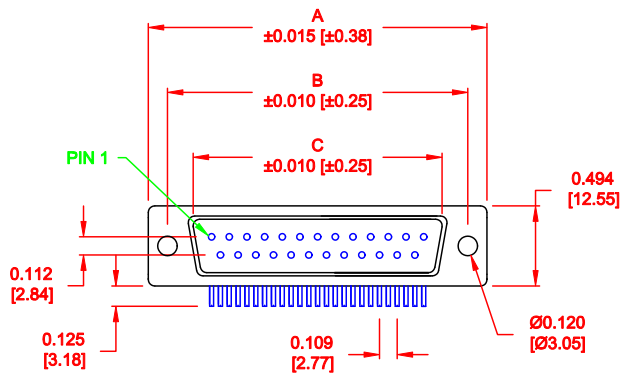

RECOMMENDED PCB LAYOUT

182-YYY-1 1 3 RYY 1

- SERIES
- No. of POSITIONS
- GENDER  
1 = MALE
- TERMINATION  
1 = PC MOUNT
- SHELL PLATING  
3 = NICKEL
- HARDWARE OPTIONS  
SEE PAGE 2
- PLATING OPTIONS  
1 = GOLD FLASH  
2 = 30u" GOLD

MATERIAL:

- SHELL: STEEL, NICKEL PLATED
- INSULATOR: UL 94V-O RATED, BLACK, 260° NYLON
- CONTACT: BRASS OR PHOSPHOR BRONZE

ELECTRICAL:

- CURRENT RATING: 5 AMPS
- DIELECTRIC STRENGTH: 1,000VAC rms
- INSULATION RESISTANCE: 1,000 MOHMS Min
- TEMPERATURE: -55°C TO +105°C
- CERTIFICATION: UL RECOGNIZED TO CATEGORY CODE ECBT2







GENERAL TOLERANCES  
 $\pm 0.006$  [0.15]  
 HOLE :  $\pm 0.005$  [0.13]

DO NOT SCALE FROM DRAWING

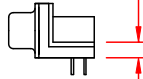
RoHS COMPLIANT

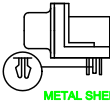
	THESE DRAWINGS AND SPECIFICATIONS ARE THE PROPERTY OF NorComp AND SHALL NOT BE REPRODUCED, COPIED OR USED AS THE BASIS FOR THE MANUFACTURE OF SALE OF APPARATUS WITHOUT WRITTEN PERMISSION.		DRAWN: <b>PAM JENKINS</b>	DATE: <b>03-17-05</b>
			CHECKED:	DATE:
<b>NorComp</b>		SCALE: 1 : 1	SHEET 1 OF 2	REV 6
		DWG NO. 182-YYY-113RYY1		

DESCRIPTION: RIGHT ANGLE HARDWARE OPTIONS

	 <p>0.141 ±0.020</p> <p>METAL SHELL WITH INSIDE GROUND STRAPS</p>	 <p>METAL SHELL</p>	 <p>METAL SHELL FORK BOARD LOCKS</p>
 <p>.120" DIA. HOLE</p>	16	43	N/A
 <p>4-40 FLUSH INSERT</p>	17	45	53 BOARD LOCKS IN HOLE
 <p>4-40 HEX STANDOFF FEMALE SCREWLOCK</p>	18	48	56 BOARD LOCKS IN HOLE
 <p>4-40 ROUND STANDOFF FEMALE SCREWLOCK</p>	N/A	N/A	N/A

DO NOT SCALE FROM DRAWING

RoHS COMPLIANT

	THESE DRAWINGS AND SPECIFICATIONS ARE THE PROPERTY OF NorComp AND SHALL NOT BE REPRODUCED, COPIED OR USED AS THE BASIS FOR THE MANUFACTURE OF SALE OF APPARATUS WITHOUT WRITTEN PERMISSION.		DRAWN: <b>PAM JENKINS</b>	DATE: <b>03-17-05</b>
			CHECKED:	DATE:
<h1>NorComp</h1>		SCALE: <b>1 : 1</b>	SHEET <b>2</b> OF <b>2</b>	REV <b>6</b>
		DWG NO. <b>182-YYY-113RYY1</b>		