

DESCRIPTION: MALE SOLDER CUP/STAMPED

SPECIFICATIONS:
MATERIALS:
 SHELL: STEEL, TIN OR NICKEL PLATED
 INSULATOR: UL 94V-0 RATED BLACK PBT
 +30% FIBER-GLASS OR NYLON-66
 RoHS COMPLIANT
ELECTRICALS:
 CURRENT RATING: 5 AMPS
 CONTACT RESISTANCE: 15 mOHMS MAX
 INSULTOR RESISTANCE: 1000 MOHMS MIN
 VOLTAGE: 500V AC FOR 1 MINUTE
 TEMPERATURE: -50°C TO +100°C

POS.	A	B	C	D	E	F	G
09	1.213	0.984	0.666	0.756	0.329	.109	0.496
	30.80	24.99	16.92	19.20	8.36	2.77	12.60
15	1.543	1.312	0.994	1.091	0.329	.109	0.496
	39.19	33.32	25.25	27.70	8.36	2.77	12.60
25	2.087	1.852	1.534	1.618	0.329	.109	0.496
	53.00	47.04	38.96	41.10	8.36	2.77	12.60
37	2.732	2.500	2.181	2.256	0.329	.109	0.496
	69.30	63.50	55.42	57.30	8.36	2.77	12.60
50	2.838	2.406	2.079	2.169	.436	.109	.602
	67.00	61.00	52.80	55.10	11.07	2.77	15.30

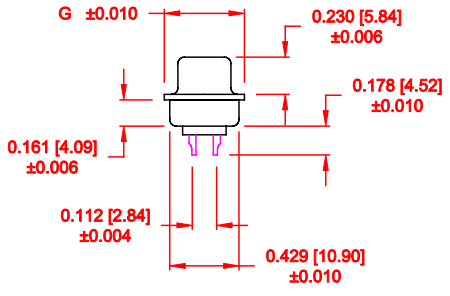
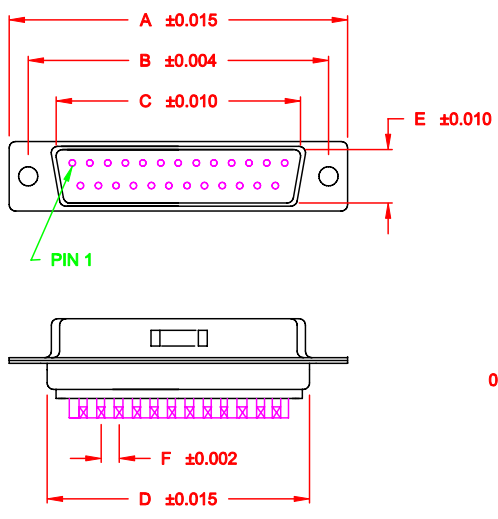

171-YYY-10YLYY1

SERIES
 POSITIONS
 009
 015
 025
 037
 050
 GENDER
 1 = MALE
 2 = FEMALE
 TERMINATION
 0 = SOLDER CUP
 SHELL PLATING
 2 = TIN
 3 = NICKEL
 HARDWARE OPTIONS
 00 = NO HARDWARE
 01 = .098 4-40 CLINCH NUT BOARD SIDE
 02 = .236 4-40 CLINCH NUT BOARD SIDE
 03 = .236 4-40 CLINCH NUT MATING SIDE
 05 = .237 4-40 BOARD LOCK
 91 = .237 4-40 SPACER/BOARD LOCK
 PLATING OPTIONS
 1 = GOLD FLASH
 2 = 30 MICRO-INCH GOLD

WILL ACCEPT 28-20 AWG CONDUCTORS

DO NOT SCALE FROM DRAWING

RoHS COMPLIANT

 THESE DRAWINGS AND SPECIFICATIONS ARE THE PROPERTY OF NorComp AND SHALL NOT BE REPRODUCED, COPIED OR USED AS THE BASIS FOR THE MANUFACTURE OF SALE OF APPARATUS WITHOUT WRITTEN PERMISSION.	DRAWN: PAM JENKINS	DATE: 9-13-05	
	CHECKED:	DATE:	
NorComp	SCALE:	SHEET 1 OF 2	REV 6
	DWG NO. 171-YYY-10YLYY1		

DESCRIPTION: CLINCH NUT HARDWARE

TOLERANCE:
ALL DIMENSIONS ARE ± 0.010

ALL CLINCH-NUTS ARE 4-40 INTERNAL THREADS

01X 0.098" (BOARD SIDE) - CN1

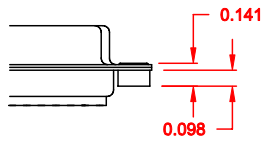

02X 0.236" (BOARD SIDE) - CN2

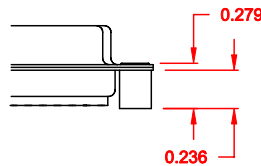

03X 0.236" (MATING SIDE) - CN8

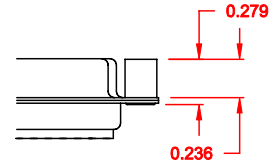

05X 0.237" (BOARD SIDE) - CN10

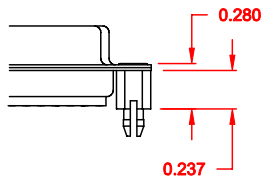

91X 0.237" BOARD SIDE
0.197 MATING SIDE
CN10/SFSO4404

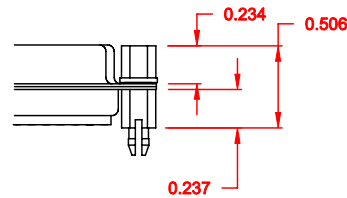

NOTE: 4-40 FEMALE SCREW LOCK IS REMOVABLE

DO NOT SCALE FROM DRAWING

RoHS COMPLIANT

	THESE DRAWINGS AND SPECIFICATIONS ARE THE PROPERTY OF NorComp AND SHALL NOT BE REPRODUCED, COPIED OR USED AS THE BASIS FOR THE MANUFACTURE OF SALE OF APPARATUS WITHOUT WRITTEN PERMISSION.		DRAWN: WAYNE ROBBINS	DATE: 11-28-05
			CHECKED:	DATE:
<h1>NorComp</h1>		SCALE:	SHEET 2 OF 2	REV 6
		DWG NO. 171-YYY-10YLYY1		