

REVISONS		DATE	DWN	APVD
P	LTR	DESCRIPTION		
B		REVISED (ECR-08-024310)	04NOV08	B.W S.C

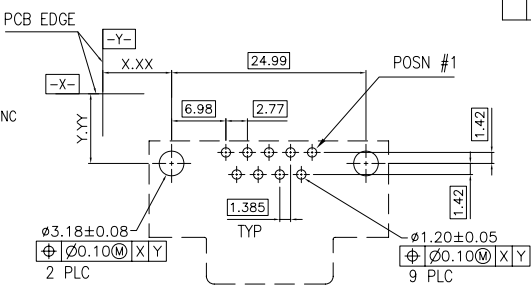

RECOMMENDED PCB LAYOUT
 PCB TOLERANCE ±0.05

- NOTES:
- MATERIAL:
 - HOUSING: THERMOPLASTIC, UL 94V-0 RATED, BLACK
 - CONTACTS: PHOSPHOR BRONZE
 - SHELL: SPCC
 - BOARDLOCKS: BRASS
 - RIVET: COPPER ALLOY
 - FINISH:
 - CONTACT:
 - GOLD PLATING ON CONTACT AREA
 - 2.54um[100u"] MIN. MATTE TIN PLATING ON SOLDER TAIL AREA
 - 1.27um[50u"] MIN. NICKEL UNDERPLATING OVERALL
 - BOARDLOCK:
 - 2.54um[100u"] MIN. MATTE TIN PLATING
 - 1.27um[50u"] MIN. NICKEL UNDERPLATING OVERALL
 - SHELL: NICKEL PLATED
 - RIVET: NICKEL PLATING OVERALL
 - RECOMMENDED PCB THICKNESS: 1.6 mm
 - WAVE SOLDER CAPABLE TO 265°C PER TE SPEC. 109-202, CONDITION B.
 - THE SCREW TORQUE FORCE APPLIED: 7.0 Kgf-cm MAX.
 - NET WEIGHT: 7.03 gram/pc OR 11.0 gram/pc(WITH SCREW)

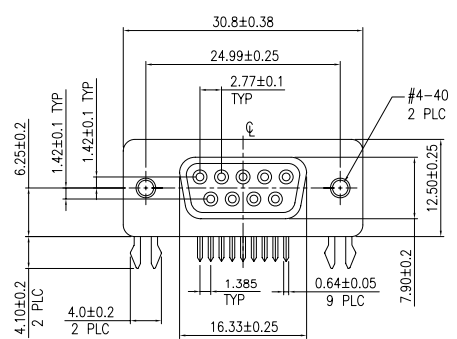
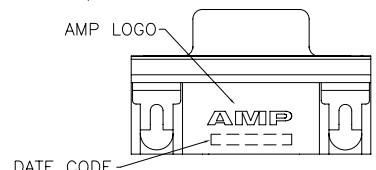
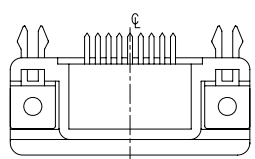
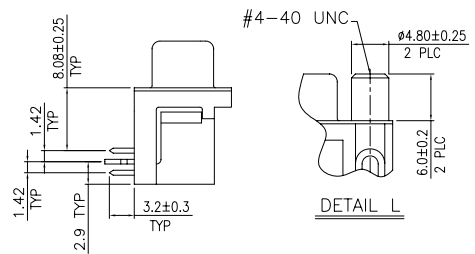
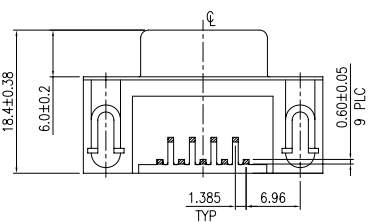

OBSOLETE	W/	15u"	1-1734348-2
	W/O	15u"	1734348-2
		G/F	1734348-1
SCREW	GOLD PLATING	AMP PART NO.	

THIS DRAWING IS A CONTROLLED DOCUMENT.		DWN J. LEE 11JUL2007	Tyco Electronics Corporation Taipei, Taiwan	
DIMENSIONS: MM		CHK S. HOU 11JUL2007	NAME RECEPTACLE ASSEMBLY, 9 POSN, RIGHT ANGLE, 8.08mm[0.318in] SERIES, AMPLIMITE	
TOLERANCES UNLESS OTHERWISE SPECIFIED:		APVD W. J. KE 11JUL2007	PRODUCT SPEC 108-57541	
0 PLC ± -		QUALIFICATION TEST REPORT 501-57613		
1 PLC ± 0.38		WEIGHT SEE NOTES	SIZE A3	CAGE CODE 00779
2 PLC ± 0.25		DRAWING NO 1734348		
3 PLC ± 0.15		RESTRICTED TO		
4 PLC ± -		SCALE		
ANGLES ± -		SHEET 1 of 2		
MATERIAL SEE NOTE		REV B		
FINISH SEE NOTE		CUSTOMER DRAWING		

4

3

2

1

THIS DRAWING IS UNPUBLISHED. RELEASED FOR PUBLICATION
 © COPYRIGHT BY TYCO ELECTRONICS CORPORATION. ALL RIGHTS RESERVED.

LOC	DIST	REVISIONS			
P	LTR	DESCRIPTION	DATE	DWN	APVD
		SEE SHEET 1.			

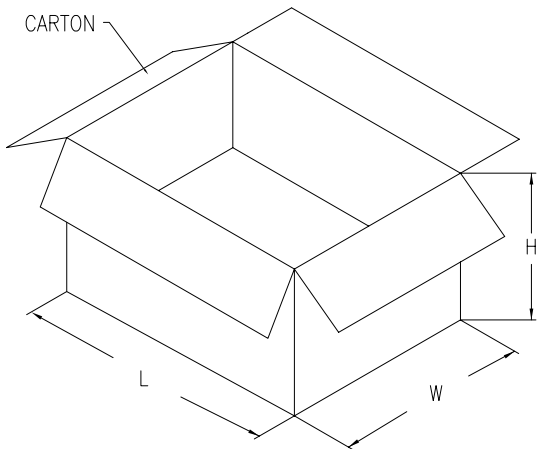
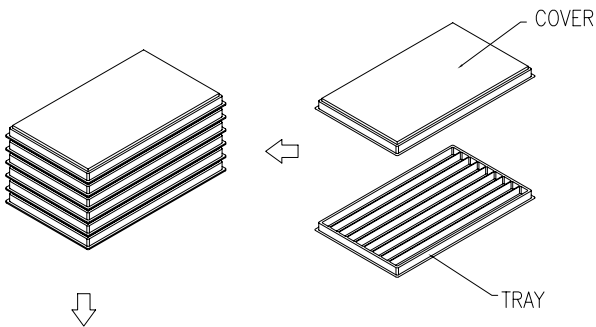

- NOTES:
- MATERIAL:
 - 1.1 TRAY: PVC
 - 1.2 SHIPPING CARTON: CORRUGATED FIBERBOARD
 - DIMENSION:
 - 2.1 TRAY: L=340, W=228, H=15
 - 2.2 SHIPPING CARTON: L=440, W=321, H=153
 - QUANTITY:
 - 3.1 PRIMARY PACKING: 90 PCS/TRAY
 - 3.2 SECONDARY PACKING: 11 TRAY/CARTON (990PCS)
 - SHIPPING CARTON WEIGHT:
 - 4.1 NET WEIGHT: 6.962 Kg OR 10.8 Kg(WITH SCREWS)
 - 4.2 GROSS WEIGHT: 7.962 Kg OR 11.8 Kg(WITH SCREWS)

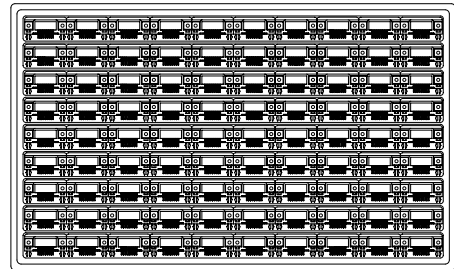

THIS DRAWING IS A CONTROLLED DOCUMENT.		DWN	Tyco Electronics Corporation Taipei, Taiwan	
DIMENSIONS: MM		CHK	NAME	
TOLERANCES UNLESS OTHERWISE SPECIFIED: 0 PLC ± 1 PLC ± 2 PLC ± 3 PLC ± 4 PLC ± ANGLES ±		APVD	RECEPTACLE ASSEMBLY, 9 POSN, RIGHT ANGLE, 8.08mm[0.318in] SERIES, AMPLIMITE	
MATERIAL		FINISH	PRODUCT SPEC	APPLICATION SPEC
			SIZE	CAGE CODE
			A3	00779
			DRAWING NO	RESTRICTED TO
			C=1734348	
			CUSTOMER DRAWING	SCALE
				SHEET 2 of 2
				REV B