

REVOLUTIONS		DATE	BY	APP
GP	00			
O		RELEASED PER EC 0513-0288-05	28SEP06	GP JG

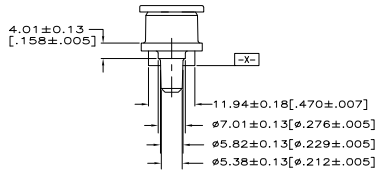

- △ MATERIAL: HOUSING - FLAME RETARDANT POLYESTER, BLACK, 94VO RATED. TERMINALS - GOLD OVER NICKEL PLATED COPPER ALLOY. RETAINER - POLYETHYLENE, NATURAL. SHIELD - NICKEL PLATED ZINC CASTING.
- △ TUBE PLUG, PART NUMBER 555265-1.
- 3. THE CONTACT SURFACES OF THE TERMINALS ARE COATED WITH LUBRICANT.
- △ RETAINER SHALL BE REMOVED AND DISCARDED ONLY AFTER CONNECTOR AND TERMINALS ARE RETAINED BY PRINTED CIRCUIT BOARD.
- △ MAXIMUM EXTRACTION FORCE OF TERMINAL 12 LBS.
- 6. GOLD PLATING THICKNESS AT THE POINT OF MEASUREMENT SHALL AVERAGE .698 μm - .828 μm [.0000275 - .0000325] FOR TERMINALS.
- 7. 10 EMI RECEPTACLE ASSEMBLIES PACKAGED PER TUBE.
- △ 5554857-1 IS ONE ASSEMBLY PACKAGED IN A TUBE.
- △ LABEL INDICATES PIN ONE (1) END OF ALL ASSEMBLIES IN A TUBE.
- △ THREADS SHALL BE FUNCTIONAL AFTER PLATING.
- △ ALL DIMENSIONS SHOWN IN FIGURE D ARE NOMINAL AND ASSEMBLIES WILL SLIDE FREELY WITH TUBE AT 45° INCLINE.

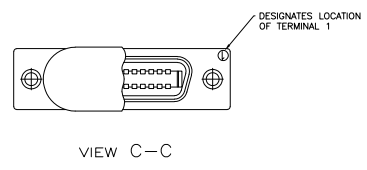
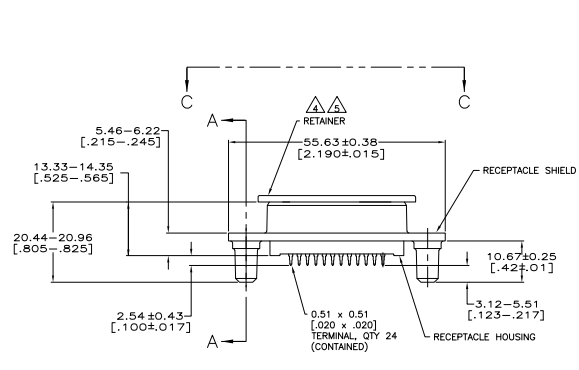
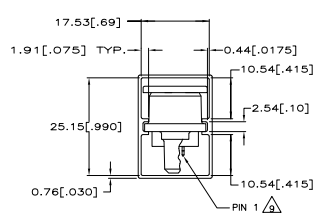
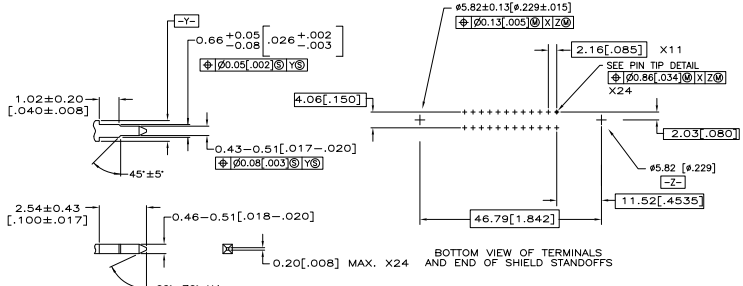
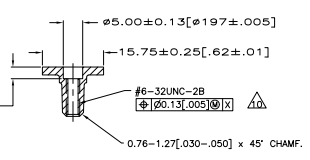
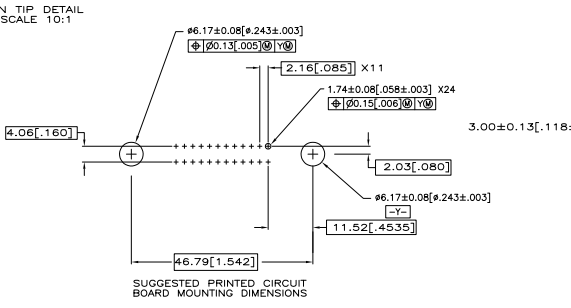
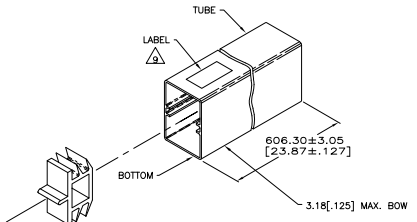

FIGURE D



THIS DRAWING IS A CONTROLLED DOCUMENT.		APPROVED BY	DATE	5554857-1
DRAWING NO.		DESIGNED BY	DATE	PACKAGING PART NUMBER
REVISIONS		DATE	BY	APP
1		00779	C	5554857
CUSTOMER DRAWING		DATE	BY	APP
		DATE	BY	APP