

BWA SERIES RF CO-AXIAL CONNECTORS

The BWA series are converter adapters used for connecting connectors of different series.

- (1) Has mating portions compatible in materials and finish with the respective series.
- (2) Conforms in performance to the lower series of the two connectors to be connected.

Converter adapter list

Mating portion 1		Mating portion 2		Part No.	CL No.	Remarks	Shape		
Series name	Mating portion	Series name	Mating portion						
N	P	BNC	P	NP-BNCP(40)	311-0050-7-40		Fig.1		
			J	JUG-201A/U(40)	311-0007-8-40		Fig.2		
		M	J	NP-MJ(40)	311-0019-7-40		Fig.3		
			J	N.P-S.J(40)	311-0245-6-40		Fig.4		
		HRM	P	HRM-555S(40)	311-0125-4-40		Fig.5		
			J	HRM-554S(40)	311-0123-9-40		Fig.6		
	J	BNC	P	UG-349/U(40)	311-0004-0-40		Fig.7		
			J	NJ-BNCJ(40)	311-0005-2-40		Fig.8		
				NJ-BNCJ-PA(40)	311-0014-3-40	Panel-mount type	Fig.9		
		M	P	NJ-MP(40)	311-0018-4-40		Fig.10		
			J	NJ-MJ(40)	311-0011-5-40		Fig.11		
		TNC	P	N.J-TNC.P(40)	311-0225-9-40		Fig.12		
		HRM	P	HRM-553S	311-0121-3		Fig.13		
			J	HRM-552S	311-0119-1		Fig.15		
		BNC	P	M	P	BNCP-MP(40)	311-0062-6-40		Fig.17
					J	BNCP-MJ(40)	311-0008-0-40		Fig.18
S	P			SP-BNCP(40)	311-0055-0-40		Fig.19		
	J			SJ-BNCP(40)	311-0060-0-40		Fig.20		
UM	J			BNCP-UMJ(40)	311-0065-4-40		Fig.21		
MSS	P			BNCP-MSSP(40)	311-0107-2-40		Fig.22		
	J			BNCP-MSSJ(40)	311-0082-3-40		Fig.23		
HRM	P			HRM-519(40)	311-0101-6-40		Fig.24		
	J		HRM-518(40)	311-0100-3-40		Fig.25			
J	UHF		P	UG-273/U(40)	311-0003-7-40		Fig.26		
	M		P	BNCJ-MP(40)	311-0009-3-40		Fig.27		
			J	MJ-BNCJ(40)	311-0020-6-40		Fig.28		
	S		P	SP-BNCJ(40)	311-0058-9-40		Fig.29		
				SJ-BNCJ(40)	311-0054-8-40		Fig.30		
			J	SJ-BNCJ-PA(40)	311-0108-5-40	Panel-mount type	Fig.31		
	TNC		J	BNC.J-TNC.J(40)	311-0194-7-40		Fig.32		
	UM		P	BNCJ-UMP(40)	311-0052-2-40		Fig.33		
			J	BNCJ-UMJ(40)	311-0053-5-40		Fig.34		
	BNCJ-UMJ-PA(40)			311-0103-1-40	Panel-mount type	Fig.35			
	MSS		P	BNCJ-MSSP(40)	311-0081-0-40		Fig.36		
		J	BNCJ-MSSJ(40)	311-0066-7-40		Fig.37			

BWA SERIES RF CO-AXIAL CONNECTORS

Mating portion 1		Mating portion 2		Part No.	CL No.	Remarks	Shape
Series name	Mating portion	Series name	Mating portion				
BNC	J	HRM	P	HRM-517(40)	311-0099-6-40		Fig.38
			J	HRM-516(40)	311-0102-9-40		Fig.39
		POD	P	BNCJ-PODP(40)	311-0160-5-40		Fig.40
			J	BNCJ-PODJ(40)	311-0161-8-40		Fig.41
			PO6	BNCJ-PO6J(40)	311-0167-4-40		Fig.42
S	P	HRM	P	HRM-509(40)	311-0093-0-40		Fig.43
			J	HRM-508(40)	311-0092-7-40		Fig.44
	J	HRM	P	HRM-507(40)	311-0091-4-40		Fig.45
				HRM-512(40)	311-0098-3-40	Panel-mount type	Fig.46
				HRM-512S(40)	311-0144-9-40	Panel-mount type, S type	Fig.46
			J	HRM-506(40)	311-0090-1-40		Fig.47
				HRM-511(40)	311-0094-2-40	Panel-mount type	Fig.48
				HRM-511S(40)	311-0143-6-40	Panel-mount type, S type	Fig.48
TNC	J	HRM	J	HRMJ-TNCJ-PA(40)	311-0202-3-40	Panel-mount type	Fig.49
UM	P	HRM	J	UM.P-HRM.J(40)	311-0176-5-40		Fig.50
	J	HRM	J	HRMJ-UMJ(40)	311-0164-6-40		Fig.51
HRM	P	POB	P	HRMP-POBP-1(40)	311-0169-0-40		Fig.52
			J	HRMP-POBJ	311-0152-7		Fig.53
		POD	J	HRM.P-POD.J(40)	311-0177-8-40		Fig.54
		POD1	J	HRMP-POD1J(40)	311-0253-4-40		Fig.55
		PO6	J	HRMP-PO6J(40)	311-0172-4-40		Fig.56
		S,FL	J	HRMP-S.FLJ-2(40)	311-0249-7-40	For inspecting harnesses parts	Fig.57
		H,FL	J	HRMP-H.FLJ(40)	311-0232-4-40	For inspecting harnesses parts	Fig.58
		HRMM	P	HRMP-HRMMP(40)	311-0250-6-40		Fig.59
				J	HRMP-HRMMJ	311-0243-0	
			J	HRMP-HRMMJ-LA(40)	311-0226-1-40		Fig.61
				HRMJ-POBP(40)	311-0151-4-40		Fig.62
		J	POB	P	HRMJ-POBP-PA(40)	311-0206-4-40	
	J				HRMJ-POBJ(40)	311-0149-2-40	
	J			HRMJ-POBJ-PA(40)	311-0150-1-40		Fig.65
				POD	P	HRMJ-PODP(40)	311-0157-0-40
	POD1		P	HRMJ-POD1P-1(40)	311-0254-7-40		Fig.67
	PO6		P	HRMJ-PO6P(40)	311-0173-7-40		Fig.68
	PO51		P	HRMJ-PO51P(40)	311-0231-1-40		Fig.69
	FL		P	HRMJ-FLP-1(40)	311-0195-0-40		Fig.70
			J	HRMJ-FLJ(40)	311-0179-3-40		Fig.71
	S,FL		P	HRMJ-S.FLP(40)	311-0218-3-40		Fig.72
	H,FL		P	HRMJ-H.FLP-3(40)	311-0264-0-40		Fig.73
	HRMM		P	HRMJ-HRMMP-2	311-0221-8		Fig.74
				HRMJ-HRMMP-LA(40)	311-0227-4-40		Fig.75
				J	HRMJ-HRMMJ	311-0220-5	

- Note 1. Part No. NP-BNCP of Fig.1 is shown that series name N, coupling part p (plug) for connecting part 1 and series name BNC, coupling part P (plug) for connecting part 2.
 2. Series name of each connecting parts are shown in order to HIROSE's CL numbers.

BWA SERIES RF CO-AXIAL CONNECTORS

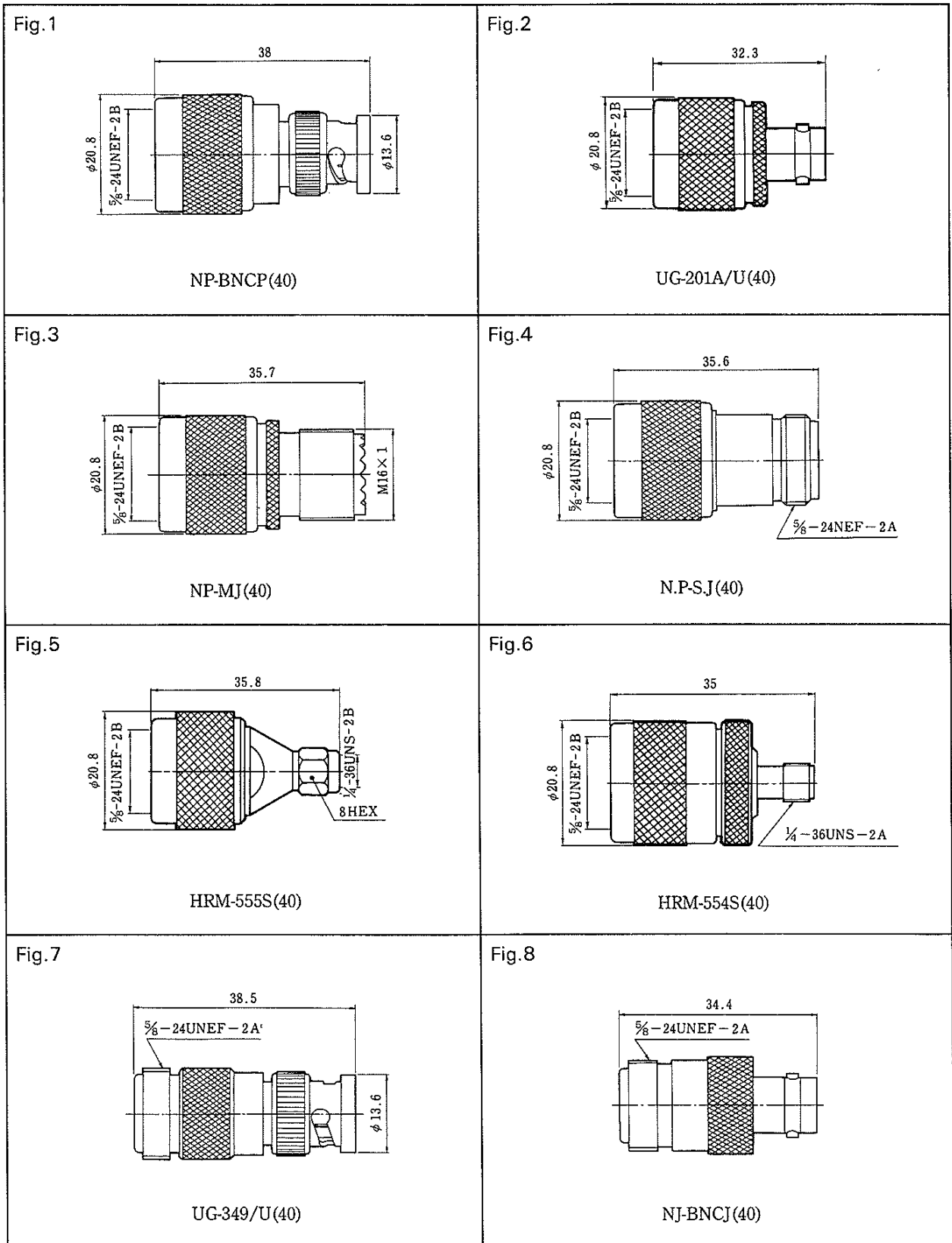

BWA SERIES RF CO-AXIAL CONNECTORS

Fig.9

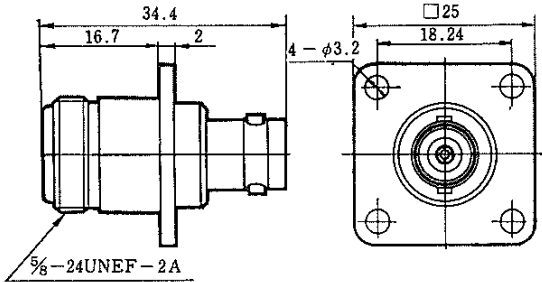

NJ-BNCJ-PA(40)

Fig.10

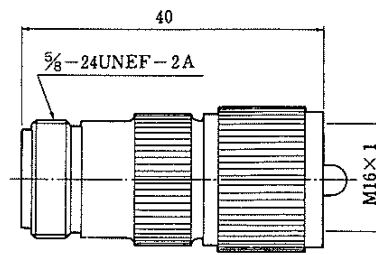

NJ-MP(40)

Fig.11

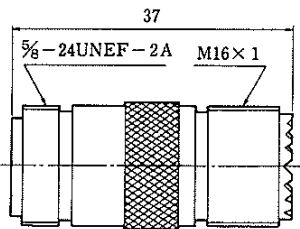

NJ-MJ(40)

Fig.12

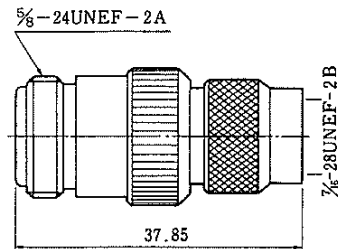

NJ-TNC.P(40)

Fig.13

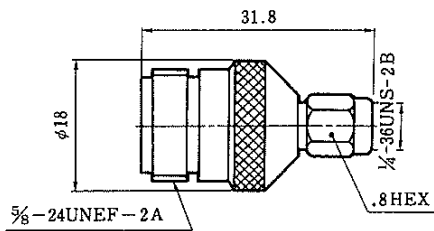

HRM-553S

Fig.15

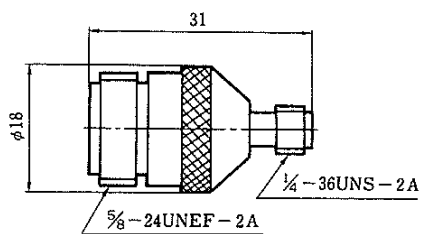

HRM-552S

BWA SERIES RF CO-AXIAL CONNECTORS

Fig.17

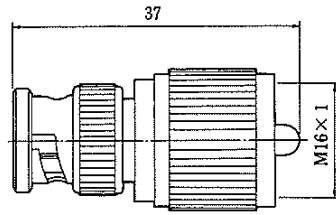

BNC-MP(40)

Fig.18

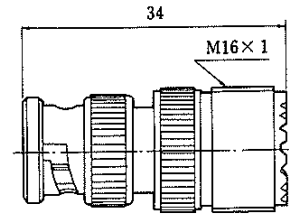

BNC-MJ(40)

Fig.19

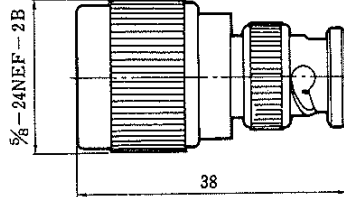

SP-BNC(40)

Fig.20

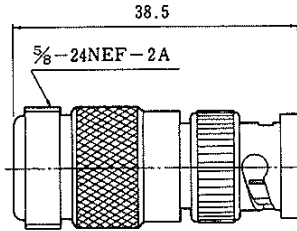

SJ-BNC(40)

Fig.21

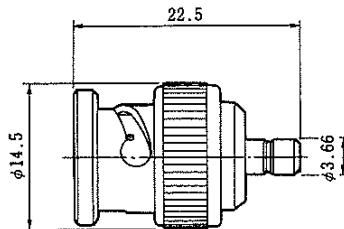

BNC-UMJ(40)

Fig.22

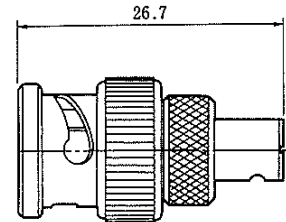

BNC-MSSP(40)

Fig.23

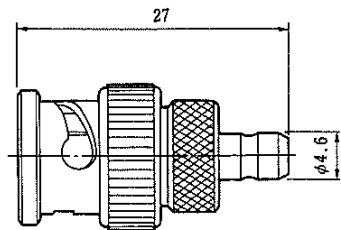

BNC-MSSJ(40)

Fig.24

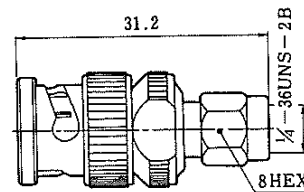

HRM-519(40)

BWA SERIES RF CO-AXIAL CONNECTORS

Fig.25

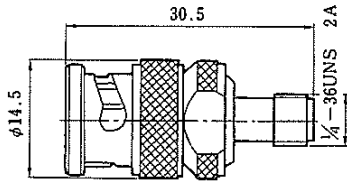

HRM-518(40)

Fig.26

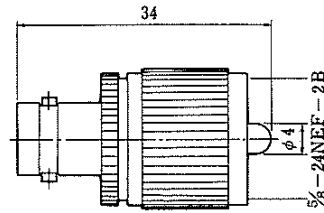

UG-273/U(40)

Fig.27

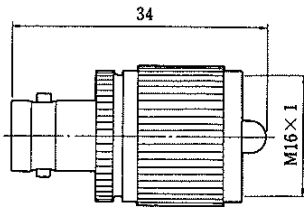

BNCJ-MP(40)

Fig.28

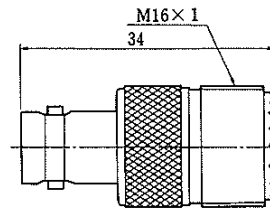

MJ-BNCJ(40)

Fig.29

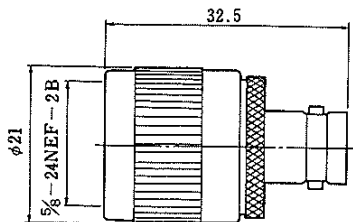

SP-BNCJ(40)

Fig.30

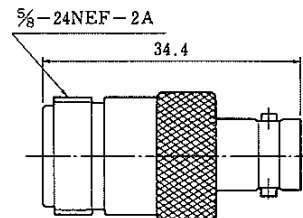

SJ-BNCJ(40)

Fig.31

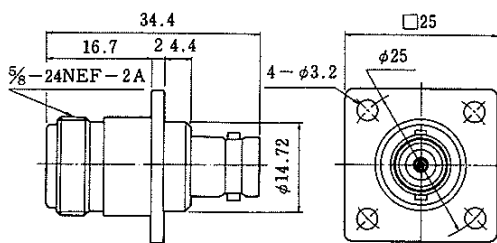

SJ-BNCJ-PA(40)

Fig.32

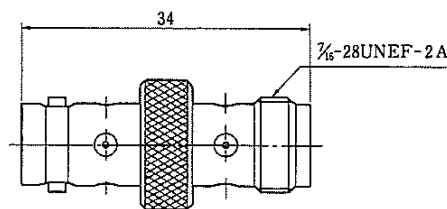

BNCJ-TNCJ(40)

BWA SERIES RF CO-AXIAL CONNECTORS

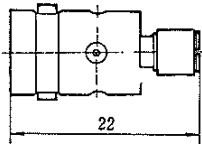
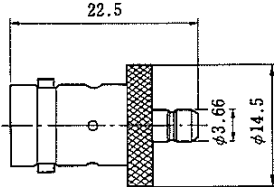
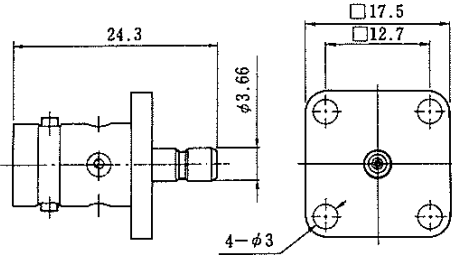
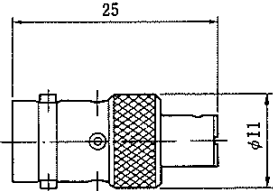
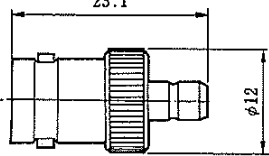
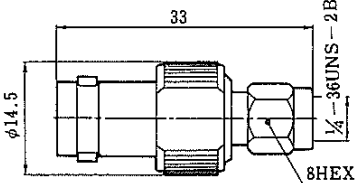
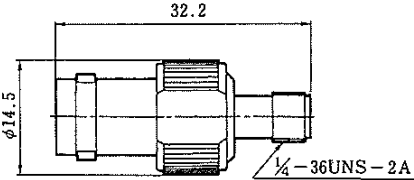
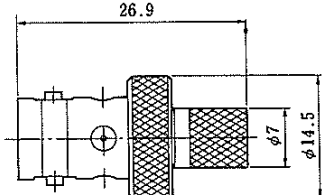
<p>Fig.33</p>  <p>BNCJ-UMP(40)</p>	<p>Fig.34</p>  <p>BNCJ-UMJ(40)</p>
<p>Fig.35</p>  <p>BNCJ-UMJ-PA(40)</p>	<p>Fig.36</p>  <p>BNCJ-MSSP(40)</p>
<p>Fig.37</p>  <p>BNCJ-MSSJ(40)</p>	<p>Fig.38</p>  <p>HRM-517(40)</p>
<p>Fig.39</p>  <p>HRM-516(40)</p>	<p>Fig.40</p>  <p>BNCJ-PODP(40)</p>

BWA SERIES RF CO-AXIAL CONNECTORS

Fig.41

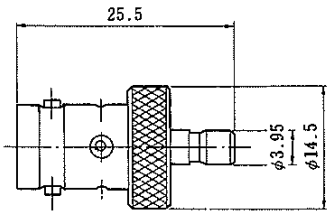

BNCJ-PODJ(40)

Fig.42

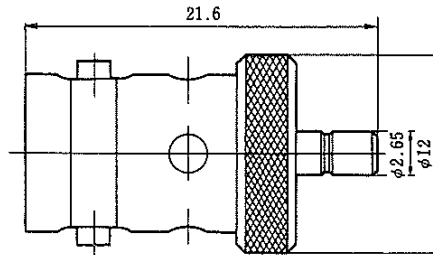

BNCJ-PO6J(40)

Fig.43

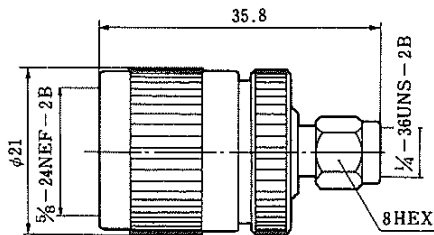

HRM-509(40)

Fig.44

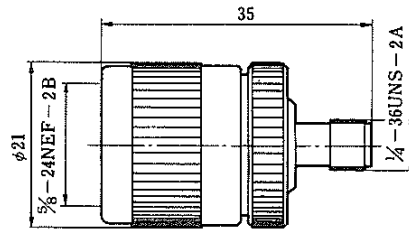

HRM-508(40)

Fig.45

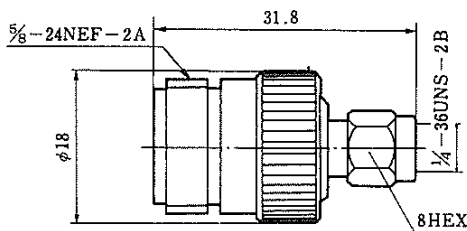

HRM-507(40)

Fig.46

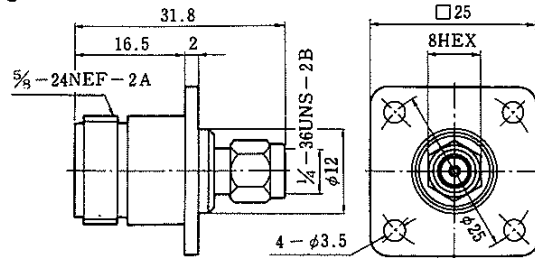

HRM-512(40) HRM-512S(40)

Fig.47

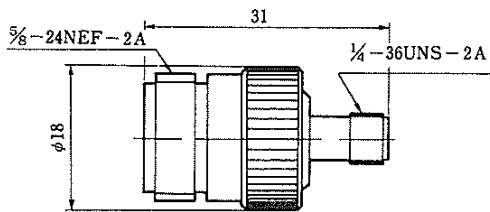

HRM-506(40)

Fig.48

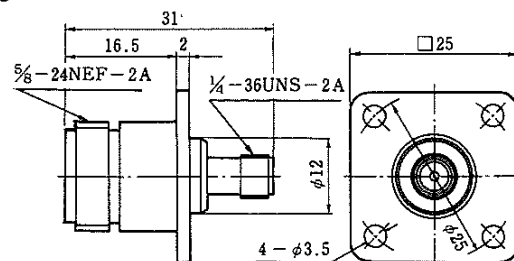

HRM-511(40) HRM-511S(40)

BWA SERIES RF CO-AXIAL CONNECTORS

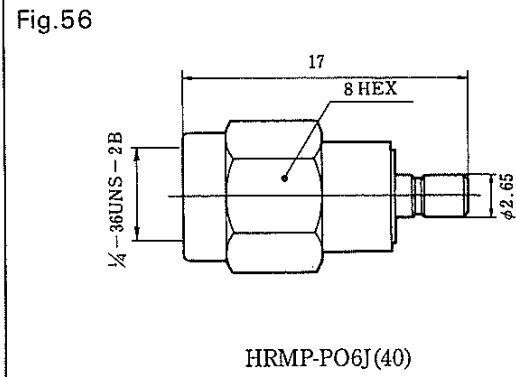
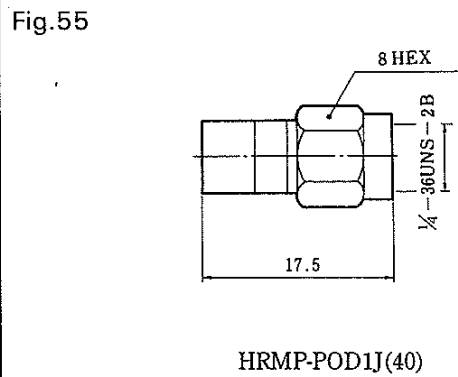
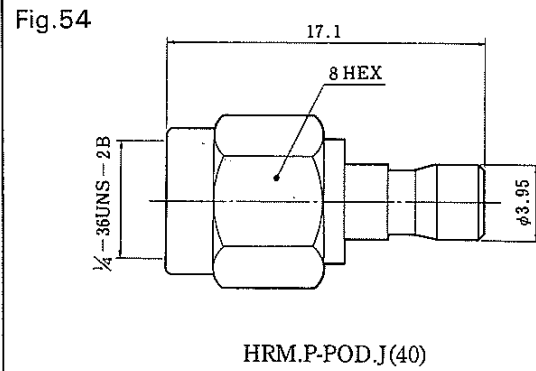
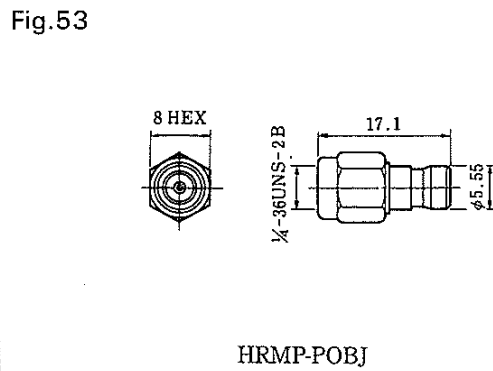
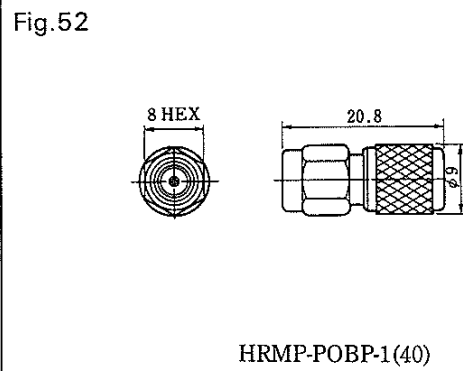
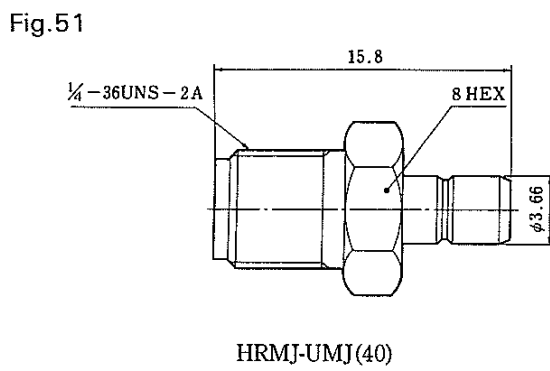
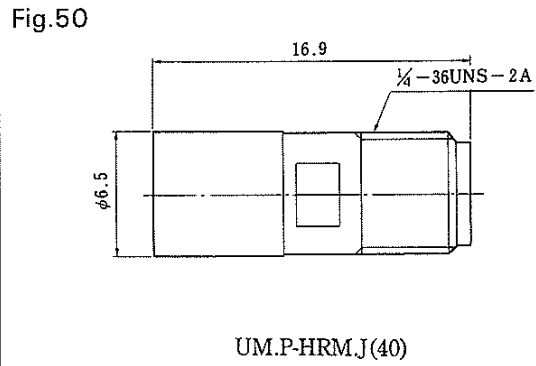
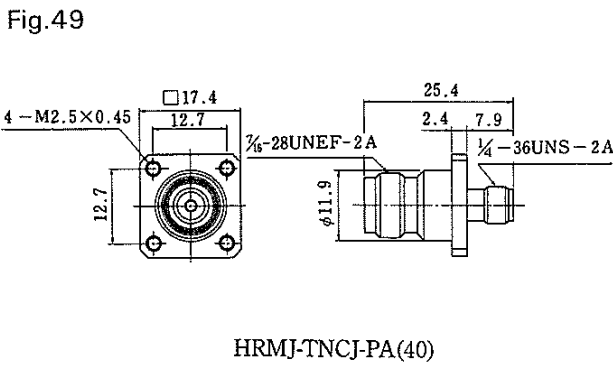

BWA SERIES RF CO-AXIAL CONNECTORS

Fig.57

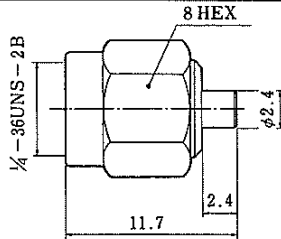

Note : The mating portion on the S. FL side mates with the S. FL and S. FL2 plugs. Having no locking mechanism, however, the S. FL side mating portion can be used only for performance measurement.

HRMP-S.FLJ-2(40)

Fig.58

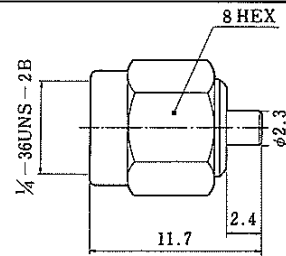

Note : Having no locking mechanism, however, the S. FL side mating portion can be used only for performance measurement.

HRMP-H.FLJ(40)

Fig.59

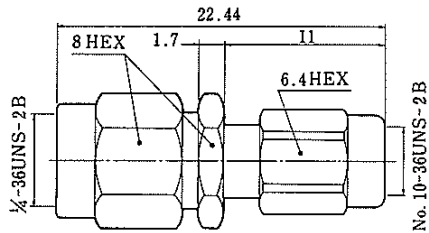

HRMP-HRMMP(40)

Fig.60

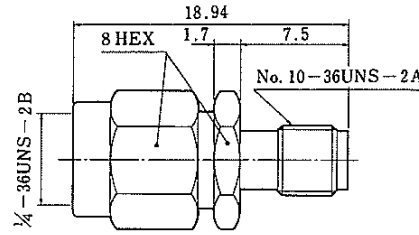

HRMP-HRMMJ

Fig.61

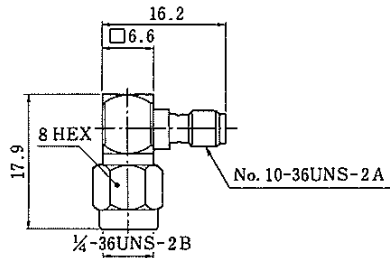

HRMP-HRMMJ-LA(40)

Fig.62

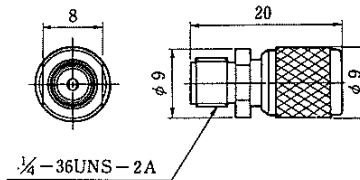

HRMJ-POBP(40)

Fig.63

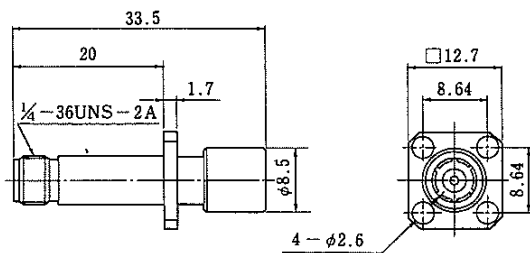

HRMJ-POBP-PA(40)

Fig.64

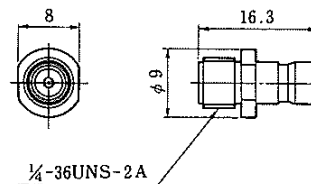

HRMJ-POBJ(40)

BWA SERIES RF CO-AXIAL CONNECTORS

Fig.65

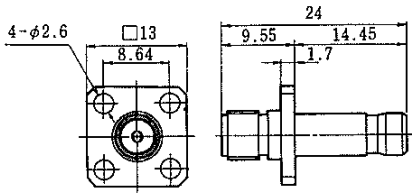

HRMJ-POBJ-PA(40)

Fig.66

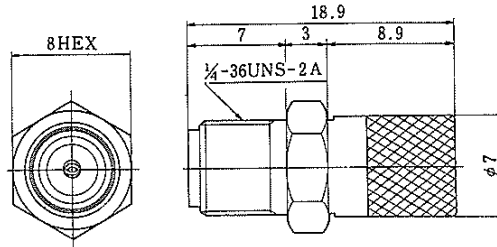

HRMJ-PODP(40)

Fig.67

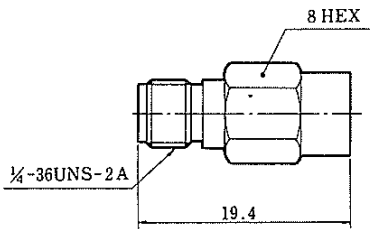

HRMJ-POD1P-1(40)

Fig.68

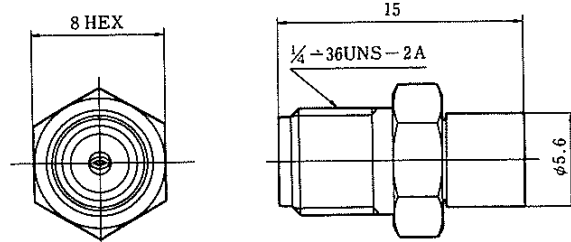

HRMJ-PO6P(40)

Fig.69

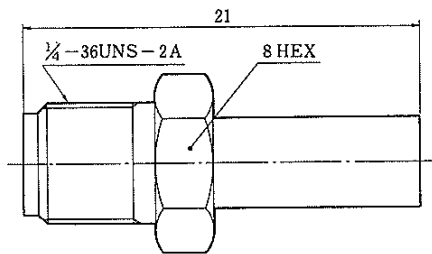

HRMJ-PO51P(40)

Fig.70

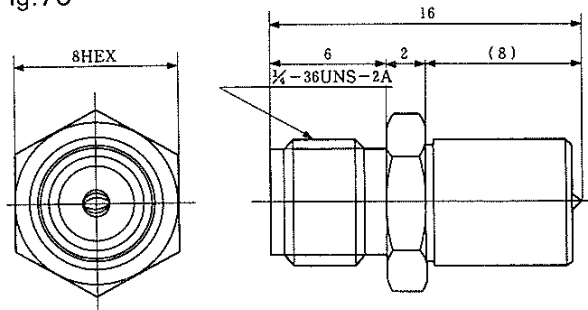

HRMJ-FLP-1(40)

Fig.71

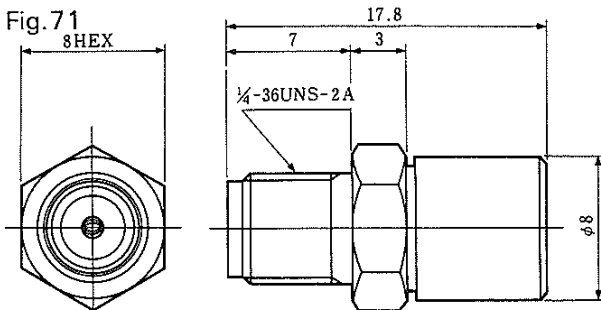

HRMJ-FLJ(40)

Note : Having no locking mechanism, however, the FL side mating portion can be used only for performance measurement.

Fig.72

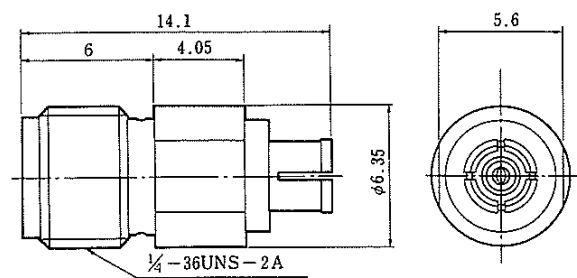

HRMJ-S.FLP(40)

Note : Compatible with S. FL and S. FL2.

BWA SERIES RF CO-AXIAL CONNECTORS

