

Push-On Coaxial Connectors (PC Card Type II Mountable)

MRF01 Series

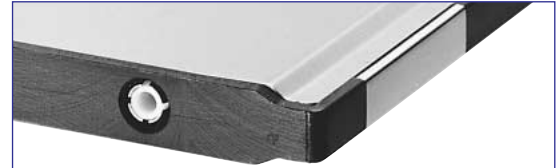

Modem Card Mounting Example
(A special frame kit has not been manufactured.)

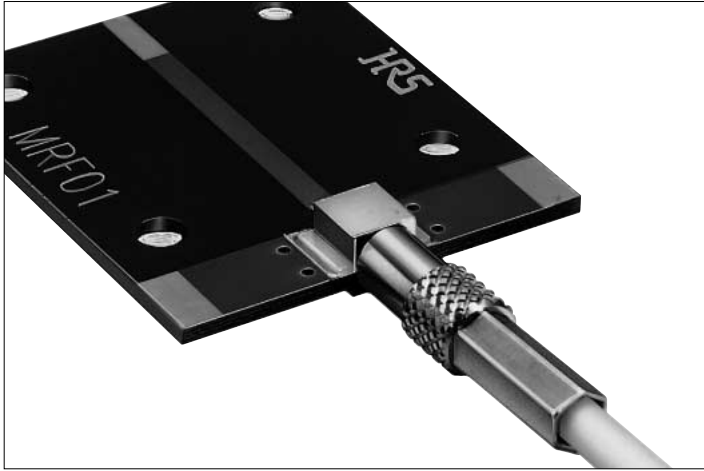

Board Mounting Example

■ Features

1. Uses a push-on type system which is easy to engage and disengage. (There is no lock.)
2. Mountable on PCMCIA Type II Card

The 3 mm receptacle thickness permits mounting to the back side of a type II card.

Note that at the time of card mounting, use of 0.15mm offset of the board mounting surface from the card center line will result in the same card center axis and connector center axis.

3. High Degree of Matching

These connectors offer high frequency performance from 0 to 3 GHz with a V.S.W.R. of 1.3 or less.

4. Accommodates Ultra-Fine Cable

Suitable cable ...RG-178B/U ($\phi 1.8$)

...RG-196A/U ($\phi 2$)

■ Applications

Wireless LAN cards, GPS cards, and miniature wireless communications devices.

■ Function Diagrams

| Jack Side | |
|--|--|
| ■ Jack MRF01-J-178 | |
| ■ Receptacle MRF 01-R-1 | |
| ■ Conversion Adapter (Coupling portion: MRF01 side jack - SMA side jack) MRF01J-HRMJ | |

| Plug Side | |
|--|--|
| ■ Plug Receptacle MRF01-PR-1 | |
| ■ Conversion Adapter (Coupling portion: MRF01 side plug - SMA side jack) MRF01P-HRMJ | |

Product Specifications

| | | | | |
|---------|----------------------------------|-------------|---|-------------------------------|
| Ratings | Nominal characteristic impedance | 50 ohms | Operating temperature Operating humidity | -20°C to +60°C 95% or less |
| | Voltage | 150 V AC | | |
| | Rated Frequency | DC to 3 GHz | | |

| Item | Requirements | Test Conditions |
|--|---|--|
| 1. Contact resistance | Inner : 10 mΩ max. Outer : 3 mΩ max. | 10 mA max. |
| 2. Insulation resistance | 5000 MΩ min. | 500 V DC |
| 3. Withstanding voltage | No flashover or insulation breakdown. | 500 V AC / 1 minute |
| 4. V.S.W.R.(*) | 1.3 N max. | DC to 3 GHz |
| 5. Female contact retention | 0.137 N min. | Measured with a ϕ 0.381 pin gauge |
| 6. Insertion and withdrawal force (plug) | 0.56 N min. | With corresponding connector |
| 7. Durability (Insertion/withdrawal) | Contact resistance: Amount of change 20 mΩ max. | 10,000 cycles |
| 8. Vibration | No electrical discontinuity of 1μs or more No damage, cracks, or parts looseness. | Frequency: 10 to 2000 Hz, single amplitude of 0.76 mm or acceleration of 147 m/s ² (peak), 4 hours in each of the 3 directions. |
| 9. Shock | No electrical discontinuity of 1μs or more No damage, cracks, or parts looseness. | Acceleration of 490 m/s ² , 11 ms duration, sine half-wave waveform, 6 cycles in each of the 3 axis |
| 10. Humidity (Steady state) | Insulation resistance: 100 MΩ min. Contact resistance: Amount of change 20 mΩ max. No damage, cracks, or parts looseness. | 240 hours at temperature of -10°C to 65°C and humidity of 90% to 96% |
| 11. Temperature cycle | No damage, cracks, or parts looseness. | Temperature: -65°C → 20 to 35°C → 125°C → 20 to 35°C Time: 30 min → Within 5 min → 30 min. → Within 5 min Cycles: 5 |
| 12. Hydrogen sulfide gas | Contact resistance: Amount of change 20 mΩ max. No damage, cracks, or parts looseness. | Leave for 96 hours in an atmosphere of 3ppm concentration sulfur dioxide gas at temperature of 40°C and humidity of 80%. |
| 13. Salt spray | No marked corrosion | Exposed to density 5% salt water for 48 hours |

*Voltage standing wave ratio (V.S.W.R.) measuring system.

The above voltage standing wave ratio (V.S.W.R.) standard value is measured in the measuring system as shown below.

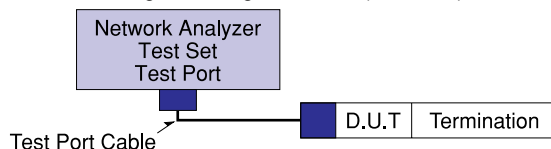

Note1: The cable connector is measured with double ended 10cm cable assembly.

Note2: The printed circuit board connector is mounted on the 50 ohms PCB, to which Hirose's adaptor is connected.

Materials

| Part | Material | Finish |
|----------------------|------------------------|----------------|
| Body | Beryllium copper/Brass | Gold plating |
| Insulator | PTFE | — |
| Female inner contact | Beryllium copper | Gold plating |
| Male inner contact | Phosphor bronze | Gold plating |
| Crimp sleeve | Copper | Nickel plating |

Ordering Information

MRF01 - [] - []

① ② ③

| | |
|---|---|
| ① Series name : MRF01 | ③ Applicable cable or suffix 178: RG-178B/U (ϕ 1.8) RG-196B/U (ϕ 2) |
| ② Connector types J : Jack R : Receptacle PR : Plug receptacle | |

■ Jack

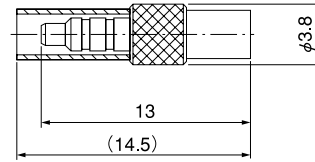

| CL No. | Part Number |
|------------|-------------|
| 313-1102-7 | MRF01-J-178 |

■ Receptacle

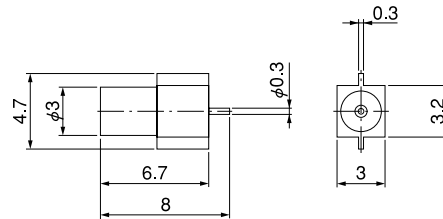
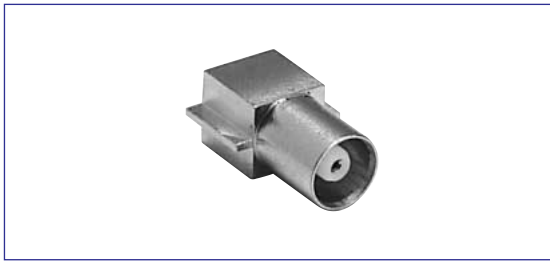

| CL No. | Part Number |
|------------|-------------|
| 313-1101-4 | MRF01-R-1 |

■ Plug Receptacle

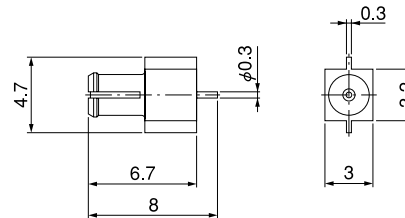

| CL No. | Part Number |
|------------|-------------|
| 313-1100-1 | MRF01-PR-1 |

■ Conversion Adapter

- SMA conversion adapter
(Coupling portion: MRF01 side plug - SMA side jack)

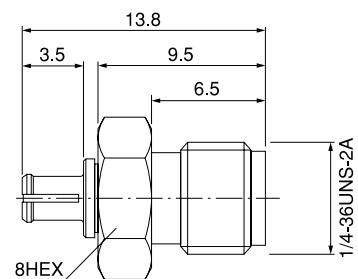

| CL No. | Part Number |
|------------|-------------|
| 311-0289-1 | MRF01P-HRMJ |

- SMA conversion adapter
(Coupling portion: MRF01 side jack - SMA side jack)

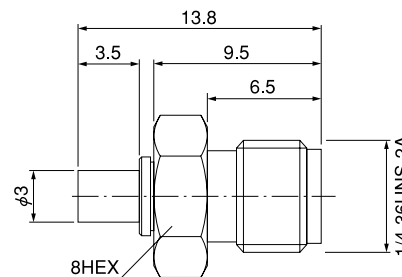

| CL No. | Part Number |
|------------|-------------|
| 311-0290-0 | MRF01J-HRMJ |

■ Connector Mounting Condition

The mounting reference diagram is an anticipated diagram of the condition of mounting to a frame offset 0.15 mm from the card center line.

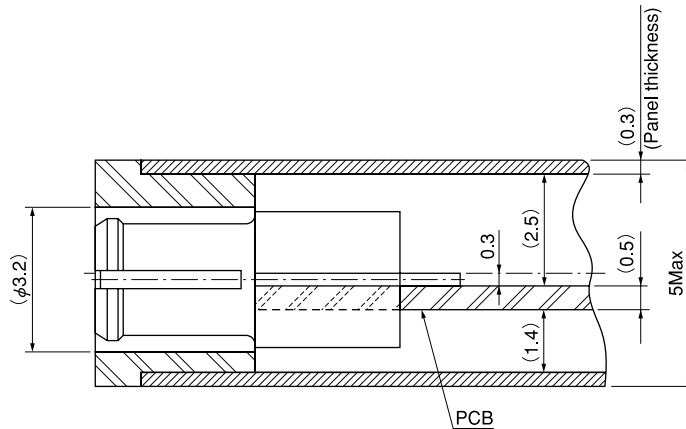

■ PCB mounting pattern

