

**Model 72958  
SMA PLUG R/A CRIMP, RG58**

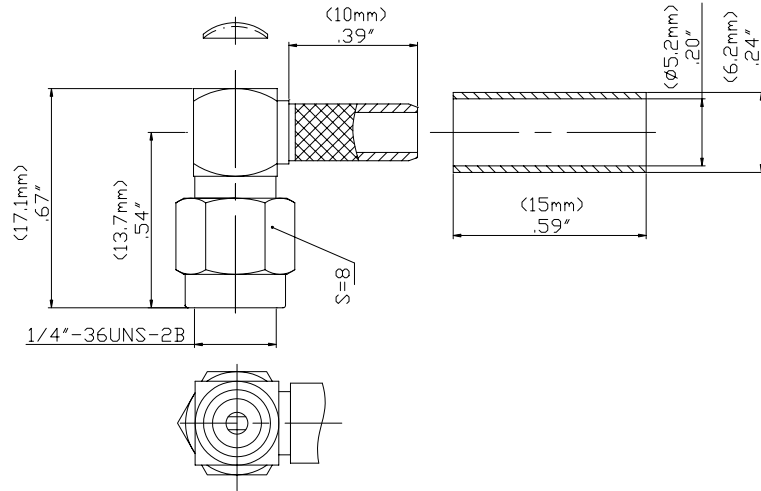

Model 72958 SMA PLUG R/A CRIMP, RG58

High bandwidth, small size, and durability for confident connections.

**Features**

- DC – 12.4 GHz.
- Meets MIL-C-39012, IEC 169-15, CECC 22110.
- Small size and durability for mobile communications.
- Precision machined and gold-plated for low loss.

**Materials**

- Body is machined brass with gold plating.
- Center Contacts - Plug is gold plated brass and Jack is gold plated Beryllium copper.
- Insulators are high quality PTFE.
- Crimp Ferrules are copper with gold or nickel plating.
- Gaskets are silicone rubber.

**Specifications**

Impedance	50 Ω
Frequency Range	0-12.4 GHz on flexible cable
Working Voltage	< 500 Vpeak
Dielectric Withstanding Voltage	1,000 Vrms
VSWR	1.35 max.
Center/Outer Contact Resistance	0.003/0.002 Ω max
Insulation resistance	> 5000 MΩ
Number of Insertions	500 cycles minimum
Temperature Range	-65° C to 165° C, -85° F to 329° F

**Ordering Information**

Model: 72958  
Description: SMA PLUG R/A CRIMP, RG58

USA: Sales: 800-490-2361  
Technical Support: [technicalsupport@pomonatest.com](mailto:technicalsupport@pomonatest.com)  
Fax: 425-446-5844

Europe: 31-(0) 40 2675 150 International: 425-446-5500

Where to Buy: [www.pomonaelectronics.com](http://www.pomonaelectronics.com)

All dimensions are in inches. Tolerances (except noted): .xx = ±.02" (.51 mm), .xxx = ±.005" (.127 mm). All specifications are to the latest revisions. Specifications are subject to change without notice. Registered trademarks are the property of their respective companies.  
D2003384 REV 001

**Model 72958  
SMA PLUG R/A CRIMP, RG58**

**Cable Types and Crimp Die Information**

Connector Model #	Cable Groups	Crimp Die Cavity Size for Outer Ferrule
72958	RG58	.213 (5.4)

**Cable Assembly Instructions**

1. CUT CABLE END EVENLY AND PERPENDICULAR

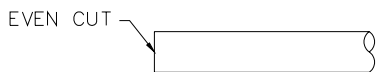

2. SLIDE OUTER FERRULE OVER CABLE END.

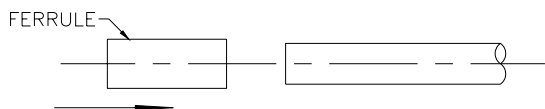

3. STRIP CABLE JACKET, BRAID, AND DIELECTRIC TO SPECIFICATION LENGTHS.

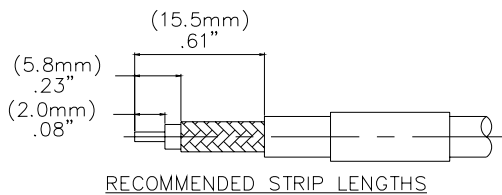

4. FLARE BRAID END SLIGHTLY.

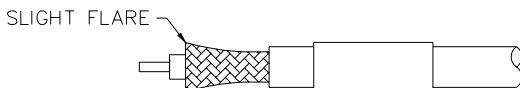

5. SLIDE CONNECTOR BODY OVER CENTER CONDUCTOR AND DIELECTRIC. SLIDE OUTER FERRULE OVER BRAID AND UP AGAINST BODY ASSEMBLY.

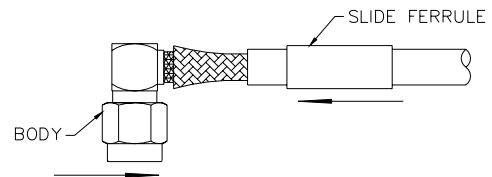

6. SCREW ON CAP AS SHOWN. SLIDE OUTER FERRULE OVER BRAID AND UP AGAINST BODY ASSEMBLY.

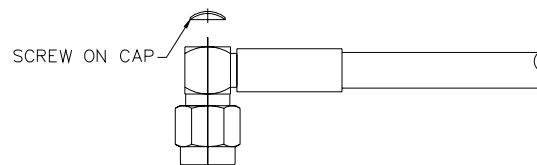

7. CRIMP OUTER FERRULE WITH APPROPRIATE CRIMP TOOL.

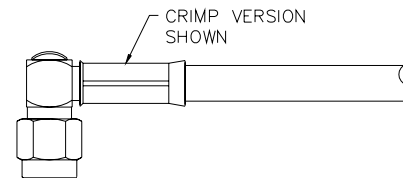

**USA:** Sales: 800-490-2361  
 Technical Support: [technicalsupport@pomonatest.com](mailto:technicalsupport@pomonatest.com)  
 Fax: 425-446-5844  
**Europe:** 31-(0) 40 2675 150 **International:** 425-446-5500  
**Where to Buy:** [www.pomonaelectronics.com](http://www.pomonaelectronics.com)

All dimensions are in inches. Tolerances (except noted): .xx = ±.02" (.51 mm), .xxx = ±.005" (.127 mm). All specifications are to the latest revisions. Specifications are subject to change without notice. Registered trademarks are the property of their respective companies.  
 D2003384 REV 001