

REV.	DATE	DESCRIPTION
A	10/12/03	MODIFY DRAWING FORMAT

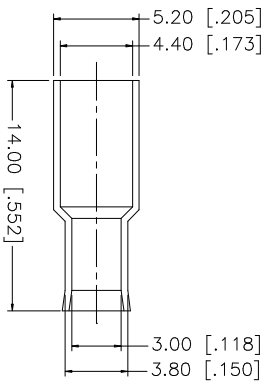
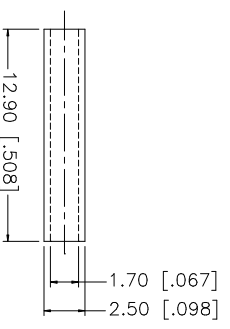
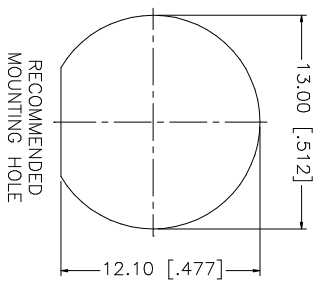
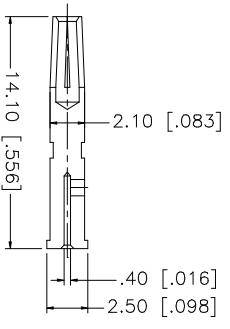
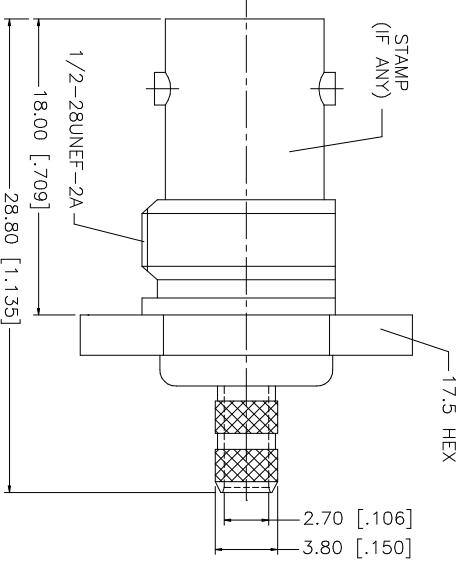
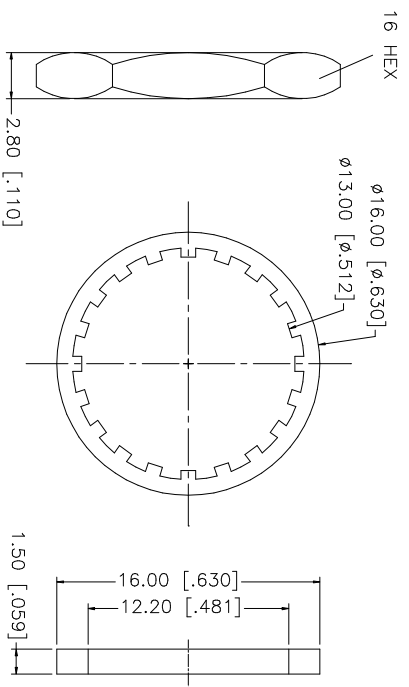
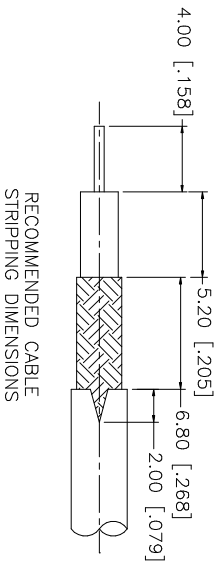

- NOTE:
1. CRIMPED FERRULE HEX CRIMP SIZE .178"
 2. CRIMPED CONTACT PIN HEX CRIMP SIZE .068"

QTY	DESCRIPTION	MATERIAL	FINISH
1	FERRULE	COPPER	NICKEL
1	SLEEVE	DELRIIN	NATURAL
1	HEX NUT	BRASS	NICKEL
1	LOCK WASHER	BRASS	NICKEL
1	GASKET	RUBBER	RED
1	CONTACT PIN	PHOS. BRONZE	GOLD
1	INSULATOR	DELRIIN	NATURAL
1	BODY	BRASS	NICKEL

APPROVALS	DATE
DRAWN G.R.S.	10/12/03
CHECKED	
ISSUED	
SHEET 1 OF 1	

UNLESS OTHERWISE SPECIFIED DIMENSIONS ARE IN MILLIMETERS. DIMENSIONS IN [] ARE IN INCHES AND FOR CUSTOMER REFERENCE ONLY.
UNLESS OTHERWISE SPECIFIED TOLERANCES FOR MILLIMETERS ARE: 0.5 - 8mm ± 0.20mm 8 - 30mm ± 0.40mm 30 - 120mm ± 0.50mm
UNLESS OTHERWISE SPECIFIED TOLERANCES FOR INCHES ARE: .020 - .315 = ± 0.007" .315 - 1.180 = ± 0.015" 1.180 - 4.724 = ± 0.020"

DO NOT SCALE DRAWING
CAD FILE C:/112/112235.DWG

DWG. NO.	REV.	SIZE	SCALE
112235.DWG	A	A	NA

Amphenol Connex

BNC BULKHEAD CRIMP JACK
(FOR RG-179/U, 187A/U)

112235