

Description

- High contact density
- Bayonet coupling
- Contact protection : 100% Scoop proof
- Shell size from 9 to 25
- Accessories available (protective caps, backshells, etc...)
- RFI - EMI shielding and shell to shell continuity
- Hermetic
- Aluminium alloy, protection by cadmium, nickel, green zinc cobalt or black zinc nickel plating

Applications

- Civil and Military Aerospace
- Marine Equipments
- Communications Equipments
- Medical Instrumentation
- Ballistic Missiles & Weapon Systems
- Armored Carriers & Tanks
- Test Equipments

Technical features

Mechanical

- Shell: aluminum alloy
- Plating:
 - . olive green cadmium (B)
 - . nickel (F)
 - . green zinc cobalt (Z)
 - . black zinc nickel (L)
- Insulator: thermoplastic or metallic version available for specification 284 & 384
- Grommet or seal: liquid silicone rubber or fluorocarbene elastomer for specification 022
- Contact: copper alloy
- Plating contact: gold over nickel
- Endurance: 500 mating / unmating operations

- Chock: 300 g during 3 ms and as per MIL S 901 grade A
- Vibration:
 - . Sine 10 to 2000 Hz - 30 g
 - . Random 100 à 300 Hz - 5 g²/Hz
- Contact retention (min force in N):
 - . Size 22D: 44 N
 - . Size 12: 111 N
 - . Size 20: 67 N
 - . Size 8: 111 N
 - . Size 16: 111 N
 - . Size 4: 200 N

Electrical

- Test voltage (Vrms)

Service	sea level	at 21 000 m
M	1 300	800
N	1 000	600
I	1 800	1 000
II	2 300	1 000

- Insulation resistance: $\geq 5\ 000\ \text{MW}$ (at 500 Vcc)
- Contact resistance:
 - resistance of wire included in measurement
 - . size 22D: 14.6 m Ω
 - . size 12: 3.5 m Ω
 - . size 20: 7.3 m Ω
 - . size 8: 3 m Ω
 - . size 16: 3.8 m Ω
 - . size 4: 2 m Ω
- Contact rating:
 - . size 22D: 5 A
 - . size 12: 23 A
 - . size 20: 7.5 A
 - . size 8: 45 A
 - . size 16: 13 A
 - . size 4: 80 A
- Shell continuity:
 - . olive green plating: 2.5 m Ω
 - . nickel plating: 1 m Ω
 - . green zinc cobalt: 2.5 m Ω
 - . black zinc nickel: 2.5 m Ω

- Shielding: 90 db at 100 MHz, 50 db at 10 000 MHz
- Electrical continuity between contact and shell for specification 284 & 384: 10 m Ω max

Climatic

- Temperature range:
 - . olive green cadmium plating (B)
 - 65°C +175°C
 - . nickel plating (F)
 - 65°C +200°C
 - . green zinc cobalt plating (Z)
 - 65°C +200°C
 - . black zinc nickel plating (L)
 - 65°C +200°C
- Sealing: mated connectors
 - Differential pressure 2 bars:
 - leakage $\leq 16\ \text{cm}^3/\text{h}$
- Salt spray as per:
 - . MIL STD 1344 method 1001 :
 - 500 hours (versions B, L and Z)
 - 48 hours (version F)
 - . NFC 93422 :
 - 48 hours (version F)
- Resistance to fluids
 - . As per MIL DTL 38999, hydraulic fluids, solvents
 - . Specification 022 for fuel immersion (please consult us)



Cross reference list :

Part Numbers Souriau and Specifications : NFC 93422 / MIL DTL 38999

Connectors

SOURIAU	NFC 93422 HE 308	MIL DTL 38999 Serie I	Designation
8LT0●●●B●●●P/SN 8LT0●●●F●●●P/SN	HE30800T●●●●●P/SN7 M HE30800T●●●●●P/SN6 M	MS27466T●●●B●●●P/S●* MS27466T●●●F●●●P/S●*	Square flange receptacle
8LT1●●●B●●●P/SN 8LT1●●●F●●●P/SN	- -	- -	Cable connecting receptacle
8LT2●●●B●●●P/SN 8LT2●●●F●●●P/SN	- -	MS27505E●●●B●●●P/S●* MS27505E●●●F●●●P/S●*	Square flange receptacle not accepting backshell
8LT3●●●B●●●P/SN 8LT3●●●F●●●P/SN	- -	MS27656T●●●B●●●P/S●* MS27656T●●●F●●●P/S●*	Square flange receptacle (rear mounting)
8LT5●●●B●●●P/SN 8LT5●●●F●●●P/SN	HE30806T●●●●●P/SN7 M HE30806T●●●●●P/SN6 M	MS27467T●●●B●●●P/S●* MS27467T●●●F●●●P/S●*	Plug with RFI shielding
8LT15●●●B●●●P/SN 8LT15●●●F●●●P/SN	- -	MS27467E●●●B●●●P/S●* MS27467E●●●F●●●P/S●*	Plug with RFI shielding not accepting backshell
8LT7●●●B●●●P/SN 8LT7●●●F●●●P/SN	HE30807T●●●●●P/SN7 M HE30807T●●●●●P/SN6 M	MS27468T●●●B●●●P/S●* MS27468T●●●F●●●P/S●*	Jam nut receptacle
8LT7S●●●B●●●P/SN (#22D) 8LT7S●●●F●●●P/SN (#22D)	HE30811T●●●●●P/SN7 M HE30811T●●●●●P/SN6 M	- -	Jam nut receptacle with straight spill contacts
8LT7C●●●B●●●P/SN (#20, #16, #12) 8LT7C●●●F●●●P/SN (#20, #16, #12)	HE30811T●●●●●P/SN7 M HE30811T●●●●●P/SN6 M	- -	Jam nut receptacle with straight spill contacts
8LT26●●●B●●●P/SN 8LT26●●●F●●●P/SN	HE30826T●●●●●P/SN7 M -	- -	Floating plug for rack HE308
8LT27●●●B●●●P/SN 8LT27●●●F●●●P/SN	HE30827T●●●●●P/SN7 M -	- -	Receptacle for rack HE308 with possibility to mount rear accessories
8LT27S●●●B●●●P/SN (#22D) 8LT27C●●●B●●●P/SN (#20, #16, #12)	HE30821T●●●●●P/SN7 M HE30821T●●●●●P/SN7 M	- -	Receptacle for rack HE308 with straight spill contacts
8LT23●●●B●●●P/SN	-	-	Square flange receptacle

* Standard P/S : . None = N position,
. Use A,B,C,D for other orientations

Backshells

SOURIAU	NFC 93422 HE 308	MIL DTL 38999 Serie I	Designation
8LST●●●●B01 8LST●●●●F01	- -	M8504927●●●W M8504927●●●N	Backnut
8LST●●●●B02 8LST●●●●F02 8LST●●●●G02	- HE308-11●●●26 HE308-11●●●27	- - -	Straight cable clamp
8LST●●●●B03 8LST●●●●F03 8LST●●●●G03	- HE308-12●●●26 HE308-12●●●27	- - -	Elbow cable clamp
8LST●●●●B071 8LST●●●●F071	HE308-13●●●17 HE308-13●●●16	- -	Backshell for screen termination and heatshrink sleeving



Caps

SOURIAU	NFC 93422 / HE 308	MIL DTL 38999 Serie I	Designation
8LTE04B●● 8LTE04F●●	HE308-B00●●7 HE308-B00●●6	- -	Cap for square flange receptacle
8LTE06B●● 8LTE06F●●	HE308-B07●●7 HE308-B07●●6	- -	Cap for jam nut receptacle
8LTF05B●● 8LTF05F●●	HE308-B16●●7 HE308-B16●●6	- -	Cap for plug
8LTF07B●● 8LTF07F●●	HE308-B06●●7 HE308-B06●●6	- -	Cap for plug
8LTE01B●● 8LTE01F●●	- -	MS27502B●●C MS27502F●●C	Cap for receptacle
8LTE02B●● 8LTE02F●●	- -	MS27502B●●N MS27502F●●N	Cap for receptacle
8LTF01B●● 8LTF01F●●	- -	MS27501B●●C MS27501F●●C	Cap for plug

Contacts

See pages «Contacts»

Filler plug

Contact size	Part Number		Colour
	SOURIAU	MIL DTL 38999 serie I	
#22D	8660-212	MS27488-22	Black
#20	8522-389A	MS27488-20	Red
#16	8522-390A	MS27488-16	Blue
#12	8522-391A	MS27488-12	Yellow

Insertion and extraction tools

Contact size	Part Number		Colour	
	SOURIAU	MIL DTL 38999 Serie I	Insertion	Extraction
#22D	8599-0022	M81969/14-01	Green	White
#20	8522-20	M81969/14-10	Red	Orange
#16	8522-16	M81969/14-03	Blue	White
#12	8522-12	M81969/14-04	Yellow	White



Mated connectors with backshells

Mated plug : Dimension from panel to backshell

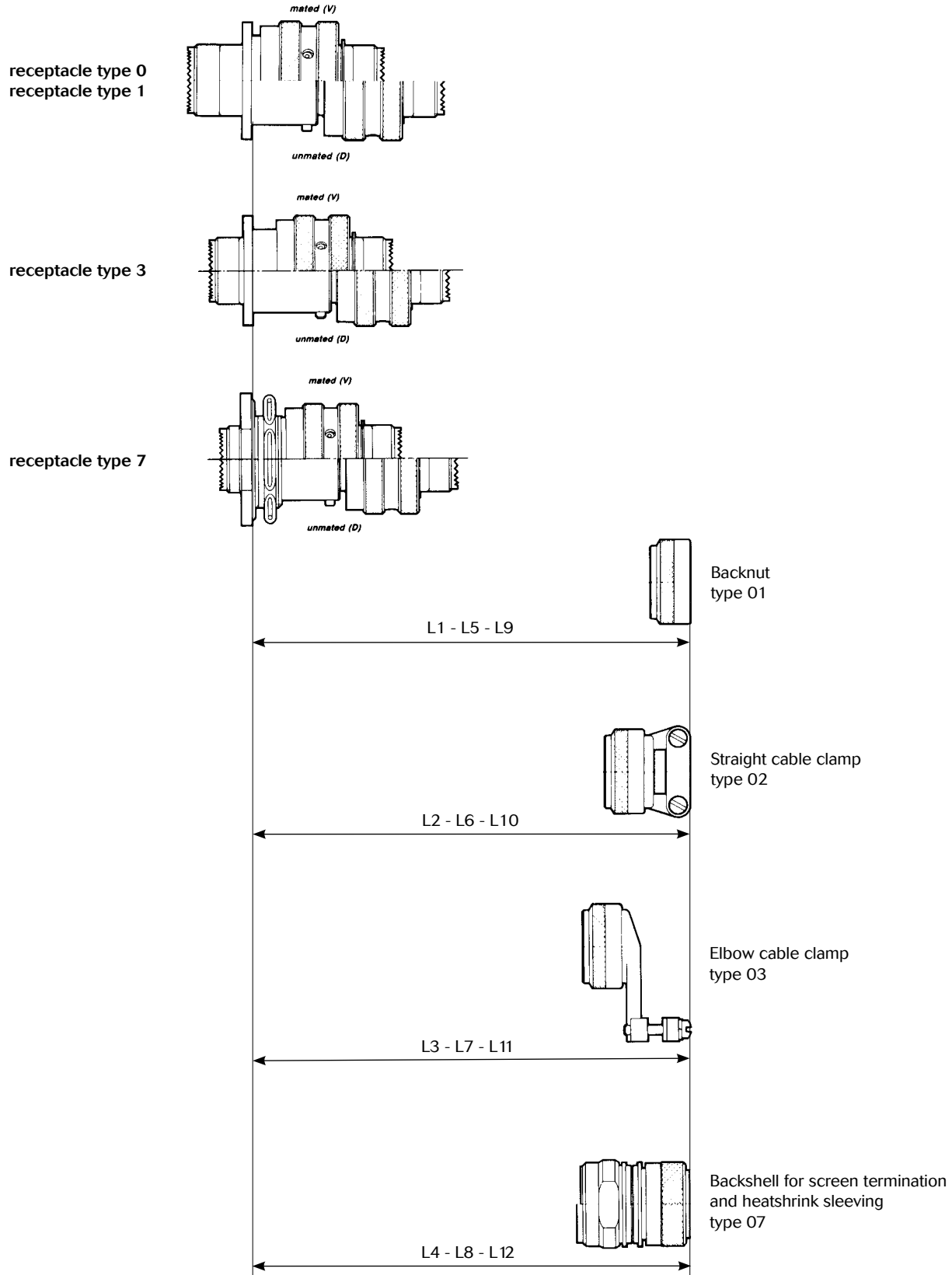



Square flange receptacle type 0 Cable connecting receptacle type 1								
Shell size	L1 Max		L2 Max		L3 Max		L4 Max	
	V	D	V	D	V	D	V	D
09	40.20	55.20	50.75	65.75	64.20	79.20	55.75	70.75
11	40.20	55.20	51.75	66.55	64.20	79.20	55.75	70.75
13	40.20	55.20	53.05	68.05	66.20	81.20	55.75	70.75
15	40.20	55.20	59.45	74.45	70.56	85.56	57.75	72.75
17	40.20	55.20	62.95	77.95	74.93	89.93	57.75	72.75
19	40.20	55.20	62.95	77.95	75.34	90.34	58.75	73.75
21	40.20	55.20	62.95	77.95	77.32	92.32	62.55	77.55
23	40.20	55.20	62.95	77.95	80.87	95.87	62.55	77.55
25	40.20	55.20	62.95	77.95	83.67	98.67	62.55	77.55

Square flange receptacle type 3								
Shell size	L5 Max		L6 Max		L7 Max		L8 Max	
	V	D	V	D	V	D	V	D
09	42.50	57.50	53.05	68.05	66.50	81.50	58.05	72.05
11	42.50	57.50	54.05	68.05	66.50	81.50	58.05	72.05
13	42.50	57.50	55.80	7.35	65.50	83.50	58.05	72.05
15	42.50	57.50	61.75	76.75	78.86	87.86	60.05	75.05
17	42.50	57.50	65.25	80.25	77.23	92.23	60.05	75.05
19	42.50	57.50	65.25	80.25	77.64	92.64	61.05	76.05
21	41.75	56.75	64.50	79.50	78.87	93.87	64.10	79.10
23	41.75	56.75	64.50	79.50	82.42	97.42	64.10	79.10
25	41.75	56.75	64.50	79.50	85.22	100.22	64.10	79.10

Jam nut receptacle type 7								
Shell size	L9 Max		L10 Max		L11 Max		L12 Max	
	V	D	V	D	V	D	V	D
09	45.02	60.02	55.58	70.58	69.04	84.04	60.58	75.58
11	45.02	60.02	56.38	71.38	69.04	84.04	60.58	75.58
13	45.02	60.02	57.88	72.88	71.02	84.04	60.58	75.58
15	45.02	60.02	64.28	79.28	75.39	86.02	62.58	77.58
17	45.02	60.02	67.78	82.78	79.76	90.39	62.58	77.58
19	45.02	60.02	67.78	82.78	80.17	94.76	63.58	78.58
21	45.02	60.02	67.78	82.78	82.15	95.17	67.38	82.38
23	45.02	60.02	67.78	82.78	85.70	100.70	67.38	82.38
25	45.02	60.02	67.78	82.78	88.50	103.50	67.38	82.38



Plug or receptacle backshell assembly overall length

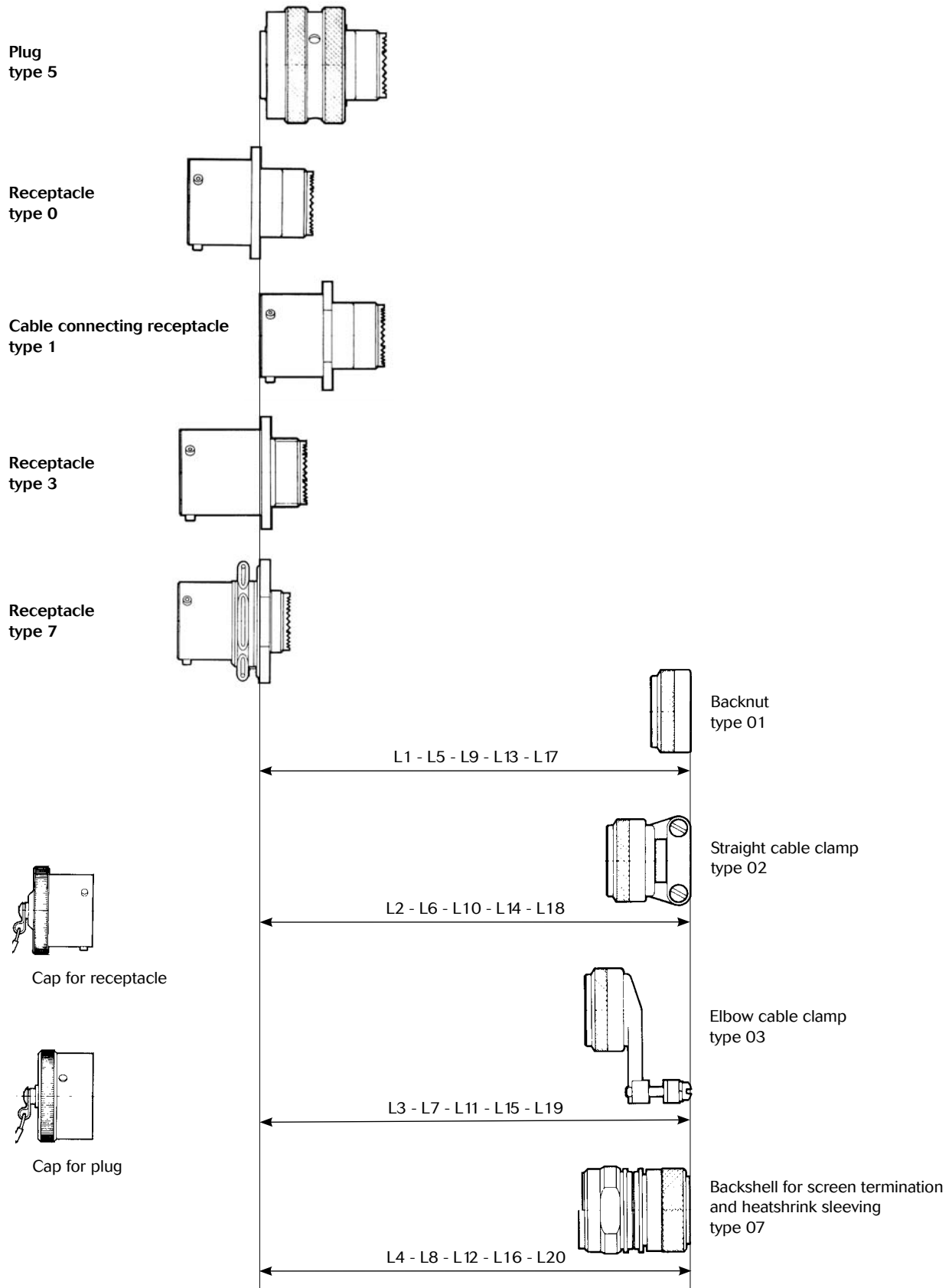

8LT Series



Plug type 5				
Shell size	L1 Max	L2 Max	L3 Max	L4 Max
09	36.66	47.22	60.68	52.22
11	36.66	48.02	60.68	52.22
13	36.66	49.52	62.66	52.22
15	36.66	55.92	67.03	54.22
17	36.66	59.42	71.40	54.22
19	36.66	59.42	71.81	55.22
21	36.66	59.42	73.79	59.02
23	36.66	59.42	77.34	59.02
25	36.66	59.42	80.14	59.02

Receptacle type 0				
Shell size	L5 Max	L6 Max	L7 Max	L8 Max
09	18.83	29.39	42.85	34.39
11	18.83	30.19	42.85	34.39
13	18.83	31.69	44.83	34.39
15	18.83	38.09	51.00	36.39
17	18.83	41.59	53.57	36.39
19	18.83	41.59	53.98	37.39
21	18.83	41.59	55.98	41.19
23	18.83	41.59	59.51	41.19
25	18.83	41.59	62.31	41.19

Cable connecting receptacle type 1				
Shell size	L9 Max	L10 Max	L11 Max	L12 Max
09	37.36	47.98	61.38	52.92
11	37.36	48.72	61.38	52.92
13	37.36	50.22	63.36	52.92
15	37.36	56.62	69.53	54.92
17	37.36	60.12	72.10	54.92
19	37.36	60.12	72.51	55.92
21	37.36	60.12	74.49	59.72
23	37.36	60.12	78.04	59.72
25	37.36	60.12	80.84	59.72

Receptacle type 3				
Shell size	L13 Max	L14 Max	L15 Max	L16 Max
09	15.85	26.40	39.90	31.40
11	15.85	27.20	39.90	31.40
13	15.85	28.70	41.90	31.40
15	15.85	35.10	48.10	33.40
17	15.85	38.60	50.60	33.40
19	15.85	38.60	51.00	34.40
21	15.85	39.40	53.80	39.00
23	15.85	39.40	57.30	39.00
25	15.85	39.40	60.10	39.00

Receptacle type 7				
Shell size	L17 Max	L18 Max	L19 Max	L20 Max
09	13.66	24.22	37.68	29.22
11	13.66	25.22	37.68	29.22
13	13.66	26.52	39.66	29.22
15	13.66	32.92	45.83	31.22
17	13.66	36.42	48.40	31.22
19	13.66	36.42	48.81	32.22
21	13.66	36.42	50.79	36.02
23	13.66	36.42	54.34	36.02
25	13.66	36.42	57.14	36.02



Mated connectors dimensions

Type 0 with plug
(type 5)

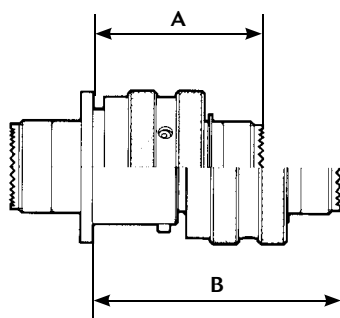

Type 7 with plug
(type 5)

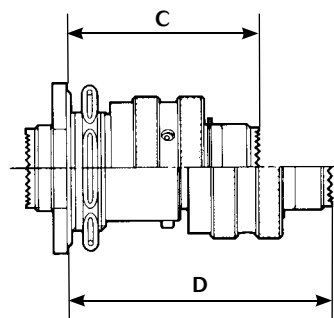











Shell Size	A Max	B Max	C Max	D Max
09	33.30	47.40	40.60	54.70
11				
13				
15				
17				
19	32.50	46.70	40.60	54.70
21				
23				
25				









Contact layouts

09

<p>35</p>  <p>6#22D</p> <p>Service M</p>	<p>98</p>  <p>3#20</p> <p>Service I</p>
--	---

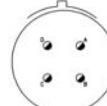
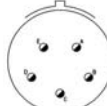
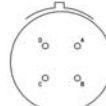
- | | |
|--|--|
| <ul style="list-style-type: none">  Contact #22D  Contact #20  Contact #16  Contact #12  Contact #10 | <ul style="list-style-type: none">  Contact #8  Contact #8 Power  Contact #8 Quadrax  Contact #4 Power |
|--|--|

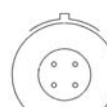
11

<p>01</p>  <p>1#12</p> <p>Service II</p>	<p>02</p>  <p>2#16</p> <p>Service I</p>	<p>04</p>  <p>4#20</p> <p>Service I</p>	<p>05</p>  <p>5#20</p> <p>Service I</p>	<p>22*</p>  <p>4#22D</p> <p>Service M</p>
<p>35</p>  <p>13#22D</p> <p>Service M</p>	<p>80</p>  <p>1#8 triax</p> <p>Service I</p>	<p>81</p>  <p>1#8 quadrax</p>	<p>98</p>  <p>6#20</p> <p>Service I</p>	<p>99</p>  <p>7#20</p> <p>Service I</p>

13

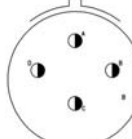
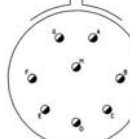
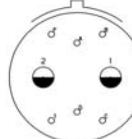
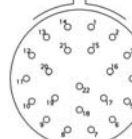
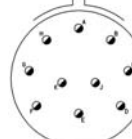
<p>03</p>  <p>3#16</p> <p>Service I</p>	<p>04</p>  <p>4#16</p> <p>Service I</p>	<p>08</p>  <p>8#20</p> <p>Service I</p>	<p>26</p>  <p>6#22D 2#12</p> <p>Service M</p>	<p>35</p>  <p>22#22D</p> <p>Service M</p>	<p>98</p>  <p>10#20</p> <p>Service I</p>
---	---	---	---	---	--

8LT Series



15

05

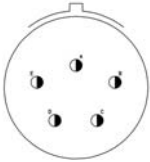

5#16

Service II

15

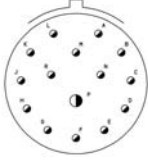

14#20
1#16

Service I

18

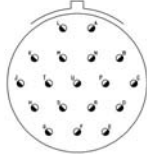

18#20

Service I

19

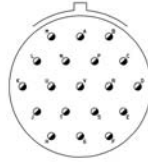

19#20

Service I

35

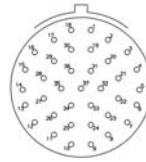

37#22D

Service M

97

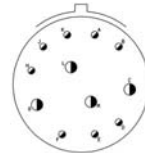

8#20
4#16

Service I

17

02

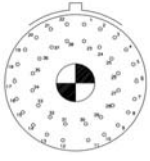

38#22D
1#8 triax
Service M

06*

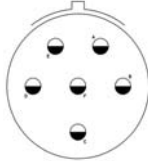

6#12
or 6#12 Coax
Service I

08

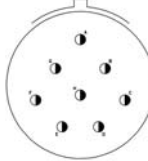

8#16

Service II

20*

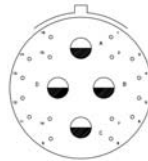

16#22D
4#12
Service M

22

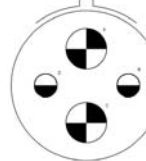

2#12
2#8 triax
Service M

26

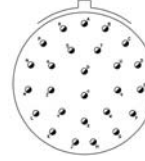

26#20

Service I

35

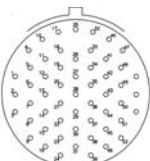

55#22D

Service M

75

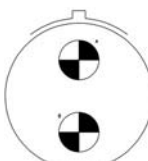

2#8 triax

Service M

80

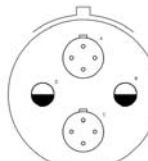

2#12
2#8 quadrax

81

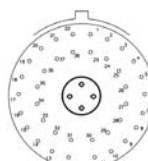

38#22D
1#8 quadrax

82

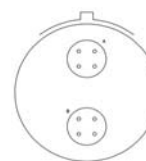

2#8 quadrax

99



2#16
21#20
Service I

19

11

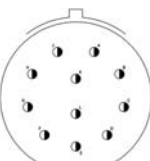

11#16

Service II

18

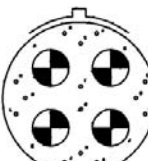

14#22D
4#8 triax
Service M

28

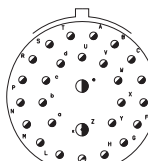

26#20
2#16
Service I

32



32#20

Service I

35

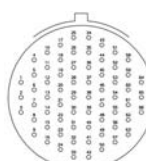

66#22D

Service M

84

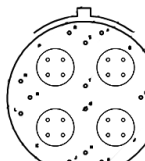

14#22D
4#8 quadrax



21

11

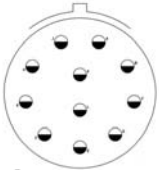

11#12

Service I

16

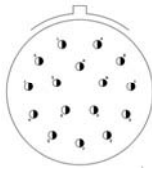

16#16

Service II

35

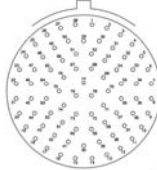

79#22D

Service M

39

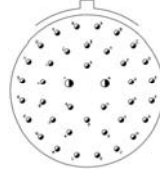

37#20

2#16
Service I

41



41#20

Service I

42



2#4 power

Service I

48

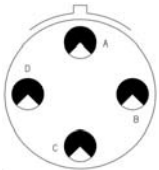

4#8 power

Service I

72

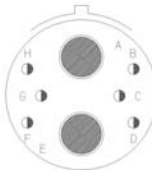

2#4 power
6#12

Service I

75

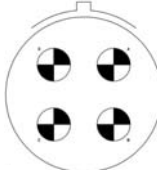

4#8 triax

Service M

78

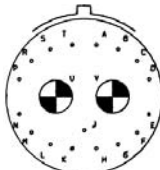

17#22D
2#8 coax
Service M

84

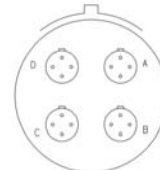

4#8 quadrax

23

21

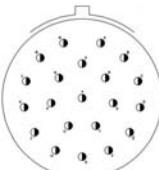

21#16

Service I

32

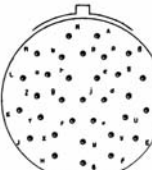

32#20

Service I

35

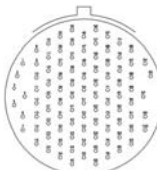

100#22D

Service M

53



53#20

Service I

54

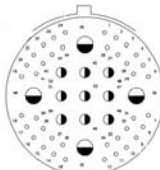

40#22D

9#16
4#12
Service M

55

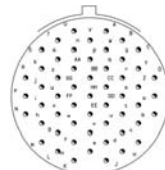

55#20

Service I

8LT Series



25

04

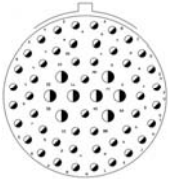

48#20
8#16
Service I

07

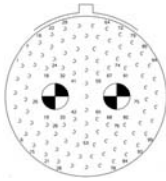

97#22D
2#8 triax
Service M

08*

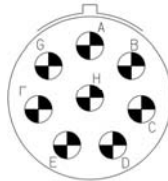

8#8 triax
Service M

11*

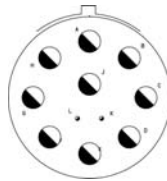

2#20
9#10
Service N

19

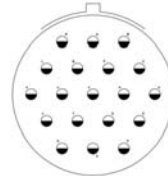

19#12
Service I

24

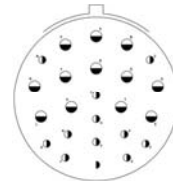

12#12
12#16
Service II

29

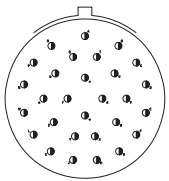

29#16
Service I

35

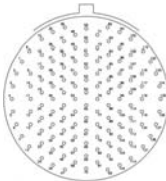

128#22D
Service M

37

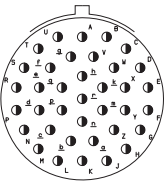

37#16
Service I

41

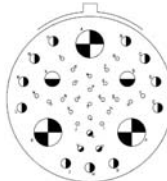

22#22D
3#20
11#16
2#12
3#8 triax
Service N

43

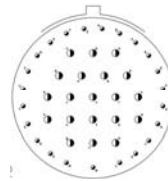

20#16
23#20
Service I

44

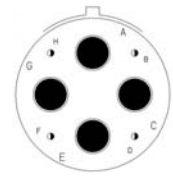

4#4 power
4#16
Service I

46



40#20
4#16
2#8 coax
Service I

61



61#20
Service I

81



22#22D
3#20
11#16
2#12
3#8 quadrax

82

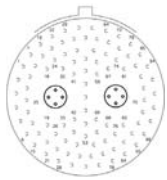

97#22D
2#8 quadrax

86

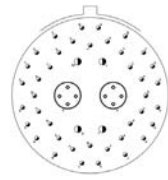

40#20
4#16
2#8 quadrax

88*

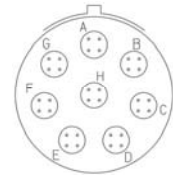

8#8 quadrax

90



40#20
4#16
2#8 triax
Service I

* Available on specific request. Please consult us.

Ethernet Quadrax



Contact layouts (matrix)

Shell Size	Layout	Service	8LT	8LT2	MIL - DTL - 38999 (QPL)		HE 308		Nber of Contacts	# 22D	# 20	# 16	# 12	# 10	# 8	#4 Power
					MS (1)	MS27505	Not Rack	Rack								
09 / A	09 - 35	M					O	X		6	6					
	09 - 98	I					O	X		3	3					
11 / B	11 - 01	II							*	1			1			
	11 - 02	I							*	2		2				
	11 - 04	I							*	4	4					
	11 - 05	I							*	5	5					
	11 - 22	M								4	4					
	11 - 35	M						O	X	*	13	13				
	11 - 80	I								1					1 Triax	
	11 - 81	-								1					1 Quadrax	
	11 - 98	I						O	X	*	6	6				
11 - 99	I								*	7	7					
13 / C	13 - 03	I								3		3				
	13 - 04	I					O		*	4		4				
	13 - 08	I							*	8	8					
	13 - 26	M								8	6		2			
	13 - 35	M						O	X	*	22	22				
	13 - 98	I						O	X	*	10	10				
15 / D	15 - 05	II						O	X	*	5		5			
	15 - 15	I							*	15	14	1				
	15 - 18	I						O		*	18	18				
	15 - 19	I						O	X	*	19	19				
	15 - 35	M						O	X	*	37	37				
	15 - 97	I						O	X	*	12	8	4			
17 / E	17 - 02	M								39	38				1 Triax	
	17 - 06	I					O		*	6	6					
	17 - 08	II					O	X	*	8		8				
	17 - 20	M								20	16		4			
	17 - 22	M								4			2		2 Triax	
	17 - 26	I					O	X	*	26	26					
	17 - 35	M					O	X	*	55	55					
	17 - 75	M							*	2					2 Triax	
	17 - 80	-								4			2		2 Quadrax	
	17 - 81	-								39	38				1 Quadrax	
	17 - 82	-								2					2 Quadrax	
17 - 99	I						O	X	*	23	21	2				
19 / F	19 - 11	II					O	X	*	11		11				
	19 - 18	M								18	14				4 Triax	
	19 - 28	I							*	28	26	2				
	19 - 32	I					O	X	*	32	32					
	19 - 35	M					O	X	*	66	66					
19 - 84	-								18	14				4 Quadrax		

(1) available MS27466 & MS27467 & MS27468 & MS27656

	SOURIAU's layout
	Qualified Layout (QPL) MIL - DTL 38999

X Qualified Layout HE308 for «ministère de la défense» DGA DTAT
 O Layout according to UTE C 93-422 norm
 * Layout according to C5935X0005 norm

8LT Series



Contact layouts (matrix)

Shell Size	Layout	Service	8LT	8LT2	MIL - DTL - 38999 (QPL)		HE 308		Nber of Contacts	# 22D	# 20	# 16	# 12	# 10	# 8	#4 Power
					MS (1)	MS27505	Not Rack	Rack								
21 / G	21 - 11	I					O	X	*	11			11			
	21 - 16	II					O	X	*	16		16				
	21 - 35	M					O	X	*	79	79					
	21 - 39	I					O		*	39		37	2			
	21 - 41	I					O	X	*	41		41				
	21 - 42	I								2						2
	21 - 48	I								4					4 Power	
	21 - 72	I								8		6				2
	21 - 75	-							*	4					4 Triax	
	21 - 78	M								19	17				2 Coax	
21 - 84	-								4					4 Quadrax		
23 / H	23 - 21	II					O		*	21		21				
	23 - 32	I								32		32				
	23 - 35	M					O	X	*	100	100					
	23 - 53	I					O	X	*	53		53				
	23 - 54	M								53	40	9	4			
	23 - 55	I							*	55		55				
25 / J	25 - 04	I								56		48	8			
	25 - 07	M								99	97				2 Triax	
	25 - 08	-								8					8 Triax	
	25 - 11	N								11		2		9		
	25 - 19	I					O	X		19			19			
	25 - 24	II								24		12	12			
	25 - 29	I					O	X		29		29				
	25 - 35	M					O	X		128	128					
	25 - 37	I								37		37				
	25 - 41	N								41	22	3	11	2		3 Triax
	25 - 43	I								43		23	20			
	25 - 44	I								8		4				4
	25 - 46	I								46		40	4			2 Coax
	25 - 61	I					O	X		61		61				
	25 - 81	N								41	22	3	11	2		3 Quadrax
	25 - 82	M								99	97					2 Quadrax
25 - 86	I								46		40	4			2 Quadrax	
25 - 88	-								8						8 Quadrax	
25 - 90	I								46		40	4			2 Triax	

(1) available MS27466 & MS27467 & MS27468 & MS27656

	SOURIAU's layout
	Qualified Layout (QPL) MIL - DTL 38999

- X Qualified Layout HE308 for «ministère de la défense» DGA DTAT
- O Layout according to UTE C 93-422 norm
- * Layout according to C5935X0005 norm



Souriau connector part numbers

Basic series	8LT	0	-	13	B	35	P	N	***	-	L
Shell type 0: Square flange receptacle 1: Cable connecting receptacle 2: Short square flange receptacle, not accepting backshell 3: Square flange receptacle (rear mounting) 5: Plug with RFI shielding 7: Jam nut receptacle 15: Plug with RFI shielding, not accepting backshell											
Type None: Connector with standard crimp contacts L: Connector with long spill (male and female #22D) C: Connector with short spill (male and female #22D, #20, #16, #12, #8 quadrax) T: Connector with male contact size 20 for wire wrap (2 wraps) W: Connector with male contact size 22D for wire wrap (3 wraps) S: Connector with specific straight spill (male and female #22D only) Q: Connector with quadrax crimp contacts P: Connector with solder cup: . Pin: #22D & #16; Socket: #12 . Socket: #22D & #16; Pin: #12 - Please consult us											
Shell size 09 - 11 - 13 - 15 - 17 - 19 - 21 - 23 - 25											
Plating F: Nickel B: Olive green cadmium Z: Green zinc cobalt L: Black zinc nickel											
Contact layout See tables «Contact Layouts»											
Contact type P: Male A: Connector supplied less pin contact or with specific contacts (Connector marking : A + orientation) S: Female B: Connector supplied less socket contact or with specific contacts (Connector marking : B + orientation)											
Orientation (1) N, A, B, C, D see table «Orientations»											
Specifications None: Supplied with contact 046: Straight spill contact with tinned plating 251: Connector provided with power contacts with layout contacts #8 022: Fuel tank Please consult us *284: Quadrax grounded (cts 100) (2) 308: Quadrax not grounded (cts 100) (2) *384: Quadrax grounded (cts 150) (2) 408: Quadrax not grounded (cts 150) (2)											
Special custom None: Standard plastic cap M: Antistatic plastic cap											
L: For P or S contact type only, connector delivered without contacts, connector marking P or S (without L)											

*Excepted mixed layouts with quadrax and signal contacts. Please consult us.

(1) Orientations B & C not developed for shell size number 9.

(2) Type shell 0, 3 and 5 available only.



MIL DTL 38999 part numbers

Basic series	MS	27466	T	13	B	35	P	-	-	L
Shell type										
27466: Square flange receptacle (front mounting)										
27656: Square flange receptacle (rear mounting)										
27468: Jam nut receptacle										
27467: Plug with RFI shielding										
27505: Square flange receptacle, not accepting backshell										
Class										
E: Without thread for back fitting, not accepting backshell for MS27505 and MS27467 only										
T: With thread for backfitting, supplied without backshell (excepted MS27505)										
Shell size										
09 - 11 - 13 - 15 - 17 - 19 - 21 - 23 - 25										
Plating										
F: Nickel B: Olive green cadmium										
Contact layout										
See tables «Contact Layouts»										
Contact type										
P: Male A: Connector supplied less pin contact or with specific contacts (Connector marking : A + orientation)										
S: Female B: Connector supplied less socket contact or with specific contacts (Connector marking : B + orientation)										
Orientation (1)										
None: Normal (N)										
A, B, C, D see table «Orientations»										
Special custom										
None: Standard plastic cap										
M: Antistatic plastic cap										
L: For P or S contact type only, connector delivered without contacts, connector marking P or S (without L)										

(1) Orientations B & C not developed for shell size number 9.



HE 308 part numbers

Basic series	HE308	00	T	13	35	P	N	7	M	-	L
Shell type											
00: Square flange receptacle											
07: Jam nut receptacle											
06: Plug with RFI shielding											
11: Jam nut receptacle with straight spill contacts											
Class											
T: Sealed											
Shell size											
09 - 11 - 13 - 15 - 17 - 19 - 21 - 23 - 25											
Contact layout											
See tables «Contact Layouts»											
Contact type											
P: Male											
S: Female											
Orientation (1)											
N, A, B, C, D see table «Orientations»											
Plating											
6: Nickel											
7: Olive green cadmium											
Contractual spécification											
Special custom											
None: Standard plastic cap											
M: Antistatic plastic cap											
Specification											
None: Connector supplied with contact											
L: connector supplied without contact											

(1) Orientations B & C not developed for shell size number 9.



Dimensions

Receptacle type 0

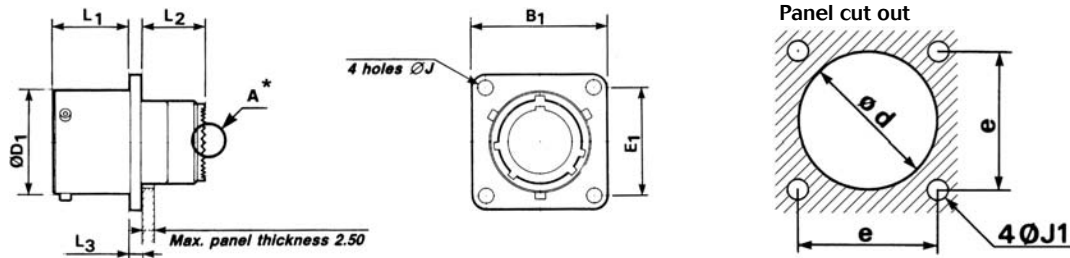

Shell size		09	11	13	15	17	19	21	23	25
B1	Min	23.70	26.05	28.50	30.85	33.20	36.40	39.55	42.75	46.00
	Max	24.30	26.70	29.05	31.45	33.80	37.00	40.15	43.35	46.50
E1		18.26	20.62	23.01	24.61	26.97	29.36	31.75	34.93	38.10
D1	Min	14.40	17.65	21.40	24.65	27.82	29.24	33.70	36.92	40.06
	Max	14.53	17.78	21.59	24.77	27.94	30.66	33.83	37.00	40.18
J	Min	3.25	3.25	3.25	3.25	3.25	3.25	3.25	3.73	3.73
	Max	3.35	3.35	3.35	3.35	3.35	3.35	3.35	3.83	3.83
L1	Min	15.93	15.93	15.93	15.93	15.93	15.93	15.17	15.17	15.17
	Max	16.05	16.05	16.05	16.05	16.05	16.05	15.29	15.29	15.29
L2	Min	13.23	13.23	13.23	13.23	13.23	13.23	13.23	13.23	13.23
	Max	13.49	13.49	13.49	13.49	13.49	13.49	13.49	13.49	13.49
L3	Min	2.14	2.14	2.14	2.14	2.14	2.14	2.90	2.90	2.90
	Max	2.54	2.54	2.54	2.54	2.54	2.54	3.30	3.30	3.30
d	Min	15.70	18.70	21.80	25.00	28.30	31.00	34.20	37.30	40.50
J1	± 0.15	3.25	3.25	3.25	3.25	3.25	3.25	3.25	3.91	3.91
e		18.26	20.62	23.01	24.61	26.97	29.36	31.75	34.92	38.10

* See Detail A

Cable connecting receptacle type 1

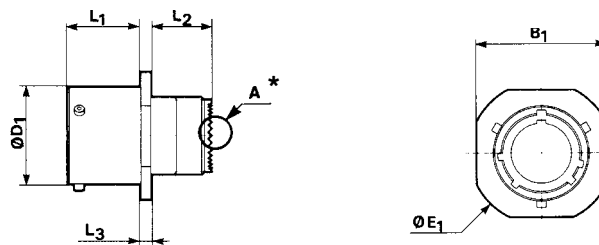

Shell size		09	11	13	15	17	19	21	23	25
B1	Min	18.35	21.65	25.05	27.25	30.78	34.05	37.45	41.45	45.93
	Max	18.92	22.22	25.62	27.82	31.35	34.62	38.02	42.02	46.50
E1		21.80	25.10	28.50	30.70	34.10	37.50	40.90	44.90	49.40
D1	Min	22.35	25.65	29.05	31.25	34.65	38.05	41.45	45.45	49.95
	Max	14.40	17.65	21.40	24.65	27.82	29.24	33.70	36.92	40.06
L1	Min	14.53	17.78	21.59	24.77	27.94	30.66	33.83	37.00	40.18
	Max	15.93	15.93	15.93	15.93	15.93	15.93	15.17	15.17	15.17
L2	Min	16.05	16.05	16.05	16.05	16.05	16.05	15.29	15.29	15.29
	Max	13.23	13.23	13.23	13.23	13.23	13.23	13.23	13.23	13.23
L3	Min	13.45	13.45	13.45	13.45	13.45	13.45	13.45	13.45	13.45
	Max	2.14	2.14	2.14	2.14	2.14	2.14	2.90	2.90	2.90
Max		2.54	2.54	2.54	2.54	2.54	2.54	3.30	3.30	3.30

* See Detail A



Receptacle type 3

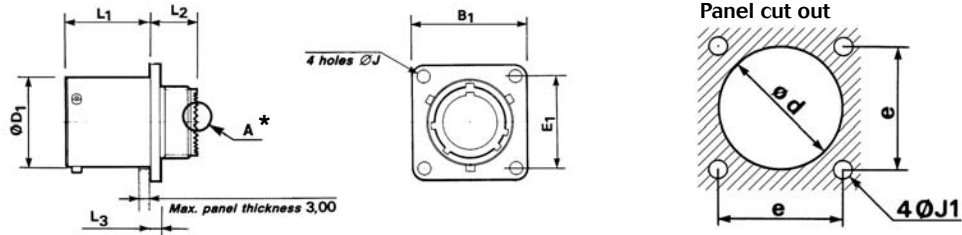

Shell size		09	11	13	15	17	19	21	23	25
B1	Min	23.70	26.05	28.50	30.85	33.20	36.40	39.55	42.75	46.00
	Max	24.30	26.70	29.05	31.45	33.80	37.00	40.15	43.35	46.50
E1		18.26	20.62	23.01	24.61	26.97	29.36	31.75	34.93	38.10
D1	Min	14.40	17.65	21.40	24.65	27.82	29.24	33.70	36.92	40.06
	Max	14.53	17.78	21.59	24.77	27.94	30.66	33.83	37.00	40.18
J	Min	3.25	3.25	3.25	3.25	3.25	3.25	3.25	3.73	3.73
	Max	3.35	3.35	3.35	3.35	3.35	3.35	3.35	3.83	3.83
L1	Min	20.71	20.71	20.71	20.71	20.71	20.71	19.96	19.96	19.96
	Max	20.83	20.83	20.83	20.83	20.83	20.83	20.08	20.08	20.08
L2	Min	10.40	10.40	10.40	10.40	10.40	10.40	11.15	11.15	11.15
	Max	11.90	11.90	11.90	11.90	11.90	11.90	12.70	12.70	12.70
L3	Min	2.14	2.14	2.14	2.14	2.14	2.14	2.90	2.90	2.90
	Max	2.54	2.54	2.54	2.54	2.54	2.54	3.30	3.30	3.30
d		16.66	20.22	23.42	26.59	30.96	32.94	36.12	39.29	42.47
J1		± 0.15	3.25	3.25	3.25	3.25	3.25	3.25	3.91	3.91
e		18.26	20.62	23.01	24.61	26.97	29.36	31.75	34.92	38.10

* See Detail A

Receptacle type 7 & HE 308 type 11

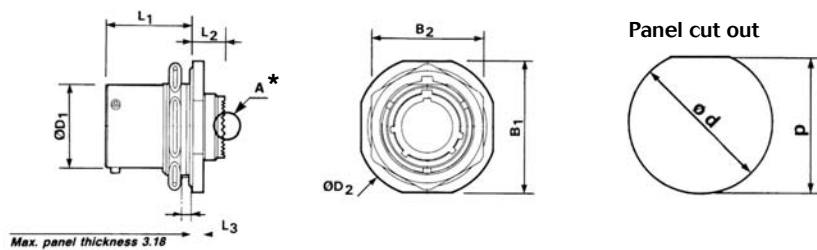

Shell size		09	11	13	15	17	19	21	23	25	
B1	Min	26.60	31.40	34.60	37.80	40.90	45.63	48.84	52.02	55.19	
	Max	27.35	32.10	35.31	38.49	41.63	46.37	49.58	52.76	55.93	
B2	Min	21.95	25.15	29.80	33.05	36.25	39.40	42.60	45.75	50.65	
	Max	22.35	25.55	30.30	33.45	36.65	39.80	43.00	46.15	50.95	
D1	Min	14.40	17.65	21.40	24.65	27.82	29.24	33.70	36.92	40.06	
	Max	14.53	17.78	21.59	24.77	27.94	30.66	33.83	37.00	40.18	
D2	Min	29.90	34.60	37.75	41.00	44.11	48.90	52.00	55.30	58.40	
	Max	30.58	35.30	38.50	41.65	44.85	49.60	52.75	55.94	59.10	
L1	Min	23.12	23.12	23.12	23.12	23.12	23.12	23.12	23.12	23.12	
	Max	23.36	23.36	23.36	23.36	23.36	23.36	23.36	23.36	23.36	
L2	Min	8.18	8.18	8.18	8.18	8.18	8.18	8.18	8.18	8.18	
	Max	8.32	8.32	8.32	8.32	8.32	8.32	8.32	8.32	8.32	
L3	Min	2.60	2.60	2.60	2.60	2.60	3.35	3.35	3.35	3.35	
	Max	3.00	3.00	3.00	3.00	3.00	3.79	3.79	3.79	3.79	
d		0/-0.25	17.78	20.96	25.65	28.83	32.00	35.18	38.35	41.53	44.70
p		0/-0.25	17.02	18.58	24.26	27.56	30.73	33.91	37.08	40.26	43.45

* See Detail A



Square flange receptacle type 2

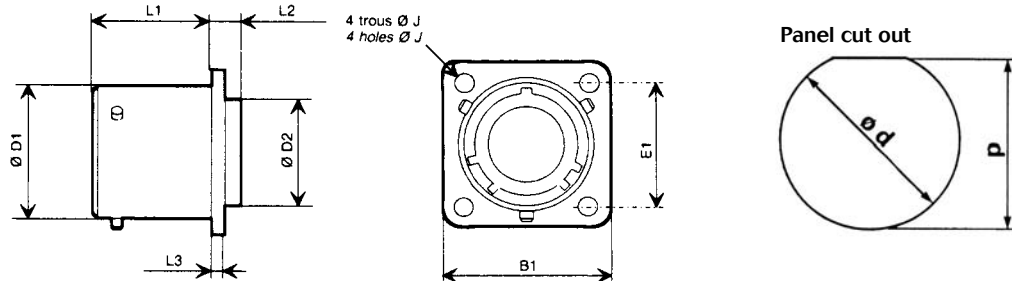

Shell size		09	11	13	15	17	19	21	23	25
B1	Min	23.70	26.05	28.50	30.85	33.20	36.40	39.55	42.75	46.00
	Max	24.30	26.70	29.05	31.45	33.80	37.00	40.15	43.35	46.50
E1		18.26	20.62	23.01	24.61	26.97	29.36	31.75	34.93	38.10
D1	Min	14.40	17.65	21.40	24.65	27.82	29.24	33.70	36.92	40.06
	Max	14.53	17.78	21.59	24.77	27.94	30.66	33.83	37.00	40.18
D2	Min	9.85	12.80	16.00	18.95	22.10	25.10	28.25	31.40	34.60
	Max	9.95	12.90	16.10	19.05	22.20	25.20	28.35	31.50	34.70
J	Min	3.25	3.25	3.25	3.25	3.25	3.25	3.25	3.73	3.73
	Max	3.35	3.35	3.35	3.35	3.35	3.35	3.35	3.83	3.83
L1	Min	20.71	20.71	20.71	20.71	20.71	20.71	19.96	19.96	19.96
	Max	20.83	20.83	20.83	20.83	20.83	20.83	20.08	20.08	20.08
L2	Min	5.40	5.40	5.40	5.40	5.40	5.40	6.15	6.15	6.15
	Max	5.55	5.55	5.55	5.55	5.55	5.55	6.35	6.35	6.35
L3	Min	2.14	2.14	2.14	2.14	2.14	2.14	2.90	2.90	2.90
	Max	2.54	2.54	2.54	2.54	2.54	2.54	3.30	3.30	3.30
d	Min	16.66	20.22	23.42	26.59	30.96	32.94	36.12	39.29	42.47
J1	± 0.15	3.25	3.25	3.25	3.25	3.25	3.25	3.25	3.91	3.91
e		18.26	20.62	23.01	24.61	26.97	29.36	31.75	34.92	38.10

Plug type 5 & type 15

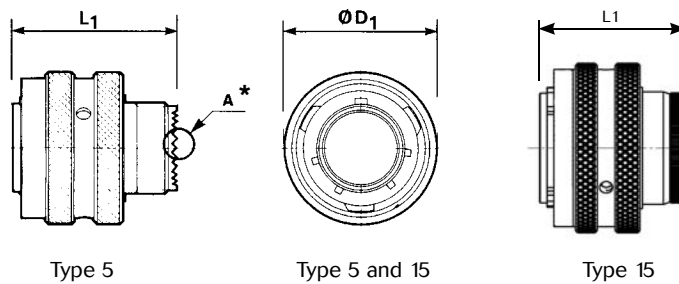

Shell size		09	11	13	15	17	19	21	23	25
D1	Min	14.35	17.70	21.50	24.65	27.85	30.55	33.75	36.90	40.10
	Max	21.80	25.00	29.30	32.50	35.70	38.50	41.70	43.85	48.00
L1	Min	31.28	31.28	31.28	31.28	31.28	31.28	31.28	31.28	31.28
	Max	31.35	31.35	31.35	31.35	31.35	31.35	31.35	31.35	31.35

* See Detail A

Dimensions in millimeters



Receptacle with straight spill contact

Receptacle type 7

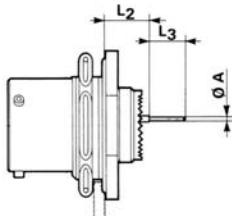

Receptacle type 0

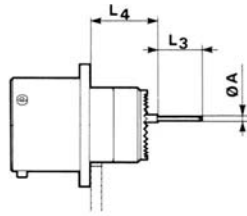

Receptacle type 3

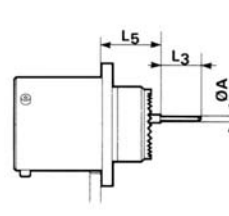

Receptacle type 2

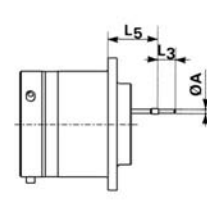

Shell Size				09	11	13	15	17	19	21	23	25		
Ø A	Contact Size	Contact Type *	Spill Contact **											
				#22D	M & F	C & L								
			S	0.70										
		M	M	0.50										
	#20	M & F	C	0.70										
	#16	M & F	C	1.15										
L3	#22D	M & F	C	4 ⁰ _{-0.20}										
			S	5 ±0.1										
			L	8.5 ⁰ _{-0.20}										
		M	M	6 ±0.1										
		#20	M & F	C	5 ±0.1									
	#16	M & F	C	5 ±0.1										
L2 type 7	8LT #22D	M	C & L	Max	10.06									
				Min	9.07									
			M	Max	10.21									
			Min	9.23										
		F	C & L	Max	10.06									
			Min	8.74										
	8LT7S HE308 #22D	M	S	Max	10.23									
				Min	9.24									
		F	S	Max	10.23									
				Min	8.91									
8LT HE308 #20 & #16	M & F	C	Max	10.23										
			Min	9.24										
L4 type 0	#22D	M	C & L	Max	15.08									
				Min	13.91									
			M	Max	15.22									
			Min	14.05										
			F	C & L	Max	15.08								
			Min	13.58										
		M	S	Max	15.25							15.25		
			Min	14.08										14.08
		F	S	Max	15.25								15.25	
			Min	13.75										13.75
	#20 & #16	M & F	C	Max	15.25									
			Min	14.08										
L5 type 2 type 3	#22D	M	C & L	Max	12.47							13.22		
				Min	11.60							12.35		
		F	C & L	Max	12.47							13.22		
				Min	11.27							12.02		
	M	S	Max	12.64				12.64			13.39			
			Min	11.77				11.77			12.52			
	F	S	Max	12.64				12.64			13.39			
			Min	11.44				11.44			12.19			
	#20 & #16	M & F	C	Max	12.64							13.39		
				Min	11.77							12.52		

* M: Male Contact, F: Female Contact

** C: Short Spill, M: Medium Spill, L: Long Spill, S: Specific Spill



Receptacle type 7 with wire wrap contacts

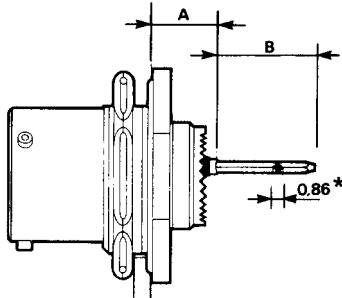

Contact size	Contact type	A	B Max
#22D	W 3 wraps	9.07 to 10.06	16.00
#20	T 2 wraps	9.7 to 10.06	12.60

* See «Wire Wrap Contacts» table

Detail A

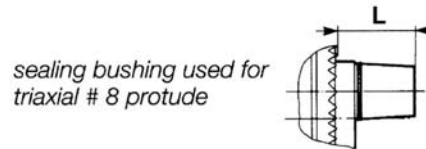

Shell Type	Type 0	Type 1	Type 3	Type 5	Type 7
L max	13.39	13.58	13.58	13.54	13.58



8LT Series

SOURIAU Rack and Panel connectors part numbers

Basic series	8 LT	27	-	15	B	35	P	N	-	-	L
Shell type	<ul style="list-style-type: none"> 27: Receptacle for rack, for male contacts, with possibility to mount rear accessory 23: Square flange receptacle (consult us) 26: Floating plug for rack, for crimp female contacts, with possibility to mount rear accessory 										
Type	<ul style="list-style-type: none"> None: Connector with standard crimp contacts Q: Connector with quadrax crimp contacts C: Connector with short spill (male and female #20, #16, #12, #8 quadrax) S: Connector with specific straight spill (male and female #22D only) L: Connector with long spill (male and female #22D) 										
Shell size:	11, 13, 15, 17, 19, 21, 23, 25										
Plating	<ul style="list-style-type: none"> F: Nickel B: Olive green cadmium 										
Contact layout:	See tables «Contact Layouts»										
Contact type	<ul style="list-style-type: none"> P: Male S: Female 										
Polarization:	N										
Specification	<ul style="list-style-type: none"> None: Supplied with contacts 251: Connector provided with power contacts (for layout with cavities #8) *284: Quadrax grounded (cts 100Ω) 308: Quadrax not grounded (cts 100Ω) *384: Quadrax grounded (cts 150Ω) 408: Quadrax not grounded (cts 150Ω) 										
Special custom	<ul style="list-style-type: none"> None: Standard plastic cap M: Antistatic plastic cap 										
L:	Connector supplied without contacts										

*Excepted mixed layouts with quadrax and signal contacts. Please consult us.

HE 308 Rack and Panel connectors part numbers

Basic series	HE308	26	T	23	01	P	N	7	M	-	-
Shell type	<ul style="list-style-type: none"> 26: Floating plug for rack, for crimp female contacts, with possibility to mount rear accessory 27: Receptacle for rack, for male contacts, with possibility to mount rear accessory 21: Receptacle for rack with straight spill contacts 										
Class	T: Sealed										
Shell size:	11, 13, 15, 17, 19, 21, 23										
Contact layout:	See tables «Contact Layouts»										
Contact type	<ul style="list-style-type: none"> P: Male S: Female 										
Polarization:	N										
Plating	7: Olive green cadmium										
Contractual specifications	M: DAT quality insurance										
Special custom	<ul style="list-style-type: none"> None: Standard plastic cap M: Antistatic plastic cap 										
Specifications	<ul style="list-style-type: none"> None: Connector supplied with contact L: Connector supplied without contact 										



Rack & Panel, features and benefits

- Signal and Power connector
- Easy and fast connection without any coupling/uncoupling between a float-mounting unit and a fixed unit.
- 100% scoop proof
- Plug misalignment allowed
- Rear accessories available
- 8 shell sizes available: from 11 to 23 with DTAT-C5935-X0005 layout - including power contact cavities
- Sealing as per HE 308
- EMI performances as per DTAT-C5935-X0005

Shell Size	Mated Force (daN)	Unmated Force (daN)
11	20	12
13	30	13
15	35	15
17	50	16
19	55	18
21	65	22
23	80	27
25 *	-	-

* Please consult us

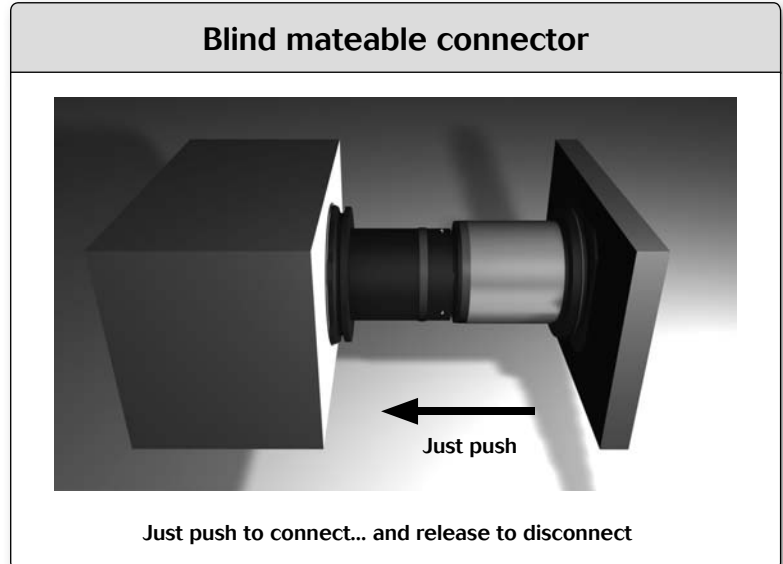

Superior misalignment allowances

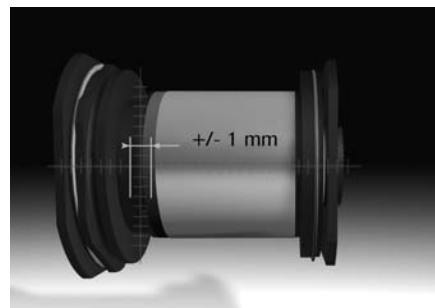
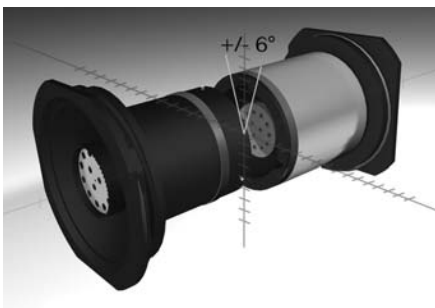
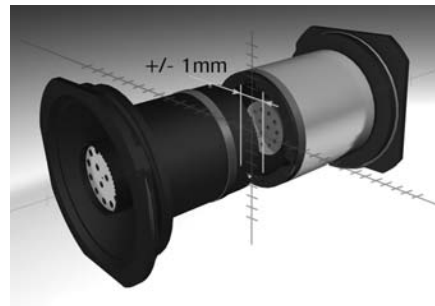
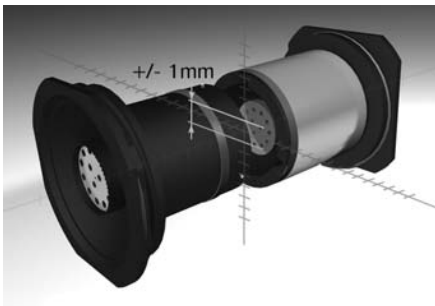



Rack & Panel, dimensions

Equipment receptacle (type 27)

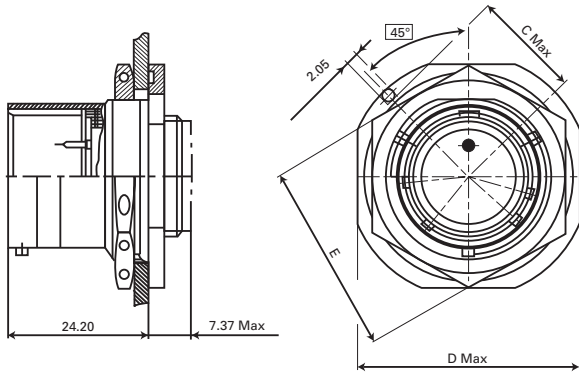

Shells	11	13	15	17	19	21	23	25
C Max	15.33	16.92	18.51	20.10	22.67	24.26	25.84	27.43
D Max	32.16	35.34	38.51	41.69	46.43	49.64	52.78	56.00
E	25.55	30.30	33.45	36.65	39.80	43	46.15	50.95

Rack plug (type 26)

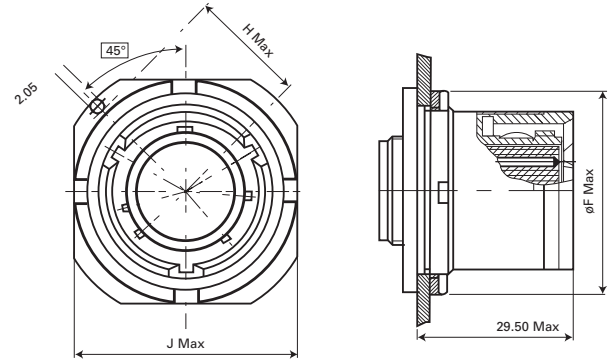

Shells	11	13	15	17	19	21	23	25
ØF Max	32.10	35.25	38.40	41.60	46.30	49.60	52.70	55.90
H Max	16.92	18.51	20.10	22.67	24.26	25.84	27.43	29.03
J Max	32.16	35.34	38.51	41.69	46.43	49.64	52.78	55.96

Square flange receptacle (type 23)

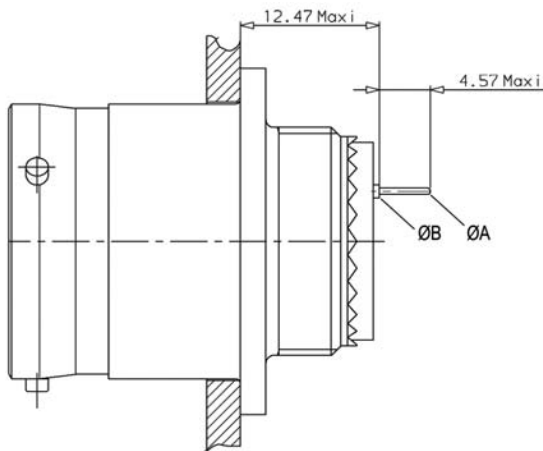

Contact size	#22D	#20	#16
A	0.5	0.7	1.15
B	1	1.5	2.2

Mated connectors plug (type 26) and receptacle (type 27)

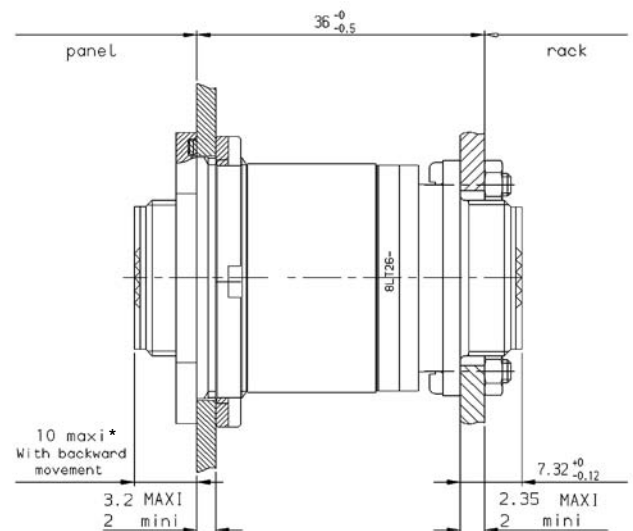

*Included longitudinal alignment



Rack & Panel, panel cut

Plug panel cut

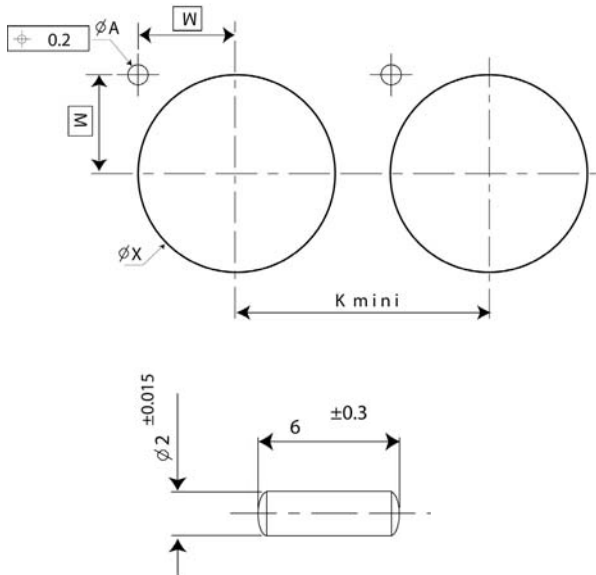

Shell size	Plug			
	W	$\text{Ø } X^{+0.1}$	K mini	$\text{Ø } A$
11	12.81	25.58	32.57	$\text{Ø } 2^{0.005}$
13	13.94	28.80	36	
15	15.06	31.98	39.60	
17	16.88	35.15	43.30	
19	18	38.28	47	
21	19.12	41.50	50.60	
23	20.24	44.68	54.20	
25	21.38	47.85	57.45	

Receptacle panel cut

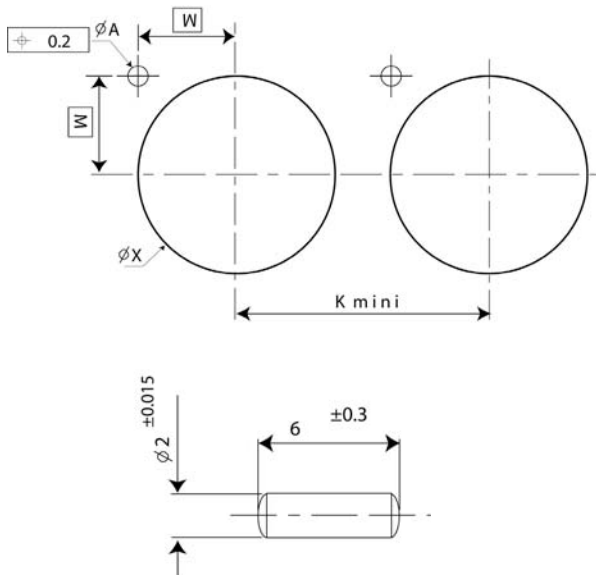





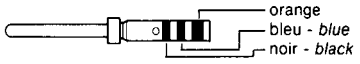
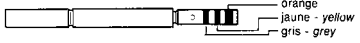

Shell size	Plug			
	W	$\text{Ø } X^{+0.1}$	K mini	$\text{Ø } A$
09	10	17.70	27.80	$\text{Ø } 2^{0.005}$
11	11.69	20.86	32.57	
13	12.81	25.58	36	
15	13.94	28.80	39.60	
17	15.06	31.98	43.30	
19	16.88	35.15	47	
21	18	38.28	50.60	
23	19.12	41.50	54.20	
25	20.24	44.68	59.70	

8LT Series

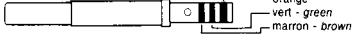

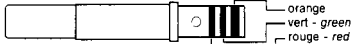
Crimp contacts

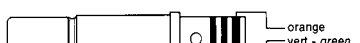
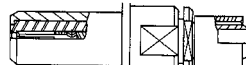
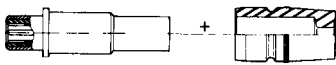
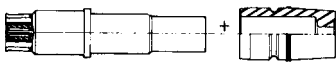
Contact size	Contact type	SOURIAU P / N (No colour code)	Contacts	
			QPL Part Numbers	Profile and colour code
#22D	Pin	8599-0702 JJ	M39029/58 360	 orange bleu - blue noir - black
	Socket	8599-0706 900	M39029/56 348	 orange jaune - yellow gris - grey
#20	Pin	8599-0703 SA	M39029/58 363	 orange bleu - blue orange
	Socket	8599-0707 900	M39029/56 351	 orange vert - green marron - brown
#16	Pin	8599-0704 MJ	M39029/58 364	 orange bleu - blue jaune - yellow
	Socket	8599-0708 900	M3929/56 352	 orange vert - green rouge - red
#16 Coaxial	Pin	N/A	M39029/76-424	-
	Socket	N/A	M39029/77-428	-
#12	Pin	8599-0705 MJ	M39029/58 365	 orange bleu - blue vert - green
	Socket	8599-0709 900	M39029/56 353	 orange vert - green orange
#8 Power*	Pin	8599-7580	N/A	-
	Socket	8599-7581	N/A	-
#8 Coaxial	Pin	N/A	M39029/60 367	
	Socket	N/A	M39029/59 366	-
#8 Triaxial	Pin	N/A	M39029/90 529	
		8599-5210 900 included boot 85904571	N/A	
#8 Triaxial	Socket	N/A	M39029/91 530	
		8599-5220 900 included boot 85904571	N/A	
#4 Power*	Pin	8599-7598 900**	N/A	For cable 25 mm ²
	Socket	8599-7599 900**	N/A	
	Pin	8599-7534	N/A	For cable 21,15 mm ²
	Socket	8599-7535	N/A	
#4 Power with reduced barrel	Pin	8599-7528 900	N/A	For cable #6
	Socket	8599-7529 900	N/A	

* See Boots & reducers table

** Not included in connector P / N. Must be ordered separately.



Technical characteristics

Contact size	Contact type	Contact \varnothing	admissible wire section				External \varnothing over insulation mm	
			AWG		mm ²			
			min	max	min	max		
#22D	Pin	0.76	28	22	0.095	0.34	0.76	1.37
	Socket							
#20	Pin	1	24	20	0.21	0.60	1.02	2.11
	Socket							
#16	Pin	1.60	20	16	0.60	1.34	1.65	2.77
	Socket							
#16 Coaxial	Mâle/Pin	1.60	RG 174 RG 179 RG 316				1.65	2.60
	Socket							
#12	Pin	2.40	14	12	1.91	3.18	2.46	3.61
	Socket							
#8 Power*	Pin	3.64		8		8.98	4.50	6.50
	Socket							
	Boot							
#8 Coaxial	Pin		RG 188 A/U					2.80
	Socket							
#8 Triaxial	Pin	5.5	MIL C 17/176.00002 FILECA F 2703/14 RAYCHEM CHEMINAX 106 12 FILOTEX M 17/176.00002				3.15	3.40
	Socket							
#4 Power*	Pin 8599-7598 900	5.74	-	(3)	-	25		-
	Socket 8599-7599 900							
	Pin 8599-7534							
	Socket 8599-7535							
#4 Power with reduced barrel	Pin	5.74	-	6	-	13.3		-
	Socket							

* See Boots & reducers table.



Reducers

Reductor Size	Part number	For cable	For contacts
#8 Power	8599-7645	#10	8599-7580 (Pin) 8599-7581 (Socket)
#4 Power	8400-2352A	10 mm ²	8599-7534A (Pin) 8599-7535A (Socket)

Boots

Boot Size	Part number	Admissible wire section mm ²		For cable
#8 Power	8599-4542	5	6.5	8.48 à 10 mm ²
	8599-4547	2.5	4	#10
#4 Power	8599-4594	6.35	7.5	#4 - #5
	8599-4593	4	5.8	#6 - #8

Straight spill contacts

Contact size	Contact type	Spill Type	Part Numbers	Profile
#22D 8LT	Male	L	8599-0720 900	
	Male	C	8599-0730 900	
	Female	L	8599-0721 900	
	Female	C	8599-0731 900	
	Male	M	8599-8028 900	-
#22D HE 308	Male	S	8599-0796 900	
	Female	S	8599-0797 900	
#20	Male	C	8599-0724 900	
	Female	C	8599-0725 900	
#16	Male	C	8599-0726 900	
	Female	C	8599-0727 900	
#12	Male	C	8599-7929 900	-
	Female	C	8599-7932 900	-

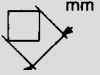
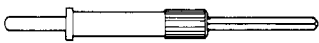
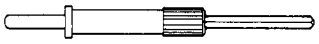

Wire wrap contacts

Contact size	Contact type	Part Numbers	Profile	Contact \varnothing mm	
#22D	Male	8599.0790 JJ		0.76	0.86
#20	Male	8599.0791 900		1	0.86

Solder cup

Contact size	Contact type	Part Numbers
#22D	Pin	8599-0750 900
#16	Pin	8599-7482A 900
#12	Socket	8599-7485A 900

For other solder cup, please consult us

Quadrax contacts #8

Part Number	Version	Contact type	Impedance
ETH1-1235A	Crimp	Pin	100 Ω
ETH1-1503A	Crimp	Pin	150 Ω
ETH1-1236A	Crimp	Socket	100 Ω
ETH1-1504A			150 Ω
ETH1-1237A	PCB mount	Pin	100 Ω
ETH1-1501A			150 Ω
ETH1-1238A	PCB mount	Socket	100 Ω
ETH1-1502A			150 Ω



Thermocouple contacts

Contact size Contact type	Contact type	Souriau part numbers	Contacts MIL DTL 38999	
			Part Numbers	Profile and color code
#22D Chromel	Male Pin	N / A	M39029/87-472	
	Female Socket	N / A	M39029/88-484	
#22D Alumel	Male Pin	N / A	M39029/87-471	
	Female Socket	N / A	M39029/88-483	
#20 Chromel	Male	8599-0749 900	8599-0949 900	
	Female	8599-0753 900	8599-0953 900	
#20 Alumel	Male	8599-0761 900	8599-0961 900	
	Female	8599-0765 900	8599-0965 900	

Technical characteristics

Contact size	cts Ø (mm)	Wire section				Ø over insulation (mm)	
		AWG		mm ²			
		Min	Max	Min	Max	Min	Max
#22D Chromel Alumel	0.76	28	22	0.095	0.34	0.76	1.37
#20 Chromel Alumel	1	24	20	0.21	0.6	1.02	2.11



Orientations

Polarization is determined by the master keyway position.
The secondary keyway positions remain fixed.

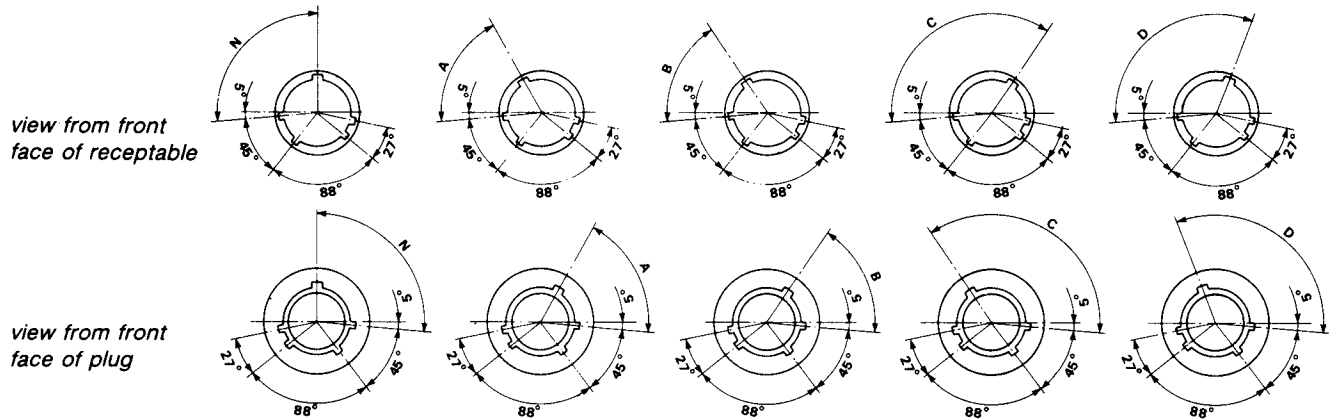

Shell size	Angles (degrees)				
	N	A	B	C	D
09	95	77	-	-	113
11	95	81	67	123	109
13	95	75	63	127	115
15	95	74	61	129	116
17	95	77	65	125	113
19	95	77	65	125	113
21	95	77	65	125	113
23	95	80	69	121	110
25	95	80	69	121	110



Accessories

Protective cap for receptacles

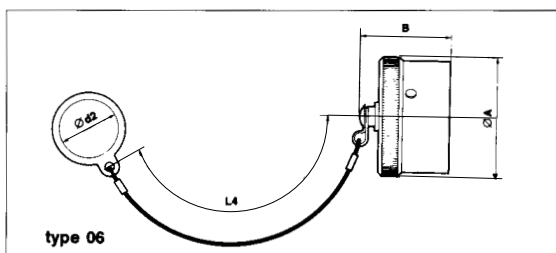
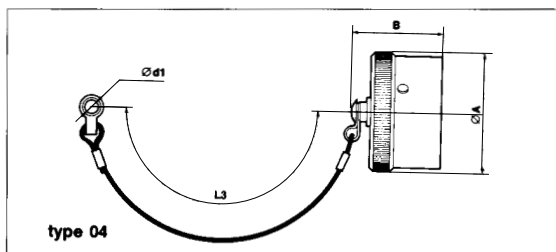
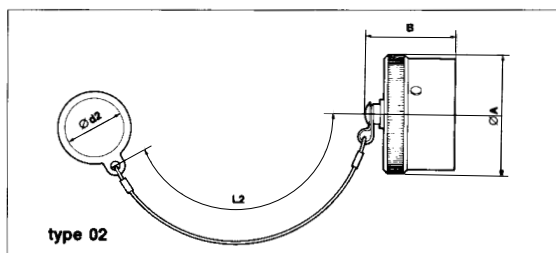
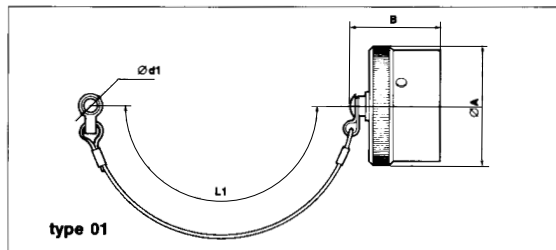

Protective cap for plugs

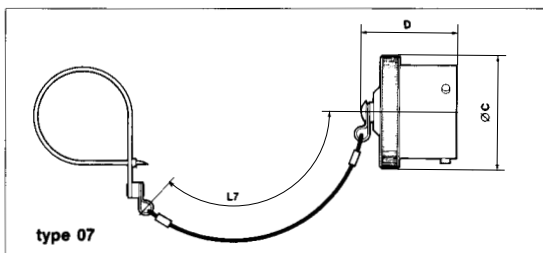
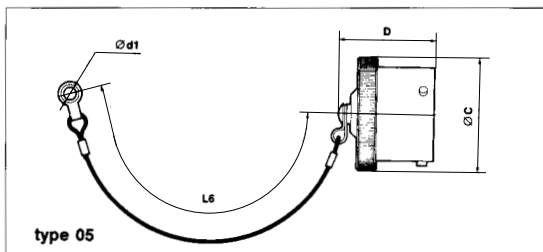
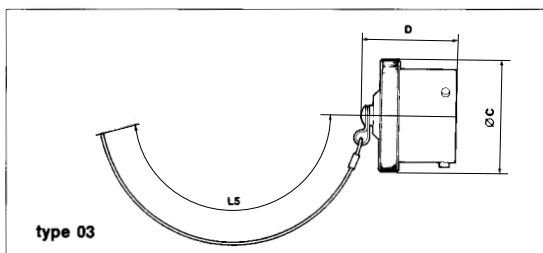
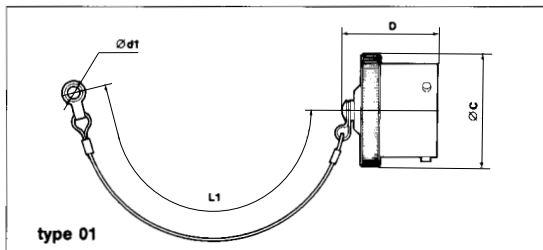

Shell size	A Max	B Max	C Max	D Max	d1 min	d2 min	L1	L2	L3 \pm 5	L4 \pm 5	L5 \pm 5	L6 \pm 5	L7 \pm 5
09	21.80	28.00	20.80	29.50	3.20	17.80	76	76	105	105	200	160	160
11	24.90	28.00	23.80	29.50	3.20	21.30	76	76	105	105	200	160	160
13	29.40	28.00	27.70	29.50	3.20	25.70	89	89	105	105	200	160	160
15	32.50	28.00	30.20	29.50	3.20	29.00	89	89	105	105	200	160	160
17	35.80	28.00	33.50	29.50	3.20	32.00	89	89	105	105	200	160	160
19	38.60	28.00	36.50	29.50	3.20	35.30	89	89	105	105	200	160	160
21	41.90	28.00	39.80	29.50	3.20	38.40	102	102	105	105	200	160	160
23	44.90	28.00	42.90	29.50	3.20	41.70	102	102	105	105	200	160	160
25	48.00	28.00	46.20	29.50	3.20	44.70	102	102	105	105	200	160	160



8LT Series

Protective caps

Basic series	8LT	E	01	B	13
Cap type					
E: Cap for receptacle					
F: Cap for plug					
Fixing type					
Cap for receptacle			Cap for plug		
01: Plastic sleeved metal card with eyelet			01: Plastic sleeved metal card with eyelet		
02: Plastic sleeved metal card with ring			03: Nylon cord without fastener		
04: Nylon cord with eyelet			05: Nylon cord with eyelet		
06: Nylon cord with ring			07: Nylon cord with strap		
10: Black nylon cord with eyelet					
Plating					
B: Olive green cadmium					
F: Nickel					
Shell size: 09 - 11 - 13 - 15 - 17 - 19 - 21 - 23 - 25					

Dummy receptacle

Shell size	Part numbers	L1 Max	L3 Max	D1 Max	B1 Max	E1	J
09	8LT0-09GUR	16.05	2.54	14.53	24.25	18.26	3.25
	8LT0-09FUR						
11	8LT0-11GUR	16.05	2.54	17.78	26.60	20.62	3.25
	8LT0-11FUR						
13	8LT0-13GUR	16.05	2.54	21.59	29.00	23.01	3.25
	8LT0-13FUR						
15	8LT0615GUR	16.05	2.54	24.77	31.35	24.61	3.25
	8LT0615FUR						
17	8LT0-17GUR	16.05	2.54	27.94	33.75	26.97	3.25
	8LT0-17FUR						
19	8LT0-19GUR	16.05	2.54	30.66	36.90	29.36	3.25
	8LT0-19FUR						
21	8LT0-21GUR	15.29	3.30	33.83	40.10	31.75	3.25
	8LT0-21FUR						
23	8LT0-23GUR	15.29	3.30	37.00	43.25	34.93	3.73
	8LT0-23FUR						
25	8LT0-25GUR	15.29	3.30	40.18	46.50	38.10	3.73
	8LT0-25FUR						

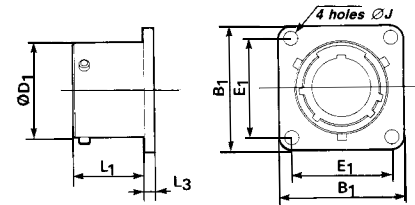

Plastic protective caps

Shell size	Part numbers for standard cap	
	Caps for receptacle	Caps for plug
09	8500-5594	70609
11	MS90376-12R	MS90376-16Y
13	8500-5588A	8500-5600
15	8500-5589A	8500-5601
17	MS90376-20yF	8500-5602
19	8500-5601	8500-5592A
21	8500-5602	8500-5593A
23	MS90376-24R	MS90376-24R
25	8500-5593A	J599ABC6009A00

Shell size	Part numbers for antistatic cap	
	Caps for receptacle	Caps for plug
09	MS90376-10RF	MS90376-14RF
11	MS90376-12RF	MS90376-16RF
13	8500-5588N	8500-5600N
15	MS90376-18yF	8500-5601N
17	MS90376-20yF	8500-5602N
19	8500-5601N	8500-5592N
21	8500-5602N	8500-5593N
23	MS90376-24RF	-
25	8500-5593N	-

8LT Series



Panel gasket

Shell size	Part numbers	
	Gasket for receptacle type 0, 2, 3 (to be ordered separately)	O ring for receptacle type 7 (shipped with connector)
09	8599-5541	AS3582-019
11	8599-5542	AS3582-022
13	8599-5543	AS3582-024
15	8599-5544	AS3582-026
17	8599-5545	AS3582-028
19	8599-5546	AS3582-128
21	8599-5547	AS3582-130
23	8599-5548	AS3582-132
25	8599-5549	AS3582-134

Tooling

Crimping (#22D, #20, #16 and #12)

Contact size	Wire sizes		Type	Pliers						
				M22520/1-01 (Souriau 8365)		M22520/2-01 (Souriau 8476-01)		M300 BT Locator P / N	M21520/23-01	
	mm ²	AWG		P / N turret		P / N locator			P / N turret	P / N locator
			Norm/Spec	Souriau	Norm/Spec	Souriau				
#22D	0.38	22	M	-	-	M22520/2-09	8476-09	-	-	-
	0.21	24	F	-	-	M22520/2-07	8476-07	-	-	-
#20	0.15	26								
	0.095	28								
#16	0.60	20	M	M22520/1-04	8365-04	M22520/2-10	8476-10	-	-	-
	0.38	22	F	M22520/1-04	8365-04	M22520/2-10	8476-10	-	-	-
#12	0.21	24								
#8 power	1.34	16	M	M22520/1-04	8365-04	-	-	-	-	-
	0.93	18	F	M22520/1-04	8365-04	-	-	-	-	-
#4 power*	0.60	20								
#8 power	3.18	12	M	M22520/1-04	8365-04	-	-	-	-	-
	1.91	14	F	M22520/1-04	8365-04	-	-	-	-	-
#8 power	8.98	8	M	-	-	-	-	SP 593	M22520/23-02	8599-9601
	max	max	F	-	-	-	-			
#4 power*	10	7	M	-	-	-	-		M22520/23-04	M22520/23-11
	16	4	F	-	-	-	-			

* Pneumatic pliers

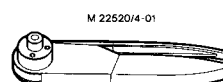
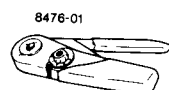
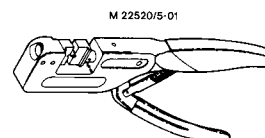
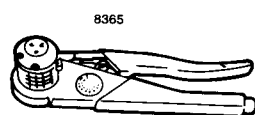



Coaxial contact #16

Contat type	Pliers	Locators
Inner contact	M22520/2-01	M22520/2-35
Outer contact	M22520/4-01	M22520/4-02

Triaxial contact #8

Contat type	Pliers	Locators
Middle contact	M22520/5-01	Y 631 closure B
Inner contact	M22520/2-01	K 709
Ferrule	M22520/5-01	Y 631 closure A

Quadrax contact #8

Outer body: M2252015-01 crimping tool and M2252015-45 dieset rep B

Signal contact: M22520/201 crimping tool and K709 positioner

Dummy contact #8

Part number
8599-0308



Dummy contact #4

Part number
8599-0310

Filler plugs

Contact size	Part Numbers		Colour
	Spec	Souriau	
#22D	MS27488-22	8660-212	Black
#20	MS27488-20	8522-389A	Red
#16	MS27488-16	8522-390A	Blue
#12	MS27488-12	8522-391A	Yellow

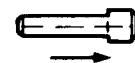

Direction of introduction
in grommet

Insertion and extraction of wired contacts

Contact size	Material	Part Numbers		Colour	
		Spec	Souriau	Insertion	Extraction
#22D	Plastic	M81969/14-01	8599-0022	Green	White
#20	Pastic	M81969/14-10	8522-20	Red	Orange
#16	Plastic	M81969/14-03	8522-16	Blue	White
#12	Plastic	M81969/14-04	8522-12	Yellow	White
#10	Plastic	M81969/14-05	-	Grey	White
#8	Metallic	-	8660-197	manual insertion	No colour
	Plastic	M81969/14-12	-		Red
#4	Metallic	-	8533-8175	-	No colour
	Plastic	M81969/14-07	-		Blue



Colored tip for insertion
White tip for extraction

8660-197

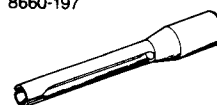



Wiring instructions

Cable preparation and wire stripping

Contact size	L (mm)
#22D	4
#20	6
#16	
#12	
#8	12
#4	



Insertion of wire in contact barrel

When inserting the stripped wire into the contact barrel check that no strands are left outside and that the wire is visible through the wire inspection hole in the barrel.

Important :

- Slide any accessories over wire strands before carrying out the following operations.
- Contacts are inserted and extracted from the rear of the connector.

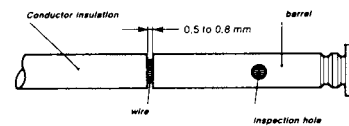

Insertion of the contacts

1 - Engage the grimp cable / contact assembly into the longitudinal slot of the plastic tool (coloured tip).

Slide the tool down the cable until the tip of the tool abuts the contact retention shoulder.

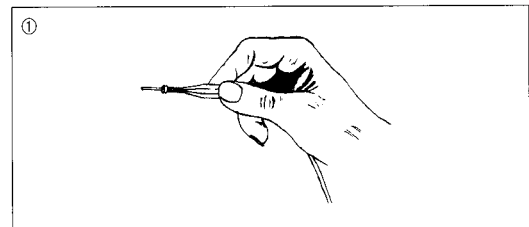

2 - Introduce the contact into the required contact cavity in the insulator, pushing tool axially, until the contact snaps into position in clip.

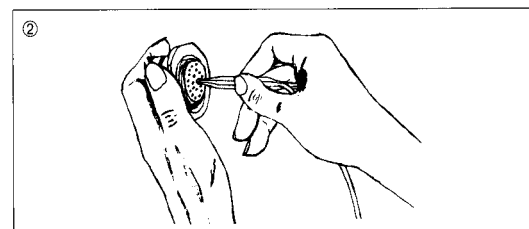

3 - Withdraw the tool (from rear). Check that contact is firmly locked by pulling wire gently. When connector is fully loaded, check the position of contact tips. They should all be in the same plane.

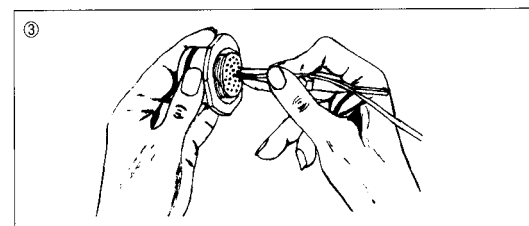

Nota : For larger sizes of cable which are stiff enough manual insertion without tool is preferable.

8STA Circular Miniature Connector Size 06-05



Extraction of the contacts

1 - Engage the appropriate cable into the longitudinal slot of the tool with the white tip towards connector.

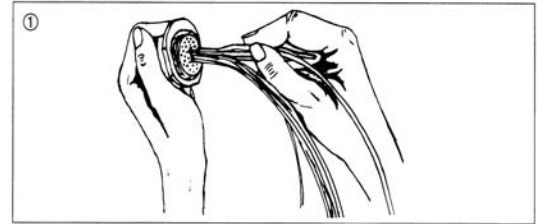

2 - Slide the tool down towards the contact. Insert the tool in the insulator until it abuts the contact shoulder.

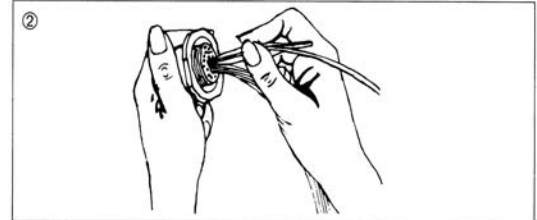

3 - Holding the tool-contact and cable assembly together, remove them simultaneously.

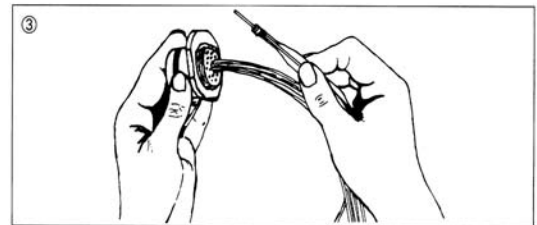

Tightening support

Part number
8599-0801

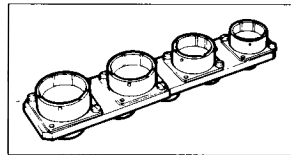

Backshell tightening and slackening tools

Backshell tightening pliers, part number : 8498-03

Square jaws, part number : 8500-1015 (order 2 jaws)

Strap clamp : 8498-04

Spare strap : 8498-103

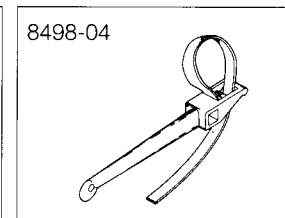
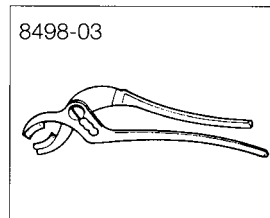

Tightening of fixing nuts, receptacle type 7

Shell size	09	11	13	15	17	19	21	23	25
Nut dimension across flats	22.35	25.55	30.30	33.45	36.65	39.80	43.00	46.10	50.95
Max tightening torque on nut (mN)	6	8	10	13	20	23	25	26	28

Tightening of rear accessories

Shell size	09	11	13	15	17	19	21	23	25
Max torque in m/daN	0.62						1.24		

8STA Circular Miniature Connector Size 06-05



Backshells

Basic type										8 LST	103	B	01	-
Shell size	09	11	13	15	17	19	21	23	25					
Index number	101	102	103	104	105	106	107	108	109					
Plating														
F: Nickel														
B: Olive green cadmium (MIL C 38999)														
Backshell type														
01: Backnut														
02: Straight cable clamp														
03: Elbow cable clamp														
07: Backshell for screen termination and heatshrink sleeving														
Suffix														
1: For backshell type 07 only - For receptacle type 0 (shells 09 to 25) and for plug type 5 (shells 09 to 23)														
None: For all other backshells														

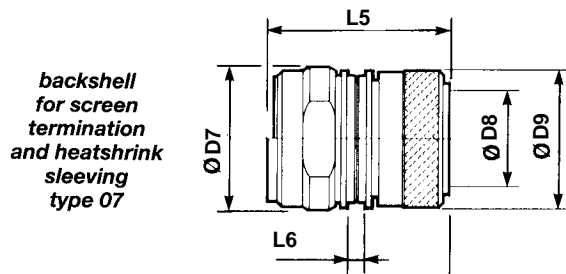

Shell size		09	11	13	15	17	19	21	23	25
D7 Max		20.20	23.20	26.20	29.20	32.20	35.20	39.20	42.20	45.20
D8	Min	6.90	9.60	12.70	14.80	17.90	19.90	23.10	26.20	28.80
	Max	7.00	9.70	12.80	14.90	18.00	20.00	23.20	26.30	28.90
D9 Max		16.00	18.90	22.10	25.30	28.50	31.50	34.70	37.90	41.00
L5 for receptacle type 0 - 3 - 1	T1	27.80	27.80	27.80	29.80	29.80	30.80	34.60	34.60	34.60
L5 Max for plug type 5	T1	27.80	27.80	27.80	29.80	29.80	30.80	34.60	34.60	-
L6 Max		3.40	3.40	3.40	3.40	3.40	3.40	3.40	3.40	3.40

8STA Circular Miniature Connector Size 06-05

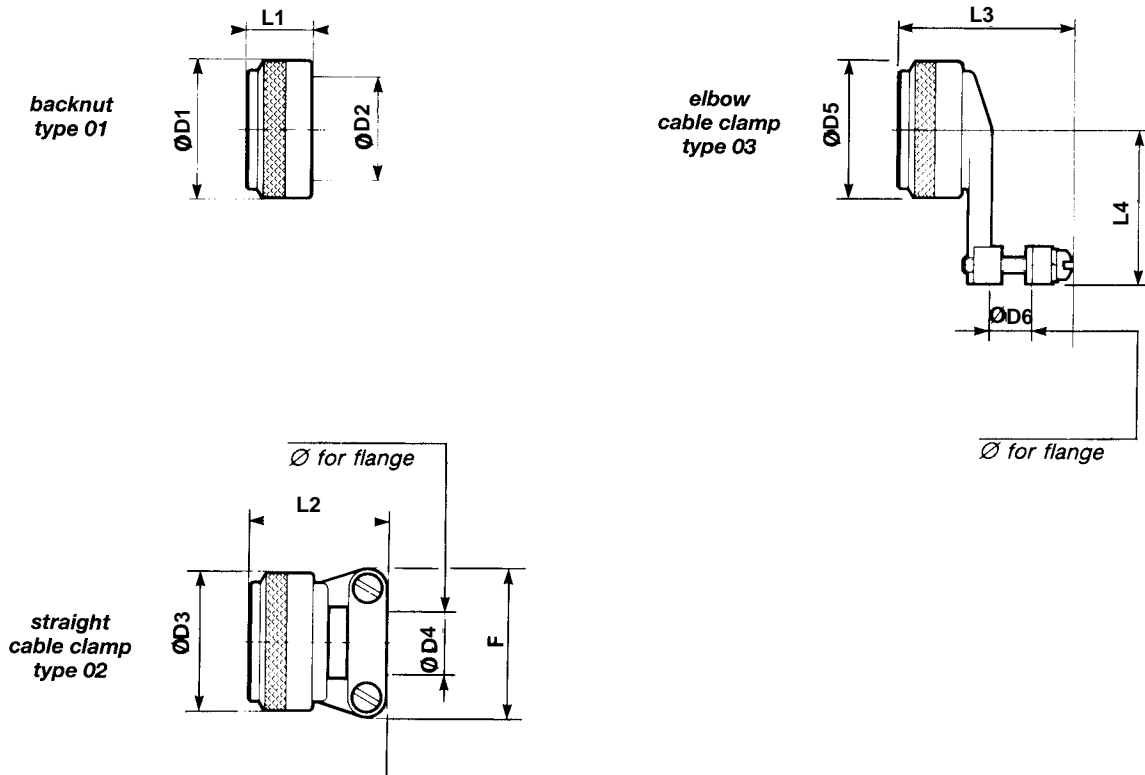

Shell size		09	11	13	15	17	19	21	23	25
D1 Max		15.67	18.64	21.79	24.99	28.24	30.94	34.16	37.29	40.46
D2 Max		6.96	10.46	13.36	16.53	19.71	22.40	25.56	28.75	31.93
L1 Max		11.30	11.30	11.30	11.30	11.30	11.30	11.30	11.30	11.30
D3 Max		15.67	18.64	21.79	24.99	28.24	30.94	34.16	37.29	40.46
D4	Min	1.40	1.40	2.40	5.60	5.60	8.80	11.90	15.10	15.10
	Max	3.20	4.80	6.40	9.50	12.70	15.90	19.10	22.20	25.40
F Max		21.03	22.63	25.81	28.98	30.56	37.31	37.31	42.06	44.45
L2 Max		22.22	22.22	22.22	28.57	28.57	28.57	28.57	31.75	31.75
L5 Max		47.22	48.02	49.52	55.92	59.42	59.42	59.42	59.42	59.42
D5 Max		15.67	18.64	21.79	24.99	28.24	30.94	34.16	37.29	40.46
D 6	Max	3.20	4.00	4.80	5.50	6.40	7.90	9.50	10.30	14.30
	Min	6.40	9.50	11.10	14.30	15.90	19.10	22.20	23.80	25.40
L3 Max		35.32	35.32	37.30	41.67	46.04	46.45	48.43	51.98	54.78
L4 Max		25.40	26.19	27.79	30.96	32.54	34.14	34.93	36.53	43.66



8STA Circular Miniature Connector Size 06-05

Cost effective & light hermetics / Resin sealed

Presentation

- Potted receptacle with male or female straight spill contacts
- 100% scoop proof: no perturbation when locking the connector, contacts never touch each other

Characteristics

- Weight saving compared to hermetic version
- Reinforced sealing for harsh environment ($10E^{-7}$ atm.cm³/s)



Comparison between standard and hermetic version

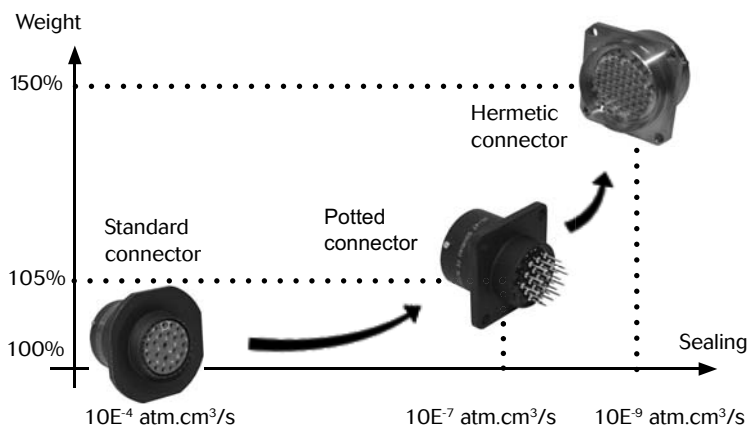

- Good shock resistance - better than hermetic glass seal
- Female contacts available for the receptacle

Contact layout

- Straight spill from #22D to #16 for all other contacts please consult us.

8STA Circular Miniature Connector Size 06-05



Souriau Part Numbers

Basic Series	8LTR	0	C	09	B	35	P	N
Shell style								
0: Square flange receptacle								
1: cable connecting receptacle								
2: Short square flange receptacle not accepting backshell								
3: Square flange receptacle (rear mounting)								
5: Plug with RFI shielding								
15 : Plug with RFI shielding not accepting backshell								
7: Jam nut receptacle								
Type								
C: Receptacle with short spill (male and female #22D, #20, #16)								
L: Connector with long spill (male and female #22D)								
S: Connector with specific straight spill (male and female #22D)								
M: Connector with average spill (male #22D)								
P: Connector with solder cup: . Pin: #22D & #16; Socket: #12 . Socket: #22D & #16; Pin: #12 - Please consult us								
Shell size: 09 - 11 - 13 - 15 - 17 - 19 - 21 - 23 - 25								
Plating								
B: Olive green cadmium								
F: Nickel								
Z: Green zinc cobalt								
L: Black zinc nickel								
Contact layouts: see tables «Contact Layouts»								
Contact type								
P: Male								
S: Female								
Orientation (1)								
N - A - B - C - D see table «Orientations»								

(1) Orientation B & C not developed for shell size number 9



8ST Series

Applications

High density connectors for all military and aeronautical purposes

Standards

JN 1003
VG 96912 - pr EN 3372
EFA J 62-017



Description

- A high density connector from 1 to 128 contacts
- Sizes 22D, 20, 16, 12, # 16 coax and # 8 triax
- Bayonet locking system
- MIL-C 38999 Series I contact layouts
- 100% scoop proof
- EMI/RFI shielding and shell-to-shell continuity

Characteristics

Mechanical

- Shell : aluminum alloy
- Plating : olive green cadmium or nickel
- Insulator : thermoplastic
- Grommet and seal : silicone elastomer
- Contact : copper alloy
- Plating : gold over nickel
- Endurance :
500 mating/unmating operations
- Shock :
300 g during 3 ms and MIL-S 901 grade A
- Vibration : 147 m/s², 10 to 2000 Hz
- Contact retention (mini force in N) :
size 22 D : 45 N size 20 : 60 N
size 16 : 100 N size 12 : 100 N
size 8 : 110 N

Electrical

- Test voltage (Vrms)

Service	sea level	at 21000 m
M	1300	800
I	1800	1000
II	2300	1000

- Contact resistance :
resistance of wire included in measurement :
size 22D : 14.6 mΩ size 16 : 3.8 mΩ
size 20 : 7.3 mΩ size 12 : 1.7 mΩ
- Insulation resistance :
≥ 5000 MΩ (at 500 Vdc)
- Contact rating :
size 22D : 5 A size 16 : 13 A
size 20 : 7.5 A size 12 : 23 A
- Shell continuity :
- nickel/cadmium olive green : ≤ 2.5 mΩ
- nickel plating : ≤ 1 mΩ
- Shielding :
70 dB at 0.01 to 100 MHz
- Triaxial contact : # 8
- Bandwidth : 0 - 20 MHz
- Voltage rating : 500 Vac maxi.
125 Vac at 21000 m
- Voltage drop :
inner and middle contact ≤ 55 mV under 1A
outer contact ≤ 75 mV under 12 A

Climatic

- Temperature range : -65°C to +175°C
- Sealing : mated connectors
differential pressure 2 bars leakage ≤ 16 cm³/hr
- Salt spray to method :
- MIL-STD 1344 method 1001
- VG 95 210, part 2 (48 hours)
- DIN IEC 68, part 2.11

Resistance to fluids

To MIL-C 38999 :
MIL-L 7808 ; MIL-L 23699 ; MIL-H 5606 ;
MIL-A 8243 ; MIL-C 25769 ; MIL-T 5624
(JP5) - hydraulic fluids

Ordering information

FCI Souriau part numbers

basic series	8ST 5 - 10 G 35 P N **									
style	0 - square flange receptacle 1 - in line receptacle 2 - square flange receptacle, not accepting backshells 5 - plug with RFI/EMI shielding 6 - plug without RFI/EMI shielding 7 - jam nut receptacle (for single hole mounting)									
type	- - connectors with standard crimp contacts M - for receptacles with medium spill contacts C - for receptacles with short spill contacts L - for receptacles with long spill contacts									
shell size	08-10-12-14-16-18-20-22-24									
plating	G - olive green cadmium F - nickel									
contact layout	- see table p 76 to 79									
contact type	P - pin (500 mating/unmating) A - connectors supplied without pin contacts S - socket (500 mating/unmating) B - connectors supplied without socket contacts H - pin (1500 mating/unmating) J - socket (1500 mating/unmating)									
orientation	N-A-B-C-D									
specification	034 to be in accordance with JN1003 correspondance									

8ST Series



PAN 6433-2 part numbers

basic series	JN 1003	B	14-	35	P	N	1**
shell type	<ul style="list-style-type: none"> A - jam nut receptacle B - square flange receptacle FG - plug with RFI/EMI shielding H - square flange receptacle, not accepting backshells 						
shell size	08 to 24						
contact layout	- see table p 76 to 79						
contact type	<ul style="list-style-type: none"> P - pin S - socket 						
orientation	N-A-B-C-D						
specifications:	<ul style="list-style-type: none"> no suffix : no contact supplied (for crimp version) 1 : supplied with contact (for crimp version) 101 : short & gold spill contacts 102 : medium gold spill contacts 103 : long gold spill contacts 						

VG 96 912 part numbers

basic series	VG 96 912	D	10	-	35	P	N
shell type	<ul style="list-style-type: none"> A - square flange receptacle (for front or rear mounting) D - plug with RFI/EMI shielding E - plug without RFI/EMI shielding B - jam nut receptacle (for single hole mounting) 						
shell size	08-10-12-14-16-18-20-22-24						
finish	- drab olive cadmium only						
contact layout	- see table p 76 to 79						
type of contact	<ul style="list-style-type: none"> P - pin S - socket 						
polarization	N-A-B-C-D - see table p 113						

Cross reference list

Shell style	Souriau P/N	JN 1003	VG 96 912	EN 3272
Plug	8ST6**G**P/Sx	-	VG96912E****P/SN	-
Plug RFI/EMI	8ST5**G**P/SX	JN1003FG****P/S	VG96912D****P/SN	EN3372W6**N**MFx
Square flange receptacle	8ST0**G**P/Sx	JN1003B****P/S	VG96912A****P/SN	EN3372W0**N**MFx
Jam nut receptacle	8ST7**G**P/Sx	JN1003A****P/S	VG96912B****P/SN	EN3372W7**N**MFx
Cable connecting receptacle	8ST1**G**P/Sx	-	-	-
Straight endbell Cable clamp	8ST2**G**P/Sx	JN1003H****P/S	-	-
Endbell for Shielding braids	8LST****G52 VG96912L	- -	VG96912G1 VG96912L**	Separate EN-Norm

*Note : please consult us. Our product will be evaluated against the final drafts/standards when available.



8ST Series

Cross reference list

Shell styles	Souriau P/N	VG 96 912	EN 3372 *
Pin contact Crimp # 22D # 20 # 16 # 12	8599-0702 8599-0703 8599-0704 8599-0705	VG96912-P-22D VG96912-P-20 VG96912-P-16 VG96912-P-12	Separate EN-Norm
Socket contact Crimp # 22D # 20 # 16 # 12	8599-0706 8599-0707 8599-0708 8599-0709	VG96912-S-22D VG96912-S-20 VG96912-S-16 VG96912-S-12	Separate EN-Norm
Filler plug # 22D # 20 # 16 # 12	8660-212 8522-389A 8522-390A 8522-391A	DIN65194-22D DIN65194-20 DIN65194-16 DIN65194-12	Separate EN-Norm

*Note : please consult us. Our product will be evaluated against the final drafts/standards when available.

Shell styles

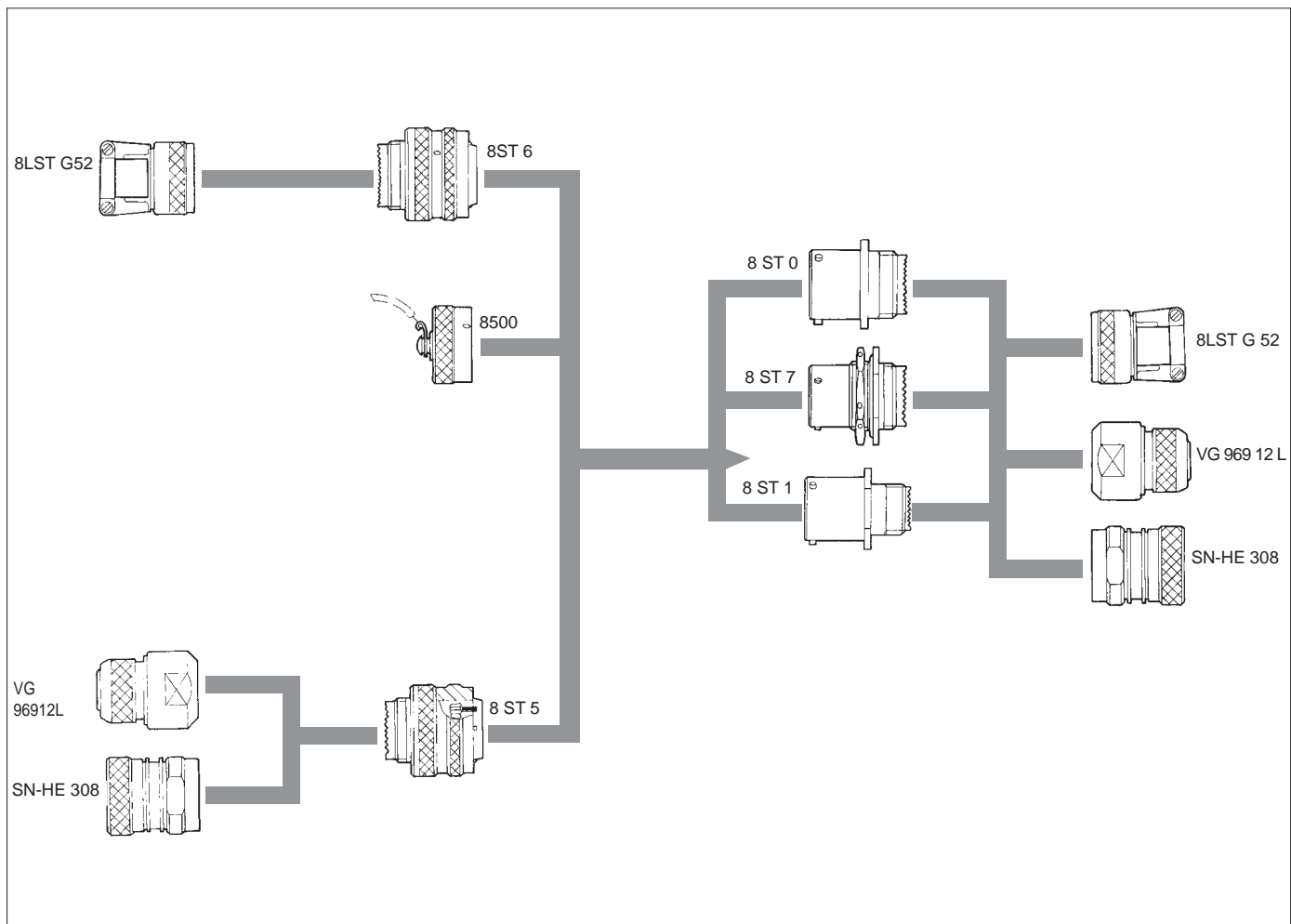



Contacts with straight spill

receptacle type 7	shell style	contact size	contact - type	contact - P/N	L1	L2 min. max.	D1
	8ST7	22 D	Short spill male	8599-0779 900	12.82-14	14.81-15.80	0.65 - $0_{,1}$
		22 D	Short spill female	8599-0788 900	12.82-14	14.81-15.80	0.65 - $0_{,1}$
		22 D	Medium spill male	8599-0728 900	15.09-16.28	13.88-14.87	0.65 - $0_{,1}$
		20	Short spill male	8599-0780 900	14.09-15.28	14.81-15.80	0.65 - $0_{,1}$
		20	Short spill female	8599-0789 900	14.09-15.28	14.81-15.80	0.65 - $0_{,1}$
		20	Medium spill male	8599-0786 900	-	14.88-14.87	0.65 - $0_{,1}$
		16	Short spill male	8599-7711 900	14.09-15.28	14.81-15.80	1.15 - $0_{,05}$
	16	Short spill female	8599-7710 900	14.09-15.28	14.81-15.80	1.15 - $0_{,05}$	
	8STO	22 D	Short spill male	8599-0730 900	17.80-19.03	14.10-15.09	0.70 - $0_{,05}$
		22 D	Short spill female	8599-0731 900	17.80-19.03	13.77-15.09	0.70 - $0_{,05}$
		22 D	Long spill male	8599-0720 900	22.30-23.53	14.10-15.09	0.70 - $0_{,05}$
		22 D	Long spill female	8599-0721 900	22.30-23.53	13.77-15.80	0.70 - $0_{,05}$
		20	Short spill male	8599-0724 900	19.07-20.30	14.27-15.26	0.70 - $0_{,05}$
		20	Short spill female	8599-0725 900	19.07-20.30	14.27-15.26	0.70 - $0_{,05}$
16		Short spill male	8599-0726 900	19.07-20.30	14.27-15.26	1.15 - $0_{,05}$	
16	Short spill female	8599-0727 900	19.07-20.30	14.27-15.26	1.15 - $0_{,05}$		

Note : please ask for separate installation instructions with contact co-ordinates.

Polarization

	shell size	N	A	B	C	D
	viewed from face of plug	08	95 °	77 °	-	-
10		95 °	81 °	67 °	123 °	109 °
12		95 °	75 °	63 °	127 °	116 °
14		95 °	74 °	61 °	129 °	116 °
16		95 °	77 °	65 °	125 °	113 °
18		95 °	77 °	65 °	125 °	113 °
20		95 °	77 °	65 °	125 °	113 °
22		95 °	80 °	69 °	121 °	110 °
24		95 °	80 °	69 °	121 °	110 °

Dimensions : plugs type 5 and type 6

	shell size	L1	d1	thread J UNEF 2A
	Detail A: - Dimensions for triaxial contacts only, please consult us ! note : this internal detail only applies to plug type 5 (version with grounding fingers)	08	32.00 1.26	18.99 .748
10		32.00 1.26	21.99 .866	9/26-24
12		32.00 1.26	25.99 1.023	11 /16-24
14		32.00 1.26	29 1.14	13/16-20
16		32.00 1.26	32.99 1.299	15/16-20
18		32.00 1.26	35.99 1.417	1" 1/16-18
20		32.00 1.26	38.99 1.535	1" 3/16-18
22		32.00 1.26	44 1.73	1" 5/16-18
24		32.00 1.26	46 1.81	1" 7/16-18



8ST Series

Square flange receptacle type 0

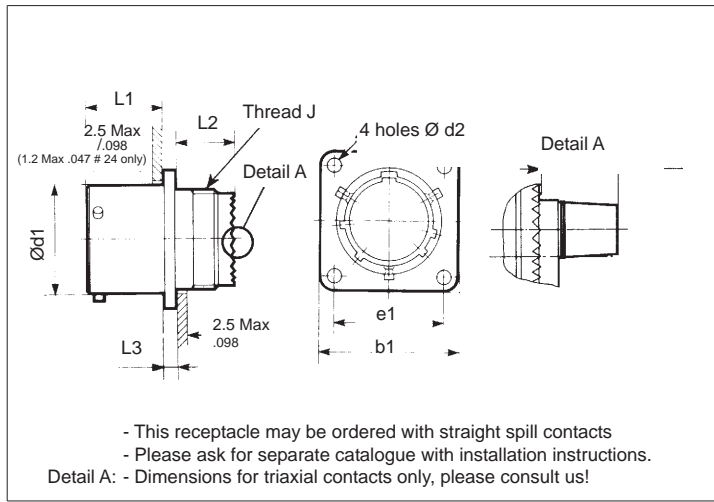

shell size	L1	L2	L3	d1	b1	d2	e1	thread J UNEF 2A
08	16.05 .632	12.25 .482	2.30 .091	12.04 .474	21.00 .827	3.05 .120	15.10 .594	7/16-18
10	16.05 .632	12.25 .482	2.30 .091	15.02 .591	24.20 .953	3.05 .120	18.30 .720	9/16-24
12	16.05 .632	12.25 .482	2.30 .091	19.08 .751	26.60 1.047	3.05 .120	20.60 .811	11 /16-24
14	16.05 .632	12.25 .482	2.30 .091	22.26 .876	29.00 1.142	3.05 .120	23.00 .906	13/16-20
16	16.05 .632	12.25 .482	2.30 .091	25.43 1.001	31.40 1.236	3.05 .120	24.60 .969	15/16-20
18	16.05 .632	12.25 .482	2.30 .091	28.61 1.126	33.70 1.327	3.05 .120	27.00 1.063	1" 1/16-18
20	15.29 .602	12.25 .482	3.06 .120	31.78 1.251	36.90 1.453	3.05 .120	29.40 1.157	1" 3/16-18
22	15.29 .602	12.25 .482	3.06 .120	34.96 1.376	40.10 1.579	3.05 .120	31.80 1.252	1" 5/16-18
24	15.29 .602	12.25 .482	3.06 .120	38.13 1.501	43.30 1.705	3.73 .147	34.90 1.374	1" 7/16-18

Jam nut receptacle type 7

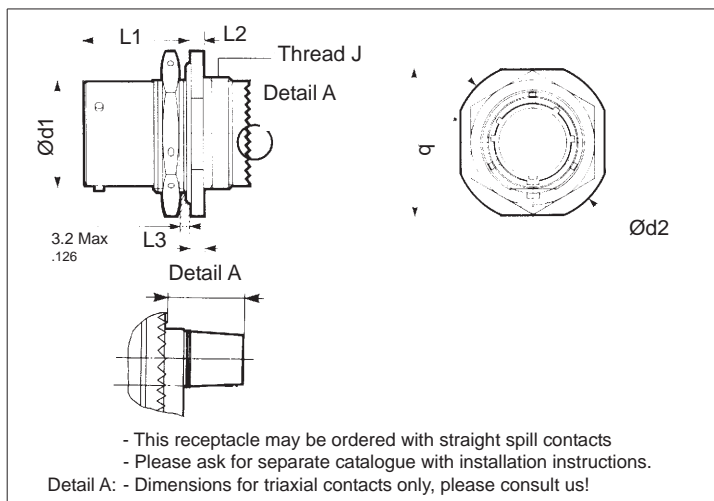

shell size	L1	L2	L3	d1	d2	b	thread J UNEF 2A
08	23.36 .920	9.86 .388	2.86 .113	12.04 .474	27.30 1.075	24.10 .949	9/16-24
10	23.36 .920	9.86 .388	2.86 .113	15.02 .591	30.50 1.201	27.30 1.075	11 /16-24
12	23.36 .920	9.86 .388	2.86 .113	19.08 .751	35.30 1.39	32.10 1.264	13/16-20
14	23.36 .920	9.86 .388	2.86 .113	22.26 .876	38.40 1.512	35.20 1.386	15/16-20
16	23.36 .920	9.86 .388	2.86 .113	25.43 1.001	41.60 1.638	38.40 1.512	1" 1/16-18
18	23.36 .920	9.86 .388	3.66 .144	28.61 1.126	44.80 1.764	41.60 1.638	1" 3/16-18
20	23.36 .920	9.86 .388	3.66 .144	31.78 1.251	49.60 1.953	46.30 1.823	1" 5/16-18
22	23.36 .920	9.86 .388	3.66 .144	34.96 1.376	52.70 2.075	49.50 1.949	1" 7/16-18
24	23.36 .920	9.86 .388	3.66 .144	38.13 1.501	55.90 2.200	52.70 2.075	1" 7/16-18

Cable connecting receptacle type 1

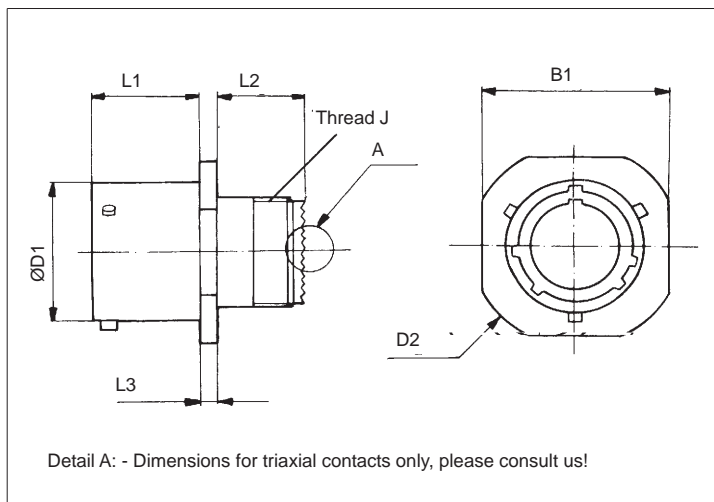

shell size	L1 Max	L2 Max	L3 Max	D1 Max	B1 Max	D2 Max	UNEF 2A thread J
08	16.05 .632	12.25 .482	2.30 .091	12.04 .474	14.63 .576	18.05 .711	7/16-24
10	16.05 .632	12.25 .482	2.30 .091	15.02 .591	18.93 .745	22.35 .880	9/16-24
12	16.05 .632	12.25 .482	2.30 .091	19.08 .751	22.23 .875	25.65 1.010	11 /16-24
14	16.05 .632	12.25 .482	2.30 .091	22.26 .876	25.63 1.009	29.05 1.144	13/16-20
16	16.05 .632	12.25 .482	2.30 .091	25.43 1.001	27.83 1.096	31.25 1.230	15/16-20
18	16.05 .632	12.25 .482	2.30 .091	28.61 1.126	31.36 1.235	34.65 1.364	1" 1/16-18
20	15.29 .602	12.25 .482	3.06 .120	31.78 1.251	34.63 1.363	38.05 1.498	1" 3/16-18
22	15.29 .602	12.25 .482	3.06 .120	34.96 1.376	38.03 1.497	41.45 1.632	1" 5/16-18
24	15.29 .602	13.65 .537	3.06 .120	38.13 1.501	42.03 1.655	45.45 1.789	1" 7/16-18

8ST Series



Through-bulkhead receptacle

Part numbers

basic series	SN1863	22	G	••	PS	N
shell size	08 to 24					
plating	G - olive green cadmium					
contact layout	please consult us					
contact type	male / female					
polarization	N - normal					

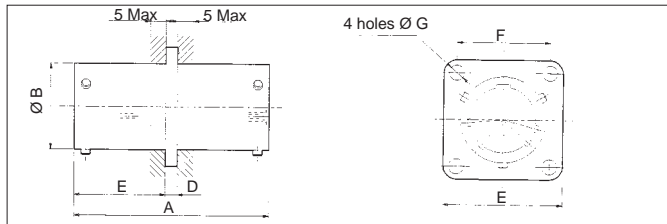

shell size	A Max	B Max	C Max	D Max	E Max	F	G Max
08	43.00 1.693	11.97 .471	20.20 .795	2.54 .100	20.97 .826	15.10 .594	3.24 .128
10	43.00 1.693	14.94 .588	20.20 .795	2.54 .100	24.18 .952	18.26 .719	3.24 .128
12	43.00 1.693	19.01 .748	20.20 .795	2.54 .100	26.56 1.046	20.62 .812	3.24 .128
14	43.00 1.693	22.18 .873	20.20 .795	2.54 .100	28.95 1.140	23.01 .906	3.24 .128
16	43.00 1.693	25.36 .998	20.20 .795	2.54 .100	31.31 1.233	24.61 .969	3.24 .128
18	45.00 1.772	28.53 1.123	20.80 .819	3.30 .130	33.67 1.326	26.97 1.062	3.24 .128
20	45.00 1.772	31.74 1.250	20.80 .819	3.30 .130	36.87 1.452	29.36 1.156	3.24 .128
22	45.00 1.772	34.88 1.373	20.80 .819	3.30 .130	40.05 1.577	31.75 1.250	3.24 .128
24	45.00 1.772	38.06 1.498	20.80 .819	3.30 .130	43.22 1.702	34.93 1.375	3.87 .152

Backshells

Backshell with cable clamp

shell size	reference	thread J UNEF-2B	E		D		B
			min	Max	Max	nom.	
08		7/16-28	1.58 .062	14.70 .579	3.18 .125	19.20 .756	15.70 .618
10	8LST 102 B52	9/16-24	1.58 .062	15.50 .610	4.78 .188	19.20 .756	18.60 .732
12	8LST 103 B52	11/16-24	3.18 .125	17.10 .673	6.35 .250	23.90 .941	21.80 .858
14	8LST 104 B52	13/16-20	6.35 .250	23.30 .917	9.53 .375	25.90 1.020	25.00 .984
16	8LST 105 B52	15/16-20	6.35 .250	26.80 1.055	12.70 .500	28.70 1.130	28.20 1.110
18	8LST 106 B52	1" 1/16-18	9.53 .375	26.80 1.055	15.88 .625	30.30 1.193	30.40 1.197
20	8LST 107 B52	1" 3/16-18	12.70 .500	26.80 1.055	19.05 .750	33.50 1.319	33.60 1.323
22	8LST 108 B52	1" 5/16-18	15.88 .625	26.80 1.055	22.23 .875	36.50 1.437	36.80 1.449
24	8LST 109 B52	1" 7/16-18	15.88 .625	26.80 1.055	25.40 1.000	39.80 1.567	40.00 1.575

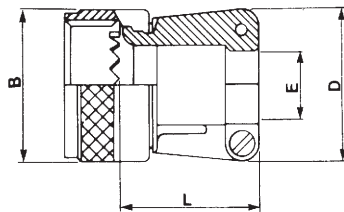

Backshell for shielded cables and heatshrink boot

shell size	reference (cadmium olive)	thread J UNEF-2B	L1 Max	L2	d4	d5	d6	d7	P	L3 Max
08	VG96912 L 08	7/16-18	24.80 .976	34.00 1.339	12.00 .472	18.20 .717	6.20 .244	14.50 .571	16.00 .630	10.50 .413
10	VG96912 L 10	9/16-24	25.80 1.016	35.00 1.378	14.00 .551	21.20 .835	7.00 .276	16.50 .650	19.00 .748	10.50 .413
12	VG96912 L 12	11/16-24	25.80 1.016	35.00 1.378	16.00 .630	24.20 .953	9.50 .374	18.50 .728	22.00 .866	10.50 .413
14	VG96912 L 14	13/16-20	25.80 1.016	35.00 1.378	20.00 .787	27.20 1.071	12.50 .492	22.50 .886	25.00 .984	10.50 .413
16	VG96912 L 16	15/16-20	26.80 1.055	36.00 1.417	23.00 .906	30.20 1.189	15.50 .610	25.50 1.004	28.00 1.102	10.50 .413
18	VG96912 L 18	1" 1/16-18	26.80 1.055	36.00 1.417	24.50 .965	34.20 1.346	18.50 .728	28.50 1.122	32.00 1.260	10.50 .413
20	VG96912 L 20	1" 3/16-18	26.80 1.055	36.00 1.417	28.50 1.122	38.20 1.504	21.50 .846	32.50 1.280	36.00 1.417	10.50 .413
22	VG96912 L22	1" 5/16-18	26.80 1.055	36.00 1.417	30.50 1.201	40.20 1.583	23.50 .925	34.50 1.358	41.00 1.614	10.50 .413
24	VG96912 L24	1" 7/16-18	26.80 1.055	36.00 1.417	34.50 1.358	45.20 1.780	27.50 1.083	38.50 1.516	43.00 1.693	10.50 .413

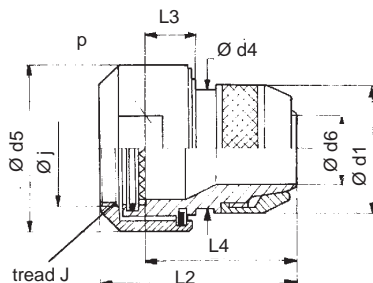

8ST Series



Accessories

Protective caps for receptacles styles 0, 1 and 7

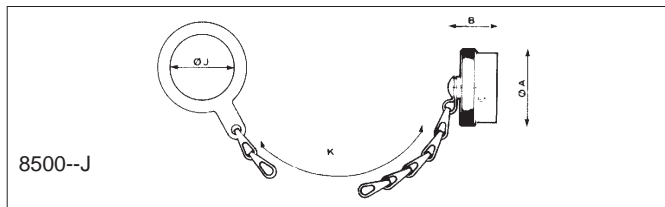
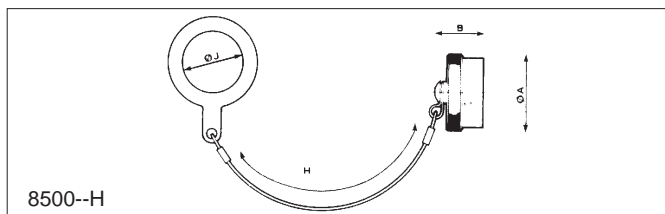
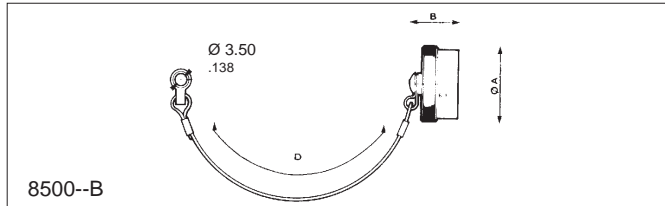
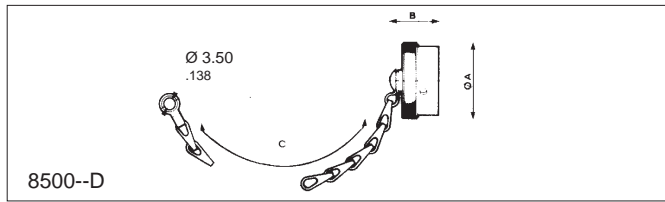

shell size	part number	A Max	B Max	C	D	J Max	H	K
08	8500 02 . . . *	19.00 .748	21.44 .844	84.00 3.307	77.00 3.031	14.80 .583	80.00 3.150	84.00 3.307
10	8500 03 . . . *	21.80 .858	21.44 .844	84.00 3.307	77.00 3.031	17.90 .705	80.00 3.150	84.00 3.307
12	8500 04 . . . *	26.10 1.028	21.44 .844	100.00 3.937	89.00 3.504	22.70 .894	90.00 3.543	100.00 3.937
14	8500 05 . . . *	29.30 1.154	21.44 .844	100.00 3.937	89.00 3.504	25.90 1.020	90.00 3.543	100.00 3.937
16	8500 27 . . . *	32.50 1.280	21.44 .844	100.00 3.937	89.00 3.504	29.00 1.142	90.00 3.543	100.00 3.937
18	8500 06 . . . *	35.30 1.390	21.44 .844	100.00 3.937	89.00 3.504	32.30 1.272	90.00 3.543	100.00 3.937
20	8500 07 . . . *	38.80 1.528	21.44 .844	116.00 4.567	102.00 4.016	35.40 1.394	110.00 4.331	116.00 4.567
22	8500 08 . . . *	42.00 1.654	21.44 .844	116.00 4.567	102.00 4.016	38.60 1.520	110.00 4.331	116.00 4.567
24	8500 09 . . . *	45.10 1.776	22.22 .875	116.00 4.567	102.00 4.016	41.70 1.642	110.00 4.331	116.00 4.567

* specifications for caps style and plating see table.

type protective cap	olive	nickel	for recept. style
cap with chain and ring	D	44 D	8 ST 0
cap with nylon cord and ring	B	44 B	8 ST 0
cap with nylon cord and washer	H	-	8 ST 7
cap with chain and washer	J	-	8 ST 7



Accessories

Plastic protective cap

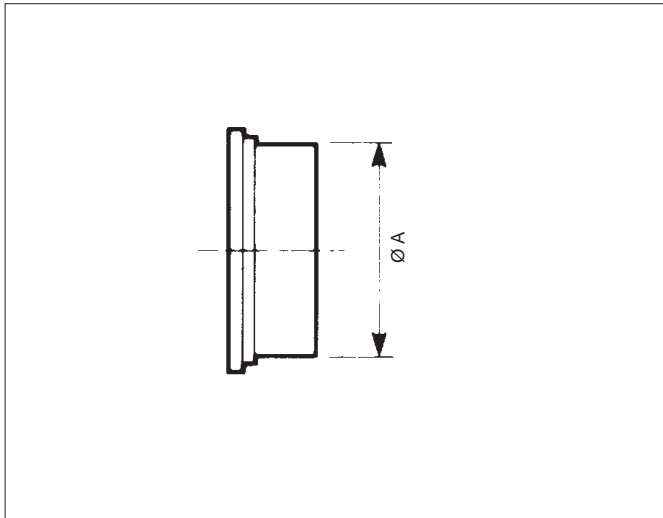

shell size	Dimension A		Part number	
	caps for receptacles	caps for plugs	caps for receptacles	caps for plugs
08	15.40 .606	19.72 .776	85005585A	70777
10	18.30 .720	19.72 .776	85005586A	MS9037612
12	22.63 .891	-	85005587A	MS9037616Y
14	25.80 1.016	30.80 1.210	85005588A	8500-5600
16	29.20 1.150	35.90 1.413	85005589A	8500-5601
18	32.40 1.276	37.00 1.46	85005590A	8500-5602
20	35.60 1.402	39.00 1.54	85005591A	8500-5592A
22	39.00 1.535	42.200 1.661	85005592A	8500-5593A
24	42.20 1.661	44.50 1.752	85005593A	70472

Dummy receptacle

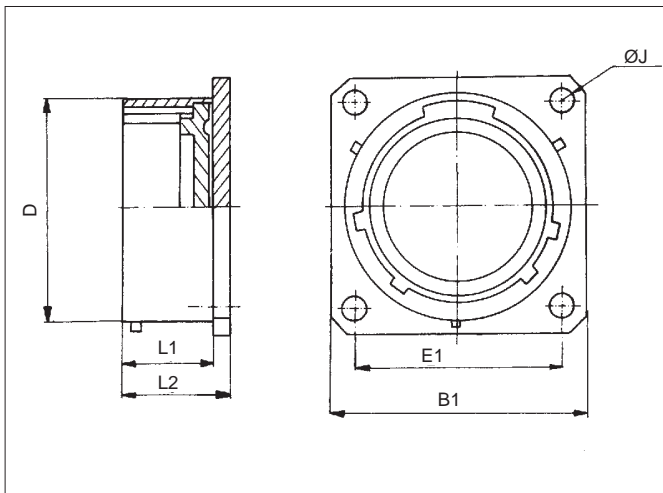

shell size	Part number	B1	E1	J	D1	L1	L2 Max
08	8ST0.08GUR	20.73 .816	15.10 .594	3.14 .124	11.97 .471	16.05 .632	18.19 .716
10	8ST0.10GUR	23.94 .943	18.26 .719	3.14 .124	14.94 .588	16.05 .632	18.19 .716
12	8ST0.12GUR	26.32 1.036	20.62 .812	3.14 .124	19.01 .748	16.05 .632	18.19 .716
14	8ST0.14GUR	28.71 1.130	23.01 .906	3.14 .124	22.18 .873	16.05 .632	18.19 .716
16	8ST0.16GUR	31.07 1.223	24.61 .969	3.14 .124	25.36 .998	16.05 .632	18.19 .716
18	8ST0.18GUR	33.43 1.316	26.98 1.062	3.14 .124	28.53 1.123	16.05 .632	18.19 .716
20	8ST0.20GUR	36.63 1.442	29.38 1.157	3.14 .124	31.71 1.248	15.29 .602	18.19 .716
22	8ST0.22GUR	39.81 1.567	31.77 1.251	3.14 .124	34.88 1.373	15.29 .602	18.19 .716
24	8ST0.24GUR	42.98 1.692	34.92 1.375	3.14 .124	38.06 1.498	15.29 .602	18.19 .716

Gaskets

shell size	Gasket for receptacle type 0	O-Ring for receptacle type 7
08	8590-2251	AS3582-017
10	8590-2252	AS3582-019
12	8590-2253	AS3582-022
14	8590-2254	AS3582-024
16	8590-2255	AS3582-026
18	8590-2256	AS3582-028
20	8590-2257	AS3582-128
22	8590-2258	AS3582-130
24	8590-2259	AS3582-132

Notes : - gaskets correspond to the temperature resistance of Serie 8 ST (max. 175 °C)
 - for use up to 125 °C we offer gaskets in accordance with VG 95 328
 e.g. : VG 95 328 T 07 A... = non conductive
 VG 95 328 T 07 B... = conductive (for HF application)

8ST Series



Panel cut-out

8 ST 0 style

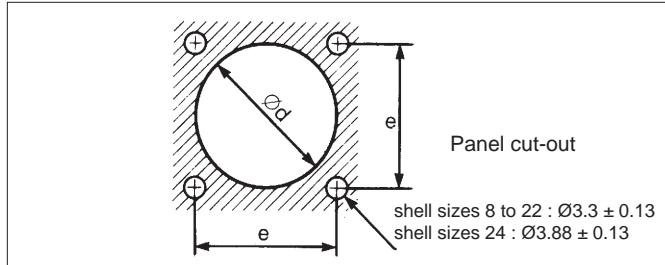

8 ST 7 style

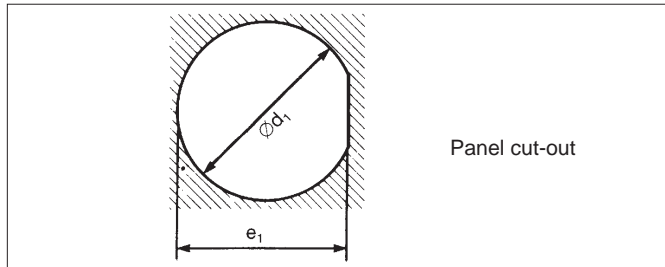

shell size	8ST0...			8ST 7...	
	back panel mounting	front panel mounting	e H13	d1 H13	e1 H13
08	14.00	12.70	15.10	14.50	13.60
	.551	.500	.594	.571	.535
10	17.00	16.00	18.30	17.70	16.80
	.669	.630	.720	.697	.661
12	22.00	19.00	20.60	22.70	20.90
	.866	.748	.811	.894	.823
14	25.00	22.20	23.00	25.70	24.10
	.984	.874	.906	1.012	.949
16	28.00	25.50	24.60	28.80	27.20
	1.102	1.004	.969	1.134	1.071
18	31.00	28.50	27.00	32.00	30.40
	1.220	1.122	1.063	1.260	1.197
20	34.50	31.70	29.40	35.10	33.60
	1.358	1.248	1.157	1.382	1.323
22	37.50	35.00	31.80	38.00	36.80
	1.476	1.378	1.252	1.496	1.449
24	41.00	38.00	34.90	41.50	39.90
	1.614	1.496	1.374	1.634	1.571