

8D - D38999 Composite Series



MIL-DTL-38999 Serie III Composite Series



8D - D38999 Composite Series

Connector part numbers

Basic Series	8D	0	-	11	J	35	P	N	-	-	L
Shell style:											
0: Square flange receptacle											
5: Plug with RFI shielding											
Type:											
None: Connectors with standard crimp contacts.											
L: Receptacle with long spill (male and female size #22D, #20).											
C: Receptacle with short spill (male and female #22D, #20, #16).											
S: Receptacle with specific spill (male et female #22D)											
W: Receptacle with male contacts #22D for wire wrap (3 wraps)											
T: Receptacle with male contacts #20 for wire wrap (2 wraps)											
P: Receptacle with solder cup (male and female size #22D; male #16 & #12; female #16 & #12 and male female #20 please consult us)											
Shell size: 09 - 11 - 13 - 15 - 17 - 19 - 21 - 23 - 25											
Plating:											
J: Olive drab cadmium											
M: Nickel											
X: Without plating											
Contact layout: See page 10 to 13											
Contact type:											
P: Pin (500 mating/unmating)											
H: Pin (1500 mating/unmating)											
A: Connector supplied less pin contact or with specific contacts (connector marking: A + orientation)											
S: Socket (500 mating/unmating)											
J: Socket (1500 mating/unmating)											
B: Connector supplied less socket contact or with specific contacts (connector marking: B + orientation)											
Orientation: N, A, B, C, D & E (see page 63)											
Specification:											
046: Tinned straight spills											
251: Connector provided with power contacts (layouts with contact #8)											
022: Fuel tank											
Special custom:											
None: Standard plastic cap											
M: Antistatic plastic cap											
L: For P or S contact type only, connectors delivered without contacts, connectors marking P or S plus orientation.											

MIL-DTL-38999 part numbers*

Basic Series	D38999	20	M	B	35	P	N	L
Shell style:								
20: Square flange receptacle								
26: Plug with RFI shielding.								
Plating:								
J: Olive drab cadmium								
M: Nickel								
Shell size: A - B - C - D - E - F - G - H - J								
Contact layout: See page 14 for layout according to MIL-DTL-38999								
Contact type:								
P: Pin (500 mating/unmating)								
H: Pin (1500 mating/unmating)								
A: Connector supplied less pin contact or with specific contacts (connector marking: A + orientation)								
S: Socket (500 mating/unmating)								
J: Socket (1500 mating/unmating)								
B: Connector supplied less socket contact or with specific contacts (connector marking: B + orientation)								
Orientation: N, A, B, C, D & E (see page 63)								
L: For P or S contact type only, connector delivered without contacts, connector marking P or S (without L)								

* Note: To place an order of MIL connectors delivered without MIL removable crimp contacts and keep P or S plus orientation marking, it must be specify clearly on the order (by adding a suffix L at the end of the P/N or specified in comment).

8D - D38999 Composite Series



Dimensions

Receptacle type 0

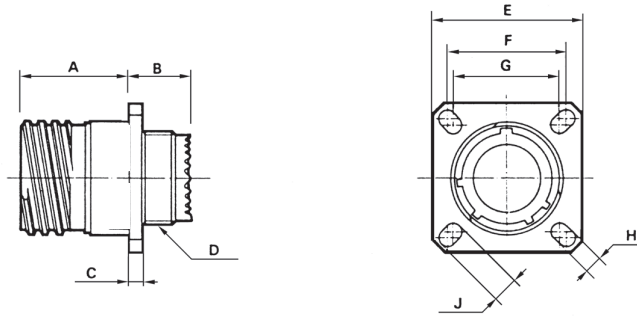

Shell size	A Max.	B Max.	C Max.	D thread	E $\pm 0,30$	F	G	H $\pm 0,20$	J $\pm 0,20$
09 (A)	19.65	11.96	3.65	M12 x 1-6g	23.80	18.26	15.09	3.25	5.49
11 (B)	19.65	11.96	3.65	M15 x 1-6g	26.20	20.62	18.26	3.25	4.93
13 (C)	19.65	11.96	3.65	M18 x 1-6g	28.60	23.01	20.62	3.25	4.93
15 (D)	19.65	11.96	3.65	M22 x 1-6g	31.00	24.61	23.01	3.25	4.39
17 (E)	19.65	11.96	3.65	M25 x 1-6g	33.30	26.97	24.61	3.25	4.93
19 (F)	19.65	11.96	3.65	M28 x 1-6g	36.50	29.36	26.97	3.25	4.93
21 (G)	18.85	12.76	4.35	M31 x 1-6g	39.70	31.75	29.36	3.25	4.93
23 (H)	18.85	12.76	4.35	M34 x 1-6g	42.90	34.93	31.75	3.91	6.15
25 (J)	18.85	12.76	4.35	M37 x 1-6g	46.00	38.10	34.93	3.91	6.15

Dimensions in millimeters

8D - D38999 Composite Series



Plug type 5

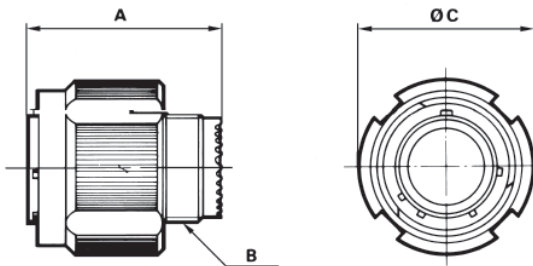

Shell size	A Max.	B thread	C Max.
09 (A)	31.00	M12 x 1-6g	21.80
11 (B)	31.00	M15 x 1-6g	25.00
13 (C)	31.00	M18 x 1-6g	29.40
15 (D)	31.00	M22 x 1-6g	32.50
17 (E)	31.00	M25 x 1-6g	35.70
19 (F)	31.00	M28 x 1-6g	38.50
21 (G)	31.00	M31 x 1-6g	41.70
23 (H)	31.00	M34 x 1-6g	44.90
25 (J)	31.00	M37 x 1-6g	48.00

Mated connectors dimensions

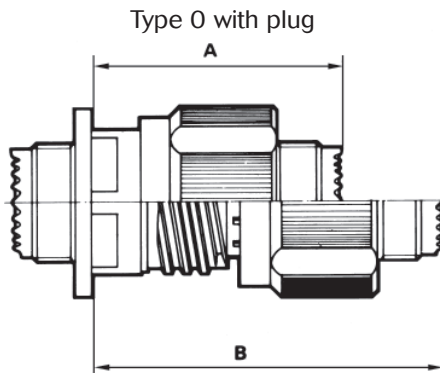

Shell size	A Max.	B Max.
09 (A)	37.00	52.30
11 (B)	37.00	52.30
13 (C)	37.00	52.30
15 (D)	37.00	52.30
17 (E)	37.00	52.30
19 (F)	37.00	52.30
21 (G)	36.00	51.30
23 (H)	36.00	51.30
25 (J)	36.00	51.30

Dimensions in millimeters

8D - D38999 Composite Series



Receptacle with straight spill contacts

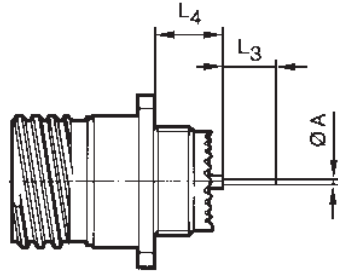

	Shell size			09 (A)	11 (B)	13 (C)	15 (D)	17 (E)	19 (F)	21 (G)	23 (H)	25 (J)
	Contact size	Contact type	Spill type									
A	# 22D	M & F	L & C					0.70				
	# 22D	M & F	S					0.50				
	# 20	M & F	C					0.70				
	# 16	M & F	C					1.15				
L3	# 22D	M & F	L					8.50				
	# 22D	M & F	C					4.00				
	# 22D	M & F	S					5.00				
	# 20	M & F	C					5.00				
	# 16	M & F	C					5.00				
L4	Min.	# 22D	M					9.48				
	Max.	# 22D	M				10.38				10.48	
	Min.	# 22D	F				9.15				9.26	
	Max.	# 22D	F				10.58				10.69	
	Min.	# 22D	M				9.65				9.76	
	Max.	# 22D	M				10.55				10.65	
	Min.	# 22D	F				9.65				9.76	
	Max.	# 22D	F				10.55				10.65	
	Min.	# 20	M				9.65				9.76	
	Max.	# 20	M				10.55				10.65	
	Min.	# 20	F				9.65				9.76	
	Max.	# 20	F				10.55				10.65	
	Min.	# 16	M				9.65				9.76	
	Max.	# 16	M				10.55				10.65	
	Min.	# 16	F				9.65				9.76	
	Max.	# 16	F				10.55				10.65	

M : Male contact F: Female contact L: Long spill C : Short spill S: Specific spill

Dimensions in millimeters

8D - D38999 Composite Series



Standard backshells part numbers

Straight cable clamp (M85049/91)

Basic series M85049 91 11 M

Backshell type:
91: Straight cable clamp

Shell size:
09 - 11 - 13 - 15 - 17 - 19 - 21 - 23 - 25

Plating:
J: Cadmium olive drab over electroless nickel
M: Electroless nickel
T: Without plating

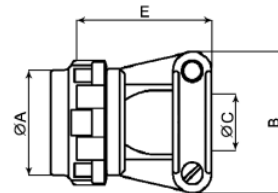

See table 1 for dimensions

90° cable clamp (M85049/92)

Basic series M85049 92 11 M

Backshell type:
92: 90° cable clamp

Shell size:
09 - 11 - 13 - 15 - 17 - 19 - 21 - 23 - 25

Plating:
J: Cadmium olive drab over electroless nickel
M: Electroless nickel
T: Without plating

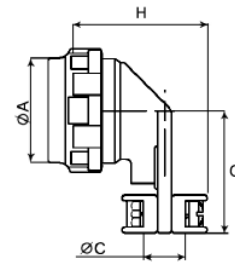

See table 1 for dimensions

Table 1

Shell size	ØA Max.	B Max.	ØC Max.	E Max.	G	H
09	21.80	24.90	5.55	21.25	22.20	26.95
11	25.00	26.0	6.70	24.30	23.80	27.95
13	29.40	30.50	8.75	27.95	26.20	30.00
15	32.50	33.00	11.70		28.60	33.00
17	35.70	36.10	13.85	31.25	33.30	35.05
19	38.50	38.60	15.60	35.80	34.95	36.85
21	41.50	41.65	17.75	38.35	38.10	39.15
23	44.90	45.00	19.80	42.15	41.30	41.15
25	48.00	48.00	21.60	44.70	44.45	42.95

Dimensions in millimeters

8D - D38999 Composite Series



Straight backshell for heat shrink boots accommodation (M85049/88)

Basic series **M85049** **88** **11** **M** **02**

Backshell type:

88: Straight backshell for heat shrink boots

Shell size:

09 - 11 - 13 - 15 - 17 - 19 - 21 - 23 - 25

Plating:

J: Cadmium olive drab over electroless nickel

M: Electroless nickel

Entry size:

02 ou **03:** see table 2

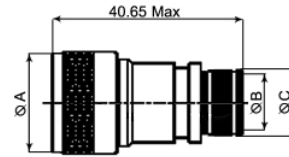

See tableau 2 for dimensions

Table 2

Shell size	ØA Max.	ØB +/- 0.10 Entry size		ØC	
		02	03	02	03
09	21.79	N/A	6.35	N/A	10.03
11	24.99	N/A	7.92	N/A	11.61
13	29.39	7.92	11.13	11.61	14.81
15	32.49	11.13	14.27	14.81	17.96
17	35.71	12.70	15.88	16.38	19.56
19	38.51	15.88	19.05	19.56	22.73
21	41.71	15.88	20.62	19.56	24.30
23	44.91	17.47	23.83	21.06	27.51
25	47.98	19.05	25.40	22.73	29.08

Dimensions in millimeters

8D - D38999 Composite Series



Connectors weight

	With contacts				Without contact			
	Plug (type 5)		Receptacle (type 0)		Plug (type 5)		Receptacle (type 0)	
	Male	Female	Male	Female	Male	Female	Male	Female
09-35	8.5	10.1	7.8	9.4	8.1	8.6	7.4	7.9
09-98	8.5	9.8	7.8	9.1	8.1	8.6	7.4	7.9
11-01	12.8	15.7	10.4	13.3	12.1	14.1	9.7	11.7
11-02	11.5	14.1	09.3	11.8	10.9	12.5	08.7	10.3
11-04	12.6	15.7	10.2	13.3	12.0	14.1	9.7	11.7
11-05	12.6	15.8	10.2	13.4	11.9	13.8	9.5	11.5
11-22	11.4	13.8	09.1	11.6	11.1	12.8	08.8	10.6
11-35	12.5	16.0	10.1	13.6	11.6	12.8	9.2	10.4
11-80	15.25	18.6	13.40	10.4	10.75	11.63	08.90	09.4
11-98	12.5	15.3	10.1	12.9	11.7	12.8	9.3	10.5
11-99	11.8	15.0	09.6	12.8	10.8	12.2	08.6	10.0
13-04	17.2	20.9	13.7	17.5	15.6	17.9	12.4	14.3
13-08	17.6	22.8	14.1	19.2	16.5	19.6	12.9	16.1
13-26	17.9	23.6	14.4	20.1	16.2	18.9	12.7	15.4
13-35	17.4	23.1	13.8	19.6	15.8	17.6	12.3	14.1
13-98	17.2	21.8	13.7	18.3	15.8	17.9	12.3	14.3
15-05	21.4	26.7	16.6	21.9	19.8	22.8	15.0	18.0
15-15	22.2	29.3	17.4	24.5	19.9	23.0	15.1	18.1
15-18	22.4	31.3	17.6	26.5	19.9	24.0	15.0	19.2
15-19	22.0	29.6	17.1	24.8	19.2	22.0	14.5	17.2
15-35	22.0	31.3	17.2	26.5	19.4	22.0	14.6	17.2
15-97	21.8	28.9	17.1	24.1	19.4	22.6	14.7	17.8
17-02	26.51	38.85	25.23	37.57	19.35	22.35	18.07	21.07
17-06	25.9	35.5	23.2	32.8	21.9	25.9	19.2	23.2
17-08	24.9	33.6	22.2	30.1	22.4	27.4	19.7	24.7
17-26	25.5	36.3	22.8	33.6	21.8	25.9	19.2	23.1
17-35	25.7	39.3	23.0	36.6	21.9	25.5	19.2	22.8
17-75	31.3	42.6	28.6	39.9	22.3	28.6	19.6	25.9
17-99	25.5	36.1	22.8	33.4	22.0	26.1	19.3	23.4
19-11	32.1	45.7	26.1	39.7	28.7	37.1	22.7	31.1
19-32	31.3	44.7	25.3	38.7	26.8	31.9	20.8	25.9
19-35	31.6	48.1	25.6	42.0	27.1	31.6	21.0	25.6
21-11	38.0	57.9	32.8	52.6	30.8	40.3	25.5	35.1
21-16	35.1	50.4	29.9	45.2	30.2	37.9	24.9	32.7
21-35	35.4	56.1	30.1	50.8	29.9	36.3	24.6	31.1
21-39	36.8	57.1	31.5	51.9	31.0	40.8	25.7	35.5
21-41	35.3	52.7	30.1	47.5	29.6	36.3	24.3	31.0
21-48	42.41	62.40	37.71	57.70	29.3	36.2	24.6	31.5
21-75	47.3	64.2	42.6	59.50	29.3	36.2	24.6	31.5
23-21	43.1	66.3	38.0	61.2	36.5	49.9	31.5	44.8
23-35	41.4	67.5	36.3	62.5	34.4	42.5	29.3	37.5
23-53	41.5	63.6	36.4	58.6	34.1	42.4	29.0	37.4
23-55	42.2	65.3	42.2	60.2	34.5	43.3	29.4	38.2
25-07	53.6	90.05	49.0	84.85	37.8	51.8	33.2	46.6
25-11	59.08	81.60	54.48	77.00	40.8	53.8	36.2	49.2
25-19	51.7	83.7	46.6	78.6	39.2	53.3	34.0	48.2
25-24	51.2	82.5	46.1	77.4	39.6	54.0	34.4	48.9
25-29	49.5	78.5	44.4	73.4	40.5	55.9	35.4	50.7
25-35	47.3	80.1	42.2	75.0	38.4	48.1	33.2	43.0
25-37	49.27	80.36	45.47	76.16	37.8	51.50	34.0	47.30
25-44	69.64	93.70	65.04	94.65	36.1	45.80	31.5	46.75
25-43	49.6	80.2	44.4	75.1	40.1	55.4	35.0	50.3
25-46	51.9	75.7	46.7	70.1	37.2	47.4	32.1	42.2
25-61	46.6	73.4	41.5	68.2	38.1	48.9	32.9	43.8
25-08	72.9	104.8	67.8	99.6	36.9	48.8	31.8	43.6
25-20	57.9	88.2	52.8	83.0	36.4	46.6	31.3	41.5
25-04	50.4	80.2	45.3	75.0	41.2	54.8	36.1	49.6