

# User-friendly auto locking connector

## HR34B series

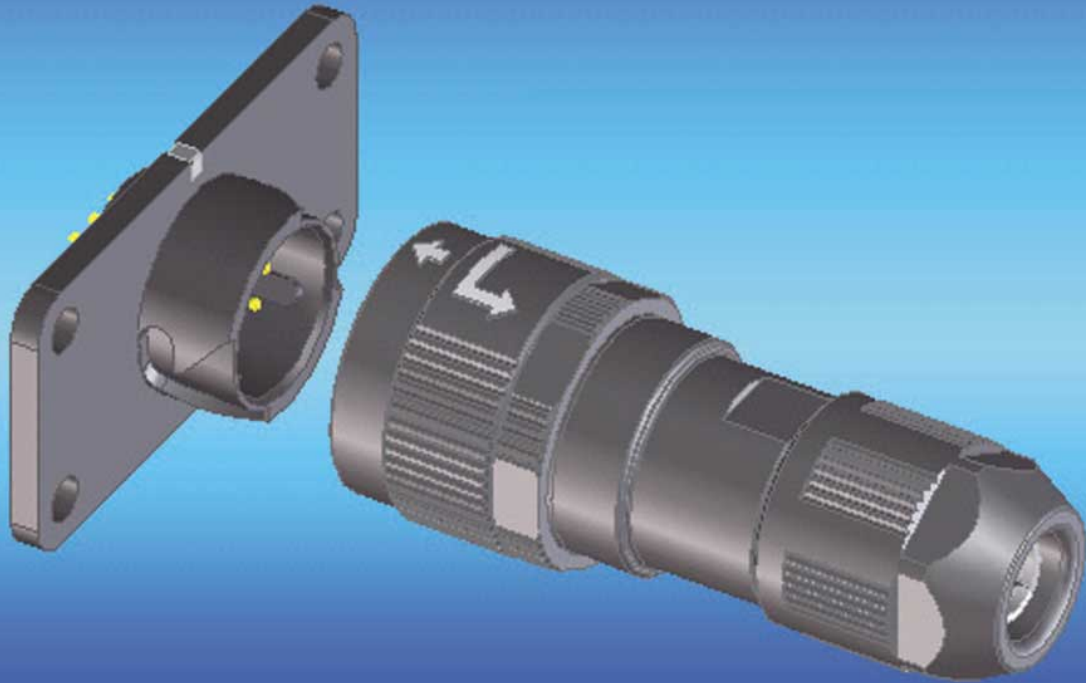

## Features

- User-friendly auto locking
- IP67 waterproof
- 4 and 10 pins available
- Right angled plug and crimp type available for 10 pins

# HRS

HIROSE ELECTRIC CO.,LTD.

# Applications

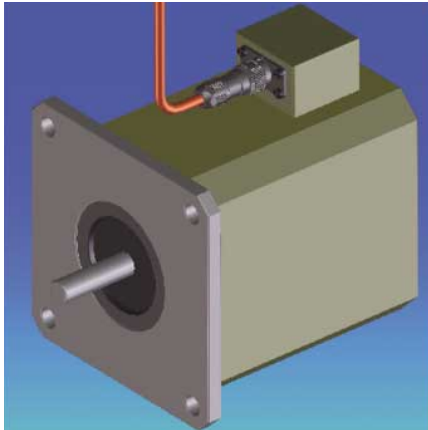

- **Servo motor**
- FA robots
- CNC machines
- Telecom equipments

## Main feature

### ■ For mating

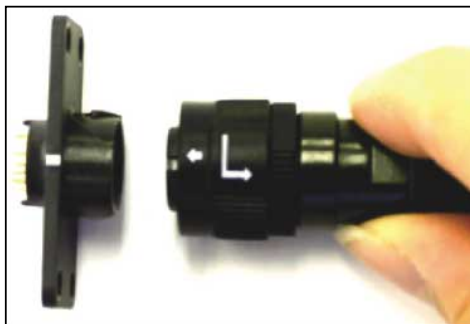

Push the shell



Lock completed

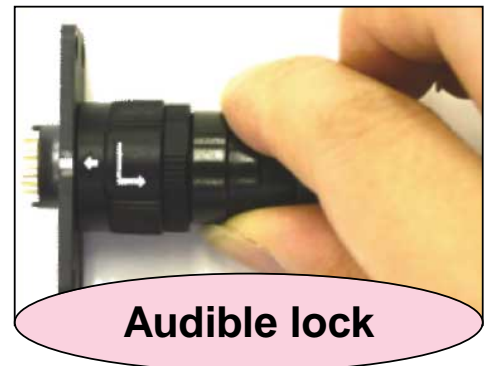

### ■ For unmating



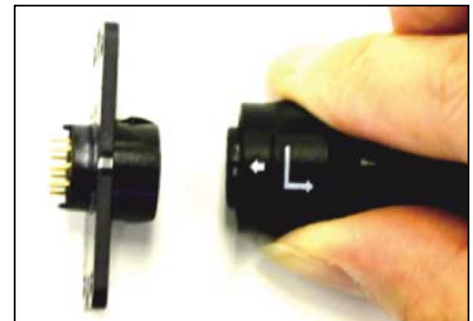

Turn the coupling sleeve and pull the plug





**Original designed auto locking mechanism helps to operate easy and quick mating and unmating. It provides security against vibration, shocks and pulling on the cable.**

# Varieties

## ■ Receptacles

10 pin		4 pin
Rectangular	Square	Square
HR34B-12WR-10PD	HR34B-12WRA-10P	HR34B-12WRB-4P
Solder mount on PCB	Solder wire termination	Solder wire termination
		

## ■ Plugs

	10 pin		4 pin	
	Straight	Right angled	Straight	Right angled
Solder termination	HR34B-12WPA-10S( $\phi A$ ) HR34B-12WPB-10S( $\phi B$ )	HR34B-12WLPA-10S( $\phi A$ ) HR34B-12WLPB-10S( $\phi B$ )	HR34B-12WPD-4S( $\phi A$ ) HR34B-12WPE-4S( $\phi B$ )	Under development
Crimp termination	HR34B-12WPA-10SC( $\phi A$ ) HR34B-12WPB-10SC( $\phi B$ )	HR34B-12WLPA-10SC( $\phi A$ ) HR34B-12WLPB-10SC( $\phi B$ )		
				

## ■ Plugs for flexible conduit

<b>10 pin straight</b>	HR34B-12WPF-10S( $\phi A$ ) HR34B-12WPG-10S( $\phi B$ )
<b>10 pin right angled</b>	HR34B-12WLPF-10S( $\phi A$ ) HR34B-12WLPG-10S( $\phi B$ )
<b>4 pin straight</b>	HR34B-12WPH-4S( $\phi A$ ) HR34B-12WPK-4S( $\phi B$ )

Note :  $\phi A$  is for from 5.7 to 7.3mm and  $\phi B$  is for from 6.5 to 8mm cable diameter.

# Specifications

	10 pin	4 pin
Rated voltage	AC 30V, DC42 V	AC 200V
Dielectric withstanding voltage	AC 900V	AC 2000V
Insulation resistance	1000MΩ min	
Rated current	3A	5A
Applicable wire	up to AWG 24	up to AWG 20
Wire termination	Soldering or crimping	Soldering

#### USA:

##### HIROSE ELECTRIC(U.S.A.), INC.

2688 Westhills Court, Simi Valley, CA 93065-6235  
 Phone : 1 805 522 7958  
 Fax : 1 805 522 3217  
<http://www.hiroseusa.com>

#### UNITED KINGDOM:

##### HIROSE ELECTRIC UK LTD.

Crownhill Business Centre 22 Vincent Avenue  
 Crownhill, Milton Keynes MK8 OAB  
 Phone : 44 1908 305400  
 Fax : 44 1908 305401  
<http://www.hirose.co.uk>

#### HONG KONG:

##### HIROSE ELECTRIC CO., LTD.

Unit 1101, 1102A & B, Energy Plaza, 92 Granville  
 Road, TST East, Kowloon  
 Phone : 852 2803 5338  
 Fax : 852 2591 6560  
<http://www.hirose-hongkong.com.hk>

#### GERMANY:

##### HIROSE ELECTRIC GmbH

Herzog-Carl-Strasse 4 D-73760 Ostfildern  
 (Scharnhauser Park)  
 Phone : 49 711 4560 02 1  
 Fax : 49 711 4560 02 299  
<http://www.hirose.de>

#### KOREA:

##### HIROSE KOREA CO., LTD.

(#2NA311,Shihwa Industrial Complex),1261-10,  
 Jeoungwhang-Dong, Shihung-City, Kyunggi-Do 429-450  
 Phone : 82 31 496 7000,7124  
 Fax : 82 31 496 7100  
<http://www.hirose.co.kr>

#### TAIWAN:

##### HIROSE ELECTRIC TAIWAN CO., LTD.

No.28 Lane 247 Sec. 2 Yen Ping N,Rd.Taipei  
 Phone : 886 2 2557 7351,7352  
 Fax : 886 2 2552 9851  
<http://www.hirose-taiwan.com.tw>

#### THE NETHERLANDS:

##### HIROSE ELECTRIC EUROPE B.V.

Beechavenue 46,1119 PV  
 Schiphol-Rijk  
 Phone : 31 20 6557490  
 Fax : 31 20 6557469  
<http://www.hiroseurope.com>

#### CHINA:

##### HIROSE ELECTRIC TRADING(SHANGHAI) CO., LTD.

1501-02, Cross Tower Building 318 Fuzhou Road,  
 Huang Pu District Shanghai, 200001  
 Phone : 86 21 6335 2538  
 Fax : 86 21 6335 0767  
<http://www.hirose-china.com.cn>

#### SINGAPORE:

##### HIROSE ELECTRIC CO., LTD.

10 Anson Road #26-16 International Plaza 079903  
 Phone : 65 6324 6113  
 Fax : 65 6324 6123  
<http://www.hirose-singapore.com.sg>



## HIROSE ELECTRIC CO.,LTD.

5-23,OSAKI 5-CHOME,SHINAGAWA-KU,TOKYO 141-8587,JAPAN  
 PHONE: 81-3-3491-9741, FAX: 81-3-3493-2933  
<http://www.hirose.com>  
<http://www.hirose-connectors.com>