

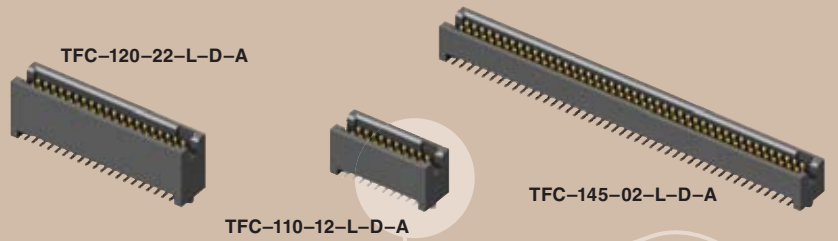

(1,27mm) .050"

TFC SERIES



# COST SAVING RELIABLE HEADER

## SPECIFICATIONS

For complete specifications and recommended PCB layouts see [www.samtec.com?TFC](http://www.samtec.com?TFC)

### Insulator Material:

Black Liquid Crystal Polymer

### Terminal Material:

Phosphor Bronze

### Plating:

Au or Sn over 50µ" (1,27µm) Ni

### Voltage Rating:

350 VAC mated with SFC

### Operating Temp Range:

-55°C to +125°C

### RoHS Compliant:

Yes



Mates with: SFC, SFS, SFS, SFS

## MATED HEIGHTS

| LEAD STYLE | SFC | MATED HEIGHT* |
|------------|-----|---------------|
| -01        | -T1 | (5,97) .235   |
| -11        |     | (7,75) .305   |
| -21        |     | (9,53) .375   |
| -31        |     | (11,43) .450  |
| -02        | -T2 | (6,35) .250   |
| -12        |     | (8,13) .320   |
| -22        |     | (9,91) .390   |
| -32        |     | (11,81) .465  |

\*Processing conditions will affect mated height.

Shrouded body for blind mating

(1,27mm x 1,27mm) .050" x .050" micro pitch

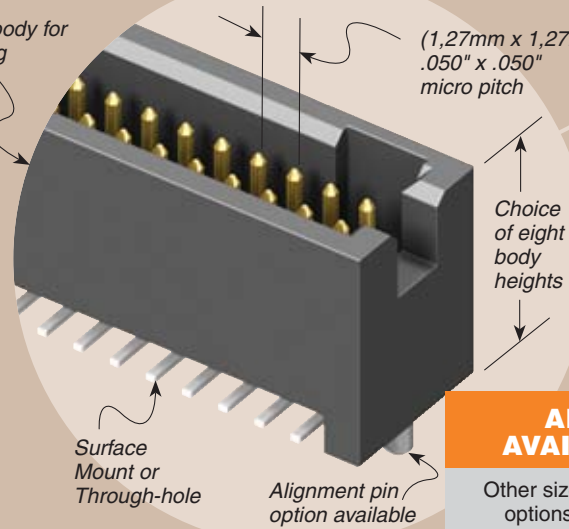

Surface Mount or Through-hole

Alignment pin option available

## ALSO AVAILABLE

Other sizes and more options available. Contact Samtec.

| CURRENT RATING |         |
|----------------|---------|
| AMBIENT TEMP   | SFS/SFC |
| 20°C           | 3.7A    |
| 40°C           | 3.4A    |
| 60°C           | 2.9A    |
| 95°C           | 1.9A    |

6 POSITIONS (2x3) POWERED

## Processing:

Lead-Free Solderable:

Yes

### SMT Lead Coplanarity:

(0,10mm) .004" max (10-25)

(0,15mm) .006" max (30-50)



10, 15, 20, 25, 30, 35, 40, 45, 50  
(Call Samtec for other sizes)

-X1 = Through-hole  
-X2 = Surface Mount

-F = Gold flash on post, Matte Tin on tail  
-L = 10µ" (0,25µm) Gold on post, Matte Tin on tail

-RA = Right Angle (-01 only)  
-A = Alignment Pin  
-K = (6,75mm) .266" DIA Polyimide film Pick & Place Pad  
-TR = Tape & Reel (-X2 only)

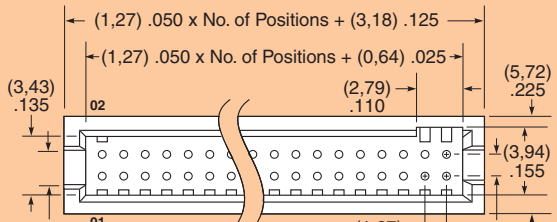

| TH LEAD STYLE | A            | B           |
|---------------|--------------|-------------|
| -01           | (5,59) .220  | (3,38) .133 |
| -11           | (7,37) .290  |             |
| -21           | (9,14) .360  | (3,30) .130 |
| -31           | (11,05) .435 |             |

| SMT LEAD STYLE | A            | B           |
|----------------|--------------|-------------|
| -02            | (5,72) .225  | (3,38) .133 |
| -12            | (7,49) .295  |             |
| -22            | (9,27) .365  | (3,30) .130 |
| -32            | (11,18) .440 |             |

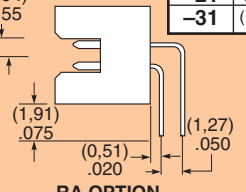
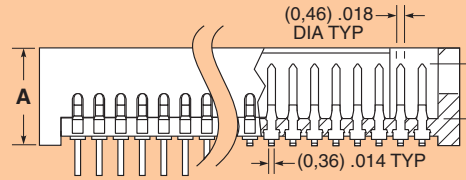

-RA OPTION

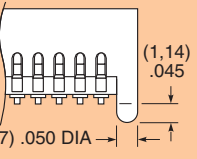
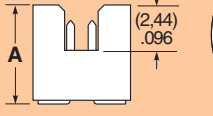

-A OPTION

**TAPE & REEL AVAILABILITY**  
No tooling charges.  
Minimum order is the lesser of a full reel quantity or 125 pieces.  
Order any quantity above minimum.  
In-house design, manufacture.  
Quick turn-around.  
Call Samtec for specifications and ordering information.

Note: Some sizes, styles and options are non-standard, non-returnable.

Due to technical progress, all designs, specifications and components are subject to change without notice.

WWW.SAMTEC.COM

SAMTEC USA • Tel: 1-800-SAMTEC-9 or 812-944-6733 SAMTEC SILICON VALLEY • Tel: 408-395-5900 SAMTEC SOUTHERN CALIFORNIA • Tel: 1-800-726-8329  
SAMTEC AMERICA LATINA COMERCIO EXTERIOR LTDA • Tel: (+55 31) 3786 3227 SAMTEC UNITED KINGDOM • Tel: 44 01236 739292 SAMTEC GERMANY • Tel: +49 (0) 89 / 89460-0  
SAMTEC FRANCE • Tel: 33 01 60 95 06 60 SAMTEC ITALY • Tel: 39 039 8890337 SAMTEC NORDIC/BALTIC • Tel: +46-84477280 SAMTEC BENELUX • Tel: 44 01236 739292 SAMTEC ISRAEL • Tel: 972-3-7526600  
SAMTEC INDIA • Tel: +91-80-3272 1612 SAMTEC ASIA PACIFIC • Tel: 65 6745-5955 SAMTEC JAPAN • Tel: 045-475-1385 SAMTEC CHINA • Tel: 86-21-61103766 SAMTEC TAIWAN • Tel: 886-2-2735-6109  
Downloaded from Elcodis.com electro SAMTEC HONG KONG • Tel: 852-2600-9858 SAMTEC KOREA • Tel: 82-31-717-5685 SAMTEC ANZ • Tel: 613 9512 7747 SAMTEC SOUTH AFRICA • Tel: 27 11 452 8112