

6 5 4 3 2 1

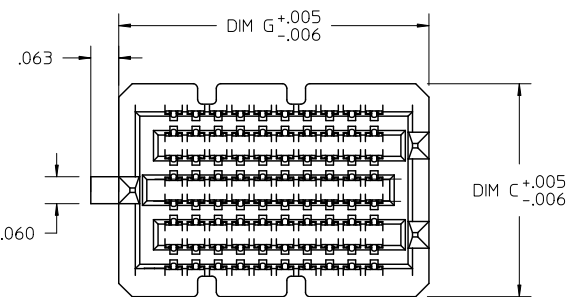

- NOTES:
1. MATERIAL: HOUSING: LCP, UL94V-0, BLACK
CONTACTS: COPPER ALLOY
SOLDER CHARGE: SEE CHARTS
 2. FINISH: ALL DIM P HEIGHT OPTIONS - SELECT GOLD IN CONTACT AREA: 30 MI MIN
DIM P HEIGHT OPTIONS 2.0 & 2.5: SELECT GOLD FLASH IN TAIL, 7 MI MIN
DIM P HEIGHT OPTIONS 3.0 THRU 7.0: SELECT TIN IN TAIL, 100 MI MIN
ALL DIM P HEIGHT OPTIONS - OVER NICKEL
 3. PRODUCT SPECIFICATION: PS-45970-001
 4. PACKAGING SPECIFICATION: SEE CHART
 5. MATES WITH SEARAY RECEPTACLE ASSY 45971
 6. APPLICATION SPECIFICATION: AS-45970-001
 7. COSMETIC SPECIFICATION: PS-45499-002 CLASS B
 8. PART STATUS: CONTACT MOLEX

POSITION	∅
19	.006
10	.006
20	.006
30	.006
40	.006
50	.006
15	.006
25	.006
35	.009
45	.009

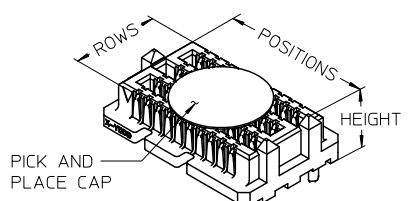
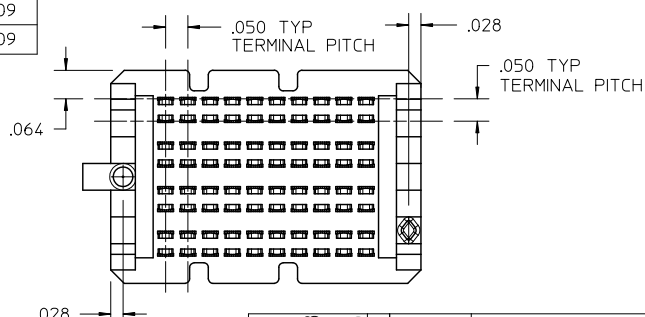
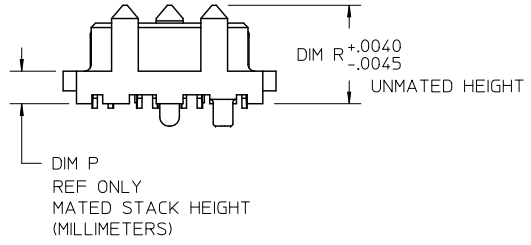
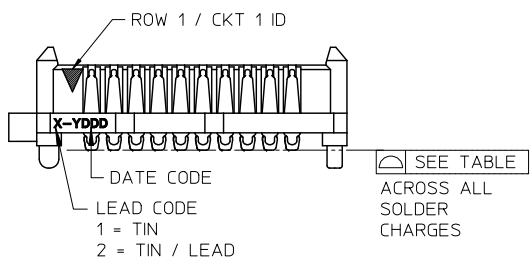

HOUSING OPTIONS
SEE CHARTS

ADDED SOLDER COMP EC NO: UCP2011-2778 DRWN: TREGORI 2011/03/28 CHKD: JCOMERC I APPR: JCOMERC I	2011/04/06	DESCRIPTION
	REV	

GENERAL TOLERANCES (UNLESS SPECIFIED)	
mm	INCH
4 PLACES ±---	±---
3 PLACES ±---	±.010
2 PLACES ±---	±.015
1 PLACE ±---	±---
ANGULAR ±---°	

DIMENSION STYLE INCH ONLY	
DRAWN BY	DATE
TGREGOR I	2005/01/27
CHECKED BY	DATE
JCOMERC I	
APPROVED BY	DATE
JCOMERC I	2010/03/05

SCALE 3:1	DESIGN UNITS INCH	THIRD ANGLE PROJECTION
TITLE		
SEARAY PLUG ASSEMBLY .050 CENTERS		
MOLEX MOLEX INCORPORATED		SHEET NO. 1 OF 10
DOCUMENT NO. SD-45970-001		

DRAFT WHERE APPLICABLE MUST REMAIN WITHIN DIMENSIONS

SEE CHART
THIS DRAWING CONTAINS INFORMATION THAT IS PROPRIETARY TO MOLEX INCORPORATED AND SHOULD NOT BE USED WITHOUT WRITTEN PERMISSION

tb_frame_A_P_AM_I
Rev. E 2006/04/15

5 4 3 2 SD_PACKAGE: CM-45970-001

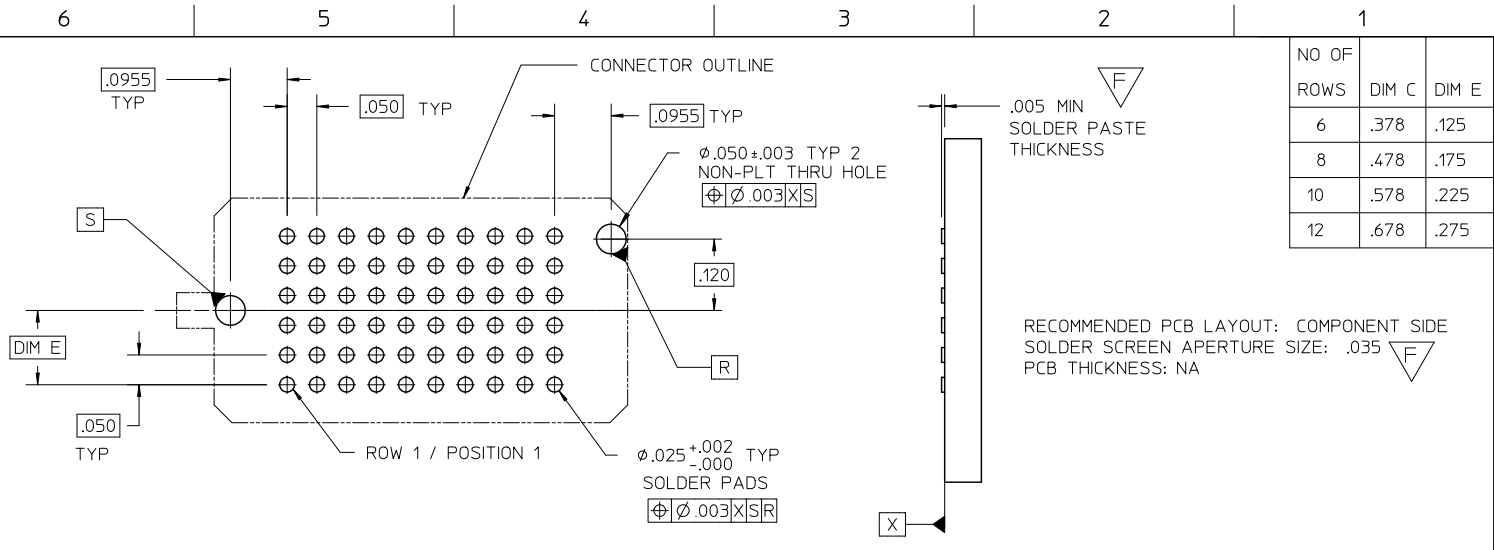

		DIM R RECEPTACLE STACK HEIGHT					
		MM	5.0	6.0	6.5	7.5	8.0
DIM P PLUG STACK HEIGHT	2.0	7.0	8.0	8.5	9.5	10.5	11.0
	3.0	8.0	9.0	9.5	10.5	11.5	12.0
	3.5	8.5	9.5	10.0	11.0	11.5	12.5
	2.5	7.5	8.5	9.0	10.0	10.5	11.5
	4.5	9.5	10.5	11.0	12.0	12.5	13.0
	5.0	10.0	11.0	11.5	12.5	13.0	13.5
	7.0	12.0	13.0	13.5	14.5	15.0	15.5

MATED STACK HEIGHTS
(MILLIMETERS) REF

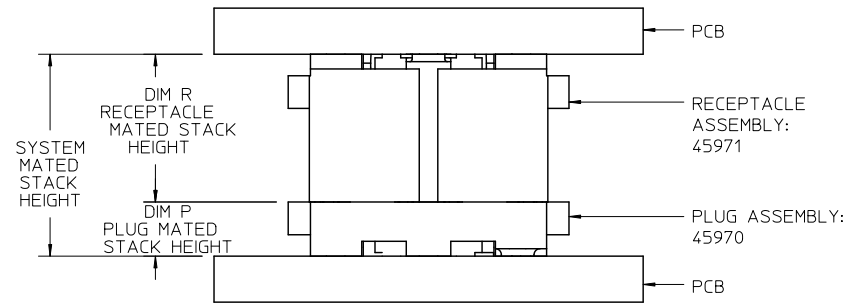

STACK HEIGHTS GIVEN IN METRIC FOR REF ONLY

SEE SHEET 1 EC NO: UCP2011-2778 DRWN: T.GREGORI 2011/03/28 CHKD: APPR: J.COMERC I 2011/04/06 REV DESCRIPTION	GENERAL TOLERANCES (UNLESS SPECIFIED)		DIMENSION STYLE INCH ONLY		SCALE 4:1	DESIGN UNITS INCH	THIRD ANGLE PROJECTION	
		mm	INCH	DRAWN BY T.GREGORI	DATE 2005/01/27	TITLE		
	4 PLACES	±---	±---	CHECKED BY J.COMERC I	DATE	SEARAY PLUG ASSEMBLY .050 CENTERS		
	3 PLACES	±---	±.010	APPROVED BY J.COMERC I	DATE 2010/03/05			
	2 PLACES	±---	±.015	MOLEX INCORPORATED		DOCUMENT NO. SD-45970-001		
1 PLACE	±---	±---	DRAFT WHERE APPLICABLE MUST REMAIN WITHIN DIMENSIONS		SHEET NO. 2 OF 10			

tb_frame_A_P_AM_1
Rev. E 2006/04/15

THIS DRAWING CONTAINS INFORMATION THAT IS PROPRIETARY TO MOLEX INCORPORATED AND SHOULD NOT BE USED WITHOUT WRITTEN PERMISSION

		6		5		4		3		2		1			
DIM P:		2.0 MM		3.0 MM		3.5 MM		2.5 MM		4.5 MM		5.0 MM		7.0 MM	
DIM R:		.221		.260		.280		.241		.319		.339		.418	
POSITION	DIM G	MATERIAL NO	MATERIAL NO	MATERIAL NO	MATERIAL NO	MATERIAL NO	MATERIAL NO	MATERIAL NO	MATERIAL NO	MATERIAL NO	MATERIAL NO	MATERIAL NO	MATERIAL NO		
19	1.146	45970-0161	OBSOLETE	45970-0361	OBSOLETE	OBSOLETE	OBSOLETE	OBSOLETE	OBSOLETE	OBSOLETE	OBSOLETE	OBSOLETE	OBSOLETE		
10	0.696	OBSOLETE	OBSOLETE	OBSOLETE	OBSOLETE	OBSOLETE	OBSOLETE	OBSOLETE	OBSOLETE	OBSOLETE	OBSOLETE	OBSOLETE	OBSOLETE		
20	1.196	OBSOLETE	OBSOLETE	OBSOLETE	OBSOLETE	OBSOLETE	OBSOLETE	OBSOLETE	OBSOLETE	OBSOLETE	OBSOLETE	OBSOLETE	OBSOLETE		
30	1.696	OBSOLETE	OBSOLETE	OBSOLETE	OBSOLETE	OBSOLETE	OBSOLETE	OBSOLETE	OBSOLETE	OBSOLETE	OBSOLETE	OBSOLETE	OBSOLETE		
40	2.196	OBSOLETE	OBSOLETE	OBSOLETE	OBSOLETE	OBSOLETE	OBSOLETE	OBSOLETE	OBSOLETE	OBSOLETE	OBSOLETE	OBSOLETE	OBSOLETE		
50	2.696	OBSOLETE	OBSOLETE	OBSOLETE	OBSOLETE	OBSOLETE	OBSOLETE	OBSOLETE	OBSOLETE	OBSOLETE	OBSOLETE	OBSOLETE	OBSOLETE		
15	0.946	OBSOLETE	OBSOLETE	OBSOLETE	OBSOLETE	OBSOLETE	OBSOLETE	OBSOLETE	OBSOLETE	OBSOLETE	OBSOLETE	OBSOLETE	OBSOLETE		
25	1.446	OBSOLETE	OBSOLETE	OBSOLETE	OBSOLETE	OBSOLETE	OBSOLETE	OBSOLETE	OBSOLETE	OBSOLETE	OBSOLETE	OBSOLETE	OBSOLETE		
35	1.946	OBSOLETE	OBSOLETE	OBSOLETE	OBSOLETE	OBSOLETE	OBSOLETE	OBSOLETE	OBSOLETE	OBSOLETE	OBSOLETE	OBSOLETE	OBSOLETE		
45	2.446	OBSOLETE	OBSOLETE	OBSOLETE	OBSOLETE	OBSOLETE	OBSOLETE	OBSOLETE	OBSOLETE	OBSOLETE	OBSOLETE	OBSOLETE	OBSOLETE		

		6		5		4		3		2		1			
DIM P:		2.0 MM		3.0 MM		3.5 MM		2.5 MM		4.5 MM		5.0 MM		7.0 MM	
DIM R:		.221		.260		.280		.241		.319		.339		.418	
POSITION	DIM G	MATERIAL NO	MATERIAL NO	MATERIAL NO	MATERIAL NO	MATERIAL NO	MATERIAL NO	MATERIAL NO	MATERIAL NO	MATERIAL NO	MATERIAL NO	MATERIAL NO			
19	1.146	45970-0165	45970-0265	45970-0365	45970-0465	45970-0565	45970-0665	45970-0765	45970-0865	45970-0965	45970-1065	45970-1165			
10	0.696	45970-1165	45970-1265	45970-1365	45970-1465	45970-1565	45970-1665	45970-1765	45970-1865	45970-1965	45970-2065	45970-2165			
20	1.196	45970-2165	45970-2265	45970-2365	45970-2465	45970-2565	45970-2665	45970-2765	45970-2865	45970-2965	45970-3065	45970-3165			
30	1.696	45970-3165	45970-3265	45970-3365	45970-3465	45970-3565	45970-3665	45970-3765	45970-3865	45970-3965	45970-4065	45970-4165			
40	2.196	45970-4165	45970-4265	45970-4365	45970-4465	45970-4565	45970-4665	45970-4765	45970-4865	45970-4965	45970-5065	45970-5165			
50	2.696	45970-5165	45970-5265	45970-5365	45970-5465	45970-5565	45970-5665	45970-5765	45970-5865	45970-5965	45970-6065	45970-6165			
15	0.946	45970-6165	45970-6265	45970-6365	45970-6465	45970-6565	45970-6665	45970-6765	45970-6865	45970-6965	45970-7065	45970-7165			
25	1.446	45970-7165	45970-7265	45970-7365	45970-7465	45970-7565	45970-7665	45970-7765	45970-7865	45970-7965	45970-8065	45970-8165			
35	1.946	45970-8165	45970-8265	45970-8365	45970-8465	45970-8565	45970-8665	45970-8765	45970-8865	45970-8965	45970-9065	45970-9165			
45	2.446	45970-9165	45970-9265	45970-9365	45970-9465	45970-9565	45970-9665	45970-9765	45970-9865	45970-9965	45970-0065	45970-0165			

NOTES:
 1. THIS SHEET CONTAINS THE FOLLOWING OPTIONS:
 NO OF ROWS: 6
 SOLDER CHARGE: TIN, 95.5/ Ag 3.8/ Cu 0.7
 PACKAGING: TRAYS AND TAPE AND REEL

SEE SHEET 1 EC NO: UCP2011-2778 DRWN: JGREGOR 2011/03/28 CHKD: APPR: JCOMERC 2011/04/06 REV	DESCRIPTION	GENERAL TOLERANCES (UNLESS SPECIFIED)		DIMENSION STYLE		SCALE	DESIGN UNITS	THIRD ANGLE PROJECTION		
			mm	INCH	INCH ONLY		4:1	INCH		
		4 PLACES	± ---	± ---	DRAWN BY	DATE	TITLE			
		3 PLACES	± ---	± .010	JGREGOR	2005/01/27	SEARAY PLUG ASSEMBLY .050 CENTERS			
		2 PLACES	± ---	± .015	JCOMERC					
1 PLACE	± ---	± ---	APPROVED BY	DATE	MOLEX INCORPORATED					
	ANGULAR	± ---°	JCOMERC	2010/03/05	DOCUMENT NO.		SHEET NO.			
DRAFT WHERE APPLICABLE MUST REMAIN WITHIN DIMENSIONS			SIZE	THIS DRAWING CONTAINS INFORMATION THAT IS PROPRIETARY TO MOLEX INCORPORATED AND SHOULD NOT BE USED WITHOUT WRITTEN PERMISSION						
			A	SD-45970-001						
				3 OF 10						

tb_frame_A_P_AM_T
 Rev. E 2006/04/15

5 4 3 2 1

		6	5	4	3	2	1	
DIM P:		2.0 MM	3.0 MM	3.5 MM	2.5 MM	4.5 MM	5.0 MM	7.0 MM
DIM R:		.221	.260	.280	.241	3.19	.339	.418
POSITION	DIM G	MATERIAL NO	MATERIAL NO	MATERIAL NO	MATERIAL NO	MATERIAL NO	MATERIAL NO	MATERIAL NO
19	1.146	45970-0163	OBSOLETE	45970-0363	OBSOLETE	OBSOLETE	OBSOLETE	OBSOLETE
10	0.696	OBSOLETE	OBSOLETE	OBSOLETE	OBSOLETE	OBSOLETE	OBSOLETE	OBSOLETE
20	1.196	OBSOLETE	OBSOLETE	OBSOLETE	OBSOLETE	OBSOLETE	OBSOLETE	OBSOLETE
30	1.696	OBSOLETE	OBSOLETE	OBSOLETE	OBSOLETE	OBSOLETE	OBSOLETE	OBSOLETE
40	2.196	OBSOLETE	OBSOLETE	OBSOLETE	OBSOLETE	OBSOLETE	OBSOLETE	OBSOLETE
50	2.696	OBSOLETE	OBSOLETE	OBSOLETE	OBSOLETE	OBSOLETE	OBSOLETE	OBSOLETE
15	0.946	OBSOLETE	OBSOLETE	OBSOLETE	OBSOLETE	OBSOLETE	OBSOLETE	OBSOLETE
25	1.446	OBSOLETE	OBSOLETE	OBSOLETE	OBSOLETE	OBSOLETE	OBSOLETE	OBSOLETE
35	1.946	OBSOLETE	OBSOLETE	OBSOLETE	OBSOLETE	OBSOLETE	OBSOLETE	OBSOLETE
45	2.446	OBSOLETE	OBSOLETE	OBSOLETE	OBSOLETE	OBSOLETE	OBSOLETE	OBSOLETE

		6	5	4	3	2	1	
DIM P:		2.0 MM	3.0 MM	3.5 MM	2.5 MM	4.5 MM	5.0 MM	7.0 MM
DIM R:		.221	.260	.280	.241	.319	.339	.418
POSITION	DIM G	MATERIAL NO	MATERIAL NO	MATERIAL NO	MATERIAL NO	MATERIAL NO	MATERIAL NO	MATERIAL NO
19	1.146	45970-0167	45970-0267	45970-0367	45970-0467	45970-0567	45970-0667	45970-0767
10	0.696	45970-1167	45970-1267	45970-1367	45970-1467	45970-1567	45970-1667	45970-1767
20	1.196	45970-2167	45970-2267	45970-2367	45970-2467	45970-2567	45970-2667	45970-2767
30	1.696	45970-3167	45970-3267	45970-3367	45970-3467	45970-3567	45970-3667	45970-3767
40	2.196	45970-4167	45970-4267	45970-4367	45970-4467	45970-4567	45970-4667	45970-4767
50	2.696	45970-5167	45970-5267	45970-5367	45970-5467	45970-5567	45970-5667	45970-5767
15	0.946	45970-6167	45970-6267	45970-6367	45970-6467	45970-6567	45970-6667	45970-6767
25	1.446	45970-7167	45970-7267	45970-7367	45970-7467	45970-7567	45970-7667	45970-7767
35	1.946	45970-8167	45970-8267	45970-8367	45970-8467	45970-8567	45970-8667	45970-8767
45	2.446	45970-9167	45970-9267	45970-9367	45970-9467	45970-9567	45970-9667	45970-9767

NOTES:
 1. THIS SHEET CONTAINS THE FOLLOWING OPTIONS
 ROWS: 6
 SOLDER CHARGE: TIN / LEAD, 63/Pb 37
 PACKAGING: TRAYS AND TAPE AND REEL

SEE SHEET 1
 EC NO: UCP2011-2778
 DRWN: JGREGOR 2011/03/28
 CHKD:
 APPR: JCOMERC 2011/04/06

DESCRIPTION
 REV

GENERAL TOLERANCES (UNLESS SPECIFIED)		DIMENSION STYLE INCH ONLY	
	mm	INCH	
4 PLACES	±---	±---	DRAWN BY DATE
3 PLACES	±---	±.010	CHECKED BY DATE
2 PLACES	±---	±.015	APPROVED BY DATE
1 PLACE	±---	±---	JCOMERC 1 2010/03/05
ANGULAR ±---°			

DRAFT WHERE APPLICABLE
 MUST REMAIN
 WITHIN DIMENSIONS

SCALE 4:1	DESIGN UNITS INCH	THIRD ANGLE PROJECTION
TITLE SEARAY PLUG ASSEMBLY .050 CENTERS		
DOCUMENT NO. SD-45970-001		SHEET NO. 4 OF 10

THIS DRAWING CONTAINS INFORMATION THAT IS PROPRIETARY TO MOLEX INCORPORATED AND SHOULD NOT BE USED WITHOUT WRITTEN PERMISSION

tb_frame_A_P_AM_1
 Rev. E 2006/04/15

TRAY PACK PK-45971-001

TAPE AND REEL PACK PK-45971-002

D

C

B

A

D

C

B

A

		6	5	4	3	2	1	
DIM P:		2.0 MM	3.0 MM	3.5 MM	2.5 MM	4.5 MM	5.0 MM	7.0 MM
DIM R:		.221	.260	.280	.241	.319	.339	.418
POSITION	DIM G	MATERIAL NO	MATERIAL NO	MATERIAL NO	MATERIAL NO	MATERIAL NO	MATERIAL NO	MATERIAL NO
19	1.146	45970-0181	OBSOLETE	45970-0381	OBSOLETE	OBSOLETE	OBSOLETE	OBSOLETE
10	0.696	OBSOLETE	OBSOLETE	OBSOLETE	OBSOLETE	OBSOLETE	OBSOLETE	OBSOLETE
20	1.196	OBSOLETE	OBSOLETE	OBSOLETE	OBSOLETE	OBSOLETE	OBSOLETE	OBSOLETE
30	1.696	OBSOLETE	OBSOLETE	OBSOLETE	OBSOLETE	OBSOLETE	OBSOLETE	OBSOLETE
40	2.196	OBSOLETE	OBSOLETE	OBSOLETE	OBSOLETE	OBSOLETE	OBSOLETE	OBSOLETE
50	2.696	OBSOLETE	OBSOLETE	OBSOLETE	OBSOLETE	OBSOLETE	OBSOLETE	OBSOLETE
15	0.946	OBSOLETE	OBSOLETE	OBSOLETE	OBSOLETE	OBSOLETE	OBSOLETE	OBSOLETE
25	1.446	OBSOLETE	OBSOLETE	OBSOLETE	OBSOLETE	OBSOLETE	OBSOLETE	OBSOLETE
35	1.946	OBSOLETE	OBSOLETE	OBSOLETE	OBSOLETE	OBSOLETE	OBSOLETE	OBSOLETE
45	2.446	OBSOLETE	OBSOLETE	OBSOLETE	OBSOLETE	OBSOLETE	OBSOLETE	OBSOLETE

		6	5	4	3	2	1	
DIM P:		2.0 MM	3.0 MM	3.5 MM	2.5 MM	4.5 MM	5.0 MM	7.0 MM
DIM R:		.221	.260	.280	.241	.319	.339	.418
POSITION	DIM G	MATERIAL NO	MATERIAL NO	MATERIAL NO	MATERIAL NO	MATERIAL NO	MATERIAL NO	MATERIAL NO
19	1.146	45970-0185	45970-0285	45970-0385	45970-0485	45970-0585	45970-0685	45970-0785
10	0.696	45970-1185	45970-1285	45970-1385	45970-1485	45970-1585	45970-1685	45970-1785
20	1.196	45970-2185	45970-2285	45970-2385	45970-2485	45970-2585	45970-2685	45970-2785
30	1.696	45970-3185	45970-3285	45970-3385	45970-3485	45970-3585	45970-3685	45970-3785
40	2.196	45970-4185	45970-4285	45970-4385	45970-4485	45970-4585	45970-4685	45970-4785
50	2.696	45970-5185	45970-5285	45970-5385	45970-5485	45970-5585	45970-5685	45970-5785
15	0.946	45970-6185	45970-6285	45970-6385	45970-6485	45970-6585	45970-6685	45970-6785
25	1.446	45970-7185	45970-7285	45970-7385	45970-7485	45970-7585	45970-7685	45970-7785
35	1.946	45970-8185	45970-8285	45970-8385	45970-8485	45970-8585	45970-8685	45970-8785
45	2.446	45970-9185	45970-9285	45970-9385	45970-9485	45970-9585	45970-9685	45970-9785

NOTES:
 1. THIS SHEET CONTAINS THE FOLLOWING OPTIONS
 ROWS: 8
 SOLDER CHARGE: TIN, 95.5/ Ag 3.8/ Cu 0.7
 PACKAGING: TRAYS AND TAPE AND REEL

SEE SHEET 1 EC NO: UCP2011-2778 DRWN: TREGORI 2011/03/28 CHKD: JCOMERC I APPR: JCOMERC I 2011/04/06 DESCRIPTION REV	GENERAL TOLERANCES (UNLESS SPECIFIED)		DIMENSION STYLE INCH ONLY		SCALE 4:1	DESIGN UNITS INCH	THIRD ANGLE PROJECTION	
		mm	INCH	DRAWN BY TREGORI	DATE 2005/01/27	TITLE		
	4 PLACES	± ---	± ---	CHECKED BY JCOMERC I	DATE	SEARAY PLUG ASSEMBLY .050 CENTERS		
	3 PLACES	± ---	± .010	APPROVED BY JCOMERC I	DATE 2010/03/05			
	2 PLACES	± ---	± .015	MOLEX MOLEX INCORPORATED		DOCUMENT NO.	SD-45970-001	
1 PLACE	± ---	± ---	DRAFT WHERE APPLICABLE MUST REMAIN WITHIN DIMENSIONS		SHEET NO. 5 OF 10			

fb_frame_A_P_AM_T
 Rev. E 2006/04/15

5

4

3

2

1

		6	5	4	3	2	1	
DIM P:		2.0 MM	3.0 MM	3.5 MM	2.5 MM	4.5 MM	5.0 MM	7.0 MM
DIM R:		.221	.260	.280	.241	.319	.339	.418
POSITION	DIM G	MATERIAL NO	MATERIAL NO	MATERIAL NO	MATERIAL NO	MATERIAL NO	MATERIAL NO	MATERIAL NO
19	1.146	45970-0183	OBSOLETE	45970-0383	OBSOLETE	OBSOLETE	OBSOLETE	OBSOLETE
10	0.696	OBSOLETE	OBSOLETE	OBSOLETE	OBSOLETE	OBSOLETE	OBSOLETE	OBSOLETE
20	1.196	OBSOLETE	OBSOLETE	OBSOLETE	OBSOLETE	OBSOLETE	OBSOLETE	OBSOLETE
30	1.696	OBSOLETE	OBSOLETE	OBSOLETE	OBSOLETE	OBSOLETE	OBSOLETE	OBSOLETE
40	2.196	OBSOLETE	OBSOLETE	OBSOLETE	OBSOLETE	OBSOLETE	OBSOLETE	OBSOLETE
50	2.696	OBSOLETE	OBSOLETE	OBSOLETE	OBSOLETE	OBSOLETE	OBSOLETE	OBSOLETE
15	0.446	OBSOLETE	OBSOLETE	OBSOLETE	OBSOLETE	OBSOLETE	OBSOLETE	OBSOLETE
25	0.946	OBSOLETE	OBSOLETE	OBSOLETE	OBSOLETE	OBSOLETE	OBSOLETE	OBSOLETE
35	1.446	OBSOLETE	OBSOLETE	OBSOLETE	OBSOLETE	OBSOLETE	OBSOLETE	OBSOLETE
45	1.946	OBSOLETE	OBSOLETE	OBSOLETE	OBSOLETE	OBSOLETE	OBSOLETE	OBSOLETE

		6	5	4	3	2	1	
DIM P:		2.0 MM	3.0 MM	3.5 MM	2.5 MM	4.5 MM	5.0 MM	7.0 MM
DIM R:		.221	.260	.280	.241	.319	.339	.418
POSITION	DIM G	MATERIAL NO	MATERIAL NO	MATERIAL NO	MATERIAL NO	MATERIAL NO	MATERIAL NO	MATERIAL NO
19	1.146	45970-0187	45970-0287	45970-0387	45970-0487	45970-0587	45970-0687	45970-0787
10	0.696	45970-1187	45970-1287	45970-1387	45970-1487	45970-1587	45970-1687	45970-1787
20	1.196	45970-2187	45970-2287	45970-2387	45970-2487	45970-2587	45970-2687	45970-2787
30	1.696	45970-3187	45970-3287	45970-3387	45970-3487	45970-3587	45970-3687	45970-3787
40	2.196	45970-4187	45970-4287	45970-4387	45970-4487	45970-4587	45970-4687	45970-4787
50	2.696	45970-5187	45970-5287	45970-5387	45970-5487	45970-5587	45970-5687	45970-5787
15	0.946	45970-6187	45970-6287	45970-6387	45970-6487	45970-6587	45970-6687	45970-6787
25	1.446	45970-7187	45970-7287	45970-7387	45970-7487	45970-7587	45970-7687	45970-7787
35	1.946	45970-8187	45970-8287	45970-8387	45970-8487	45970-8587	45970-8687	45970-8787
45	2.446	45970-9187	45970-9287	45970-9387	45970-9487	45970-9587	45970-9687	45970-9787

NOTES:
 1. THIS SHEET CONTAINS THE FOLLOWING OPTIONS
 ROWS: 8
 SOLDER CHARGE: TIN / LEAD, 63/Pb 37
 PACKAGING: TRAYS AND TAPE AND REEL

SEE SHEET 1 EC NO: UCP2011-2778 DRWN: JGREGORI 2011/03/28 CHKD: JGREGORI APPR: JCOMERC I 2011/04/06 DESCRIPTION REV	GENERAL TOLERANCES (UNLESS SPECIFIED)	DIMENSION STYLE	SCALE	DESIGN UNITS	THIRD ANGLE PROJECTION
	4 PLACES ± --- ± ---	INCH ONLY	4:1	INCH	
	3 PLACES ± --- ± .010	DRAWN BY	TITLE		
	2 PLACES ± --- ± .015	TGREGORI	SEARAY PLUG ASSEMBLY .050 CENTERS		
1 PLACE ± --- ± ---	CHECKED BY	MOLEX INCORPORATED			
ANGULAR ± ---°	JCOMERC I	DOCUMENT NO. SD-45970-001			
DRAFT WHERE APPLICABLE MUST REMAIN WITHIN DIMENSIONS	APPROVED BY	SHEET NO. 6 OF 10			
	JCOMERC I	THIS DRAWING CONTAINS INFORMATION THAT IS PROPRIETARY TO MOLEX INCORPORATED AND SHOULD NOT BE USED WITHOUT WRITTEN PERMISSION			

tb_frame_A_P_AM_T
 Rev. E 2006/04/15

5 4 3 2 1

		6	5	4	3	2	1	
DIM P:		2.0 MM	3.0 MM	3.5 MM	2.5 MM	4.5 MM	5.0 MM	7.0 MM
DIM R:		.221	.260	.280	.241	.319	.339	.418
POSITION	DIM G	MATERIAL NO	MATERIAL NO	MATERIAL NO	MATERIAL NO	MATERIAL NO	MATERIAL NO	MATERIAL NO
19	1.146	OBSELETE	OBSELETE	OBSELETE	OBSELETE	OBSELETE	OBSELETE	OBSELETE
10	0.696	OBSELETE	OBSELETE	OBSELETE	OBSELETE	OBSELETE	OBSELETE	OBSELETE
20	1.196	OBSELETE	OBSELETE	45970-2311	OBSELETE	OBSELETE	OBSELETE	OBSELETE
30	1.696	OBSELETE	45970-3211	OBSELETE	OBSELETE	OBSELETE	OBSELETE	OBSELETE
40	2.196	OBSELETE	OBSELETE	45970-4311	OBSELETE	OBSELETE	OBSELETE	OBSELETE
50	2.696	OBSELETE	OBSELETE	OBSELETE	OBSELETE	OBSELETE	OBSELETE	OBSELETE
15	0.946	OBSELETE	OBSELETE	OBSELETE	OBSELETE	OBSELETE	OBSELETE	OBSELETE
25	1.446	OBSELETE	OBSELETE	OBSELETE	OBSELETE	OBSELETE	OBSELETE	OBSELETE
35	1.946	OBSELETE	OBSELETE	OBSELETE	OBSELETE	OBSELETE	OBSELETE	OBSELETE
45	2.446	OBSELETE	OBSELETE	OBSELETE	OBSELETE	OBSELETE	OBSELETE	OBSELETE

		6	5	4	3	2	1	9.0 MM	
DIM P:		2.0 MM	3.0 MM	3.5 MM	2.5 MM	4.5 MM	5.0 MM	7.0 MM	9.0 MM
DIM R:		.221	.260	.280	.241	.319	.339	.418	.497
POSITION	DIM G	MATERIAL NO	MATERIAL NO	MATERIAL NO	MATERIAL NO	MATERIAL NO	MATERIAL NO	MATERIAL NO	MATERIAL NO
19	1.146	45970-0115	45970-0215	45970-0315	45970-0415	45970-0515	45970-0615	45970-0715	45970-0915
10	0.696	45970-1115	45970-1215	45970-1315	45970-1415	45970-1515	45970-1615	45970-1715	45970-1915
20	1.196	45970-2115	45970-2215	45970-2315	45970-2415	45970-2515	45970-2615	45970-2715	45970-2915
30	1.696	45970-3115	45970-3215	45970-3315	45970-3415	45970-3515	45970-3615	45970-3715	45970-3915
40	2.196	45970-4115	45970-4215	45970-4315	45970-4415	45970-4515	45970-4615	45970-4715	45970-4915
50	2.696	45970-5115	45970-5215	45970-5315	45970-5415	45970-5515	45970-5615	45970-5715	45970-5915
15	0.946	45970-6115	45970-6215	45970-6315	45970-6415	45970-6515	45970-6615	45970-6715	45970-6915
25	1.446	45970-7115	45970-7215	45970-7315	45970-7415	45970-7515	45970-7615	45970-7715	45970-7915
35	1.946	45970-8115	45970-8215	45970-8315	45970-8415	45970-8515	45970-8615	45970-8715	45970-8915
45	2.446	45970-9115	45970-9215	45970-9315	45970-9415	45970-9515	45970-9615	45970-9715	45970-9915

NOTES:
 1. THIS SHEET CONTAINS THE FOLLOWING OPTIONS
 ROWS: 10
 SOLDER CHARGE: TIN, 95.5/ Ag 3.8/ Cu 0.7
 PACKAGING: TRAYS AND TAPE AND REEL

SEE SHEET 1 EC NO: UCP2011-2778 DRWN: JGREGORI 2011/03/28 CHKD: APPR: JCOMERC I 2011/04/06 REV DESCRIPTION	GENERAL TOLERANCES (UNLESS SPECIFIED)		DIMENSION STYLE		SCALE	DESIGN UNITS	THIRD ANGLE PROJECTION	
			INCH ONLY		4:1	INCH		
			mm	INCH	DRAWN BY	DATE	SEARAY PLUG ASSEMBLY .050 CENTERS MOLEX INCORPORATED	
			4 PLACES ± --- ± ---		JGREGORI	2005/01/27		
			3 PLACES ± --- ± .010		CHECKED BY	DATE		
		2 PLACES ± --- ± .015		JCOMERC I		MOLEX INCORPORATED DOCUMENT NO. SD-45970-001 SHEET NO. 7 OF 10		
		1 PLACE ± --- ± ---		APPROVED BY	DATE			
		ANGULAR ± ---°		JCOMERC I	2010/03/05			
		DRAFT WHERE APPLICABLE MUST REMAIN WITHIN DIMENSIONS		SIZE	THIS DRAWING CONTAINS INFORMATION THAT IS PROPRIETARY TO MOLEX INCORPORATED AND SHOULD NOT BE USED WITHOUT WRITTEN PERMISSION			

		5	4	3	2	1
tb_frame_A_P_AM_T Rev. E 2006/04/15						

		6	5	4	3	2	1		
DIM P:		2.0 MM	3.0 MM	3.5 MM	2.5 MM	4.5 MM	5.0 MM	7.0 MM	
DIM R:		.221	.260	.280	.241	.319	.339	.418	
POSITION	DIM G	MATERIAL NO	MATERIAL NO	MATERIAL NO	MATERIAL NO	MATERIAL NO	MATERIAL NO	MATERIAL NO	
19	1.146	OBSOLETE	OBSOLETE	OBSOLETE	OBSOLETE	OBSOLETE	OBSOLETE	OBSOLETE	
10	0.696	OBSOLETE	OBSOLETE	OBSOLETE	OBSOLETE	OBSOLETE	OBSOLETE	OBSOLETE	
20	1.196	OBSOLETE	OBSOLETE	45970-2313	OBSOLETE	OBSOLETE	OBSOLETE	OBSOLETE	
30	1.696	OBSOLETE	45970-3213	OBSOLETE	OBSOLETE	OBSOLETE	OBSOLETE	OBSOLETE	
40	2.196	OBSOLETE	OBSOLETE	45970-4313	OBSOLETE	OBSOLETE	OBSOLETE	OBSOLETE	
50	2.696	OBSOLETE	OBSOLETE	OBSOLETE	OBSOLETE	OBSOLETE	OBSOLETE	OBSOLETE	
15	0.946	OBSOLETE	OBSOLETE	OBSOLETE	OBSOLETE	OBSOLETE	OBSOLETE	OBSOLETE	
25	1.446	OBSOLETE	OBSOLETE	OBSOLETE	OBSOLETE	OBSOLETE	OBSOLETE	OBSOLETE	
35	1.946	OBSOLETE	OBSOLETE	OBSOLETE	OBSOLETE	OBSOLETE	OBSOLETE	OBSOLETE	
45	2.446	OBSOLETE	OBSOLETE	OBSOLETE	OBSOLETE	OBSOLETE	OBSOLETE	OBSOLETE	

		6	5	4	3	2	1	9.0 MM	
DIM P:		2.0 MM	3.0 MM	3.5 MM	2.5 MM	4.5 MM	5.0 MM	7.0 MM	9.0 MM
DIM R:		.221	.260	.280	.241	.319	.339	.418	.497
POSITION	DIM G	MATERIAL NO	MATERIAL NO	MATERIAL NO	MATERIAL NO	MATERIAL NO	MATERIAL NO	MATERIAL NO	MATERIAL NO
19	1.146	45970-0117	45970-0217	45970-0317	45970-0417	45970-0517	45970-0617	45970-0717	45970-0917
10	0.696	45970-1117	45970-1217	45970-1317	45970-1417	45970-1517	45970-1617	45970-1717	45970-1917
20	1.196	45970-2117	45970-2217	45970-2317	45970-2417	45970-2517	45970-2617	45970-2717	45970-2917
30	1.696	45970-3117	45970-3217	45970-3317	45970-3417	45970-3517	45970-3617	45970-3717	45970-3917
40	2.196	45970-4117	45970-4217	45970-4317	45970-4417	45970-4517	45970-4617	45970-4717	45970-4917
50	2.696	45970-5117	45970-5217	45970-5317	45970-5417	45970-5517	45970-5617	45970-5717	45970-5917
15	0.946	45970-6117	45970-6217	45970-6317	45970-6417	45970-6517	45970-6617	45970-6717	45970-6917
25	1.446	45970-7117	45970-7217	45970-7317	45970-7417	45970-7517	45970-7617	45970-7717	45970-7917
35	1.946	45970-8117	45970-8217	45970-8317	45970-8417	45970-8517	45970-8617	45970-8717	45970-8917
45	2.446	45970-9117	45970-9217	45970-9317	45970-9417	45970-9517	45970-9617	45970-9717	45970-9917

NOTES:
1. THIS SHEET CONTAINS THE FOLLOWING OPTIONS
ROWS: 10
SOLDER CHARGE: TIN / LEAD, 63/Pb 37
PACKAGING: TRAYS AND TAPE AND REEL

SEE SHEET 1 EC NO: UCP2011-2778 DRWN: JGREGOR 2011/03/28 CHKD: APPR: JCOMERC 2011/04/06 DESCRIPTION REV	GENERAL TOLERANCES (UNLESS SPECIFIED)	DIMENSION STYLE INCH ONLY	SCALE 4:1	DESIGN UNITS INCH	THIRD ANGLE PROJECTION
	4 PLACES ± --- ± ---	DRAWN BY JGREGOR DATE 2005/01/27	TITLE		
	3 PLACES ± --- ± .010	CHECKED BY JCOMERC DATE	SEARAY PLUG ASSEMBLY .050 CENTERS MOLEX INCORPORATED		
	2 PLACES ± --- ± .015	APPROVED BY JCOMERC DATE 2010/03/05			
	1 PLACE ± --- ± ---	ANGULAR ± ---°	DOCUMENT NO. SD-45970-001	SHEET NO. 8 OF 10	
DRAFT WHERE APPLICABLE MUST REMAIN WITHIN DIMENSIONS		SIZE A	THIS DRAWING CONTAINS INFORMATION THAT IS PROPRIETARY TO MOLEX INCORPORATED AND SHOULD NOT BE USED WITHOUT WRITTEN PERMISSION		

tb_frame_A_P_AM_T
Rev. E 2006/04/15

5 4 3 2 1

		6	5	4	3	2	1	
DIM P:		2.0 MM	3.0 MM	3.5 MM	2.5 MM	4.5 MM	5.0 MM	7.0 MM
DIM R:		.221	.260	.280	.241	.319	.339	.418
POSITION	DIM G	MATERIAL NO	MATERIAL NO	MATERIAL NO	MATERIAL NO	MATERIAL NO	MATERIAL NO	MATERIAL NO
19	1.146	OBSOLETE	OBSOLETE	OBSOLETE	OBSOLETE	OBSOLETE	OBSOLETE	OBSOLETE
10	0.696	OBSOLETE	OBSOLETE	OBSOLETE	OBSOLETE	OBSOLETE	OBSOLETE	OBSOLETE
20	1.196	OBSOLETE	OBSOLETE	OBSOLETE	OBSOLETE	OBSOLETE	OBSOLETE	OBSOLETE
30	1.696	OBSOLETE	OBSOLETE	OBSOLETE	OBSOLETE	OBSOLETE	OBSOLETE	OBSOLETE
40	2.196	OBSOLETE	OBSOLETE	OBSOLETE	OBSOLETE	OBSOLETE	OBSOLETE	OBSOLETE
50	2.696	OBSOLETE	OBSOLETE	OBSOLETE	OBSOLETE	OBSOLETE	OBSOLETE	OBSOLETE
15	0.946	OBSOLETE	OBSOLETE	OBSOLETE	OBSOLETE	OBSOLETE	OBSOLETE	OBSOLETE
25	1.446	OBSOLETE	OBSOLETE	OBSOLETE	OBSOLETE	OBSOLETE	OBSOLETE	OBSOLETE
35	1.946	OBSOLETE	OBSOLETE	OBSOLETE	OBSOLETE	OBSOLETE	OBSOLETE	OBSOLETE
45	2.446	OBSOLETE	OBSOLETE	OBSOLETE	OBSOLETE	OBSOLETE	OBSOLETE	OBSOLETE

		6	5	4	3	2	1	
DIM P:		2.0 MM	3.0 MM	3.5 MM	2.5 MM	4.5 MM	5.0 MM	7.0 MM
DIM R:		.221	.260	.280	.241	.319	.339	.418
POSITION	DIM G	MATERIAL NO	MATERIAL NO	MATERIAL NO	MATERIAL NO	MATERIAL NO	MATERIAL NO	MATERIAL NO
19	1.146	45970-0125	45970-0225	45970-0325	45970-0425	45970-0525	45970-0625	45970-0725
10	0.696	45970-1125	45970-1225	45970-1325	45970-1425	45970-1525	45970-1625	45970-1725
20	1.196	45970-2125	45970-2225	45970-2325	45970-2425	45970-2525	45970-2625	45970-2725
30	1.696	45970-3125	45970-3225	45970-3325	45970-3425	45970-3525	45970-3625	45970-3725
40	2.196	45970-4125	45970-4225	45970-4325	45970-4425	45970-4525	45970-4625	45970-4725
50	2.696	45970-5125	45970-5225	45970-5325	45970-5425	45970-5525	45970-5625	45970-5725
15	0.946	45970-6125	45970-6225	45970-6325	45970-6425	45970-6525	45970-6625	45970-6725
25	1.446	45970-7125	45970-7225	45970-7325	45970-7425	45970-7525	45970-7625	45970-7725
35	1.946	45970-8125	45970-8225	45970-8325	45970-8425	45970-8525	45970-8625	45970-8725
45	2.446	45970-9125	45970-9225	45970-9325	45970-9425	45970-9525	45970-9625	45970-9725

NOTES:
 1. THIS SHEET CONTAINS THE FOLLOWING OPTIONS
 ROWS: 12
 SOLDER CHARGE: TIN, 95.5/ Ag 3.8/ Cu 0.7
 PACKAGING: TRAYS AND TAPE AND REEL

SEE SHEET 1
 EC NO: UCP2011-2778
 DRWN: GREGORI 2011/03/28
 CHKD:
 APPR: JCOMERC 2011/04/06

DESCRIPTION
 REV

GENERAL TOLERANCES
 (UNLESS SPECIFIED)

	mm	INCH
4 PLACES	± .---	± .---
3 PLACES	± .---	± .010
2 PLACES	± .---	± .015
1 PLACE	± .---	± .---
ANGULAR ± .---°		

DRAFT WHERE APPLICABLE
 MUST REMAIN
 WITHIN DIMENSIONS

DIMENSION STYLE
 INCH ONLY

DRAWN BY	DATE
TGREGORI	2005/01/27
CHECKED BY	DATE
JCOMERC I	
APPROVED BY	DATE
JCOMERC I	2010/03/05

SCALE
 4:1

DESIGN UNITS
 INCH

THIRD ANGLE
 PROJECTION

TITLE
 SEARAY
 PLUG ASSEMBLY
 .050 CENTERS

MOLEX MOLEX INCORPORATED

DOCUMENT NO.
 SD-45970-001

SHEET NO.
 9 OF 10

THIS DRAWING CONTAINS INFORMATION THAT IS PROPRIETARY TO MOLEX
 INCORPORATED AND SHOULD NOT BE USED WITHOUT WRITTEN PERMISSION

tb_frame_A_P_AM_1
 Rev. E 2006/04/15

5 4 3 2 1

		6	5	4	3	2	1	
DIM P:		2.0 MM	3.0 MM	3.5 MM	2.5 MM	4.5 MM	5.0 MM	7.0 MM
DIM R:		.221	.260	.280	.241	.319	.339	.418
POSITION	DIM G	MATERIAL NO	MATERIAL NO	MATERIAL NO	MATERIAL NO	MATERIAL NO	MATERIAL NO	MATERIAL NO
19	1.146	OBSOLETE	OBSOLETE	OBSOLETE	OBSOLETE	OBSOLETE	OBSOLETE	OBSOLETE
10	0.696	OBSOLETE	OBSOLETE	OBSOLETE	OBSOLETE	OBSOLETE	OBSOLETE	OBSOLETE
20	1.196	OBSOLETE	OBSOLETE	OBSOLETE	OBSOLETE	OBSOLETE	OBSOLETE	OBSOLETE
30	1.696	OBSOLETE	OBSOLETE	OBSOLETE	OBSOLETE	OBSOLETE	OBSOLETE	OBSOLETE
40	2.196	OBSOLETE	OBSOLETE	OBSOLETE	OBSOLETE	OBSOLETE	OBSOLETE	OBSOLETE
50	2.696	OBSOLETE	OBSOLETE	OBSOLETE	OBSOLETE	OBSOLETE	OBSOLETE	OBSOLETE
15	0.946	OBSOLETE	OBSOLETE	OBSOLETE	OBSOLETE	OBSOLETE	OBSOLETE	OBSOLETE
25	1.446	OBSOLETE	OBSOLETE	OBSOLETE	OBSOLETE	OBSOLETE	OBSOLETE	OBSOLETE
35	1.946	OBSOLETE	OBSOLETE	OBSOLETE	OBSOLETE	OBSOLETE	OBSOLETE	OBSOLETE
45	2.446	OBSOLETE	OBSOLETE	OBSOLETE	OBSOLETE	OBSOLETE	OBSOLETE	OBSOLETE

		6	5	4	3	2	1	
DIM P:		2.0 MM	3.0 MM	3.5 MM	2.5 MM	4.5 MM	5.0 MM	7.0 MM
DIM R:		.221	.260	.280	.241	.319	.339	.418
POSITION	DIM G	MATERIAL NO	MATERIAL NO	MATERIAL NO	MATERIAL NO	MATERIAL NO	MATERIAL NO	MATERIAL NO
19	1.146	45970-0127	45970-0227	45970-0327	45970-0427	45970-0527	45970-0627	45970-0727
10	0.696	45970-1127	45970-1227	45970-1327	45970-1427	45970-1527	45970-1627	45970-1727
20	1.196	45970-2127	45970-2227	45970-2327	45970-2427	45970-2527	45970-2627	45970-2727
30	1.696	45970-3127	45970-3227	45970-3327	45970-3427	45970-3527	45970-3627	45970-3727
40	2.196	45970-4127	45970-4227	45970-4327	45970-4427	45970-4527	45970-4627	45970-4727
50	2.696	45970-5127	45970-5227	45970-5327	45970-5427	45970-5527	45970-5627	45970-5727
15	0.946	45970-6127	45970-6227	45970-6327	45970-6427	45970-6527	45970-6627	45970-6727
25	1.446	45970-7127	45970-7227	45970-7327	45970-7427	45970-7527	45970-7627	45970-7727
35	1.946	45970-8127	45970-8227	45970-8327	45970-8427	45970-8527	45970-8627	45970-8727
45	2.446	45970-9127	45970-9227	45970-9327	45970-9427	45970-9527	45970-9627	45970-9727

NOTES:
 1. THIS SHEET CONTAINS THE FOLLOWING OPTIONS
 ROWS: 12
 SOLDER CHARGE: TIN / LEAD, 63/Pb 37
 PACKAGING: TRAYS AND TAPE AND REEL

SEE SHEET 1
 EC NO: UCP2011-2778
 DRWN: TREGORI 2011/03/28
 CHKD:
 APPR: JCOMERC 2011/04/06

DESCRIPTION
 REV

GENERAL TOLERANCES (UNLESS SPECIFIED)
 mm INCH
 4 PLACES ± --- ± ---
 3 PLACES ± --- ± .010
 2 PLACES ± --- ± .015
 1 PLACE ± --- ± ---
 ANGULAR ± ---°
 DRAFT WHERE APPLICABLE
 MUST REMAIN
 WITHIN DIMENSIONS

DIMENSION STYLE
 INCH ONLY
 DRAWN BY TREGORI DATE 2005/01/27
 CHECKED BY JCOMERC
 APPROVED BY JCOMERC DATE 2010/03/05

SCALE 4:1
 DESIGN UNITS INCH
 THIRD ANGLE PROJECTION
 TITLE
 SEARAY
 PLUG ASSEMBLY
 .050 CENTERS
 MOLEX INCORPORATED
 DOCUMENT NO. SD-45970-001
 SHEET NO. 10 OF 10
 THIS DRAWING CONTAINS INFORMATION THAT IS PROPRIETARY TO MOLEX INCORPORATED AND SHOULD NOT BE USED WITHOUT WRITTEN PERMISSION

tb_frame_A_P_AM_T
 Rev. E 2006/04/15

5 4 3 2 1