

10 9 8 7 6 5 4 3 2 1

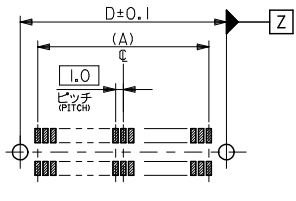

注) NOTES

1. 材質 MATERIAL
ハウジング: ガラス入りLCP、白色、UL94V-0
HOUSING: GLASS F.LCP, WHITE, UL94V-0
ターミナル: 燐青銅 (t=0.2)
TERMINAL: PHOSPHOR BRONZE
2. メッキ仕様 PLATING
接点部: 金メッキ0.25µmMIN.
CONTACT AREA: 0.25µmMIN.
半田付け部: 半田メッキ1.0µmMIN.
SOLDER TAIL AREA: IN-LEAD 1.0µmMIN.
下地メッキ: ニッケルメッキ2.0µmMIN.
UNDER-PLATING: NICKEL 2.0µmMIN.
3. 推奨基板厚 RECOMMENDED PCB THICKNESS
1.0±0.1mm MIN.
4. テールのバラツキ寸法 TAIL COPLANARITY
テールは、Y面を基準とし、上へ0.02下へ0.15の範囲にあり、目付テール平坦度は0.15とする。
TAILS TO BE WITHIN 0.02 UPWARD AND 0.15 DOWNWARD FROM Y-DATUM PLANE, AND TAIL COPLANARITY TO BE 0.15.
5. ロックは、20, 34, 50極に設置する。
LOCK TO BE ADDED TO 20, 34 AND 50 CKTS.

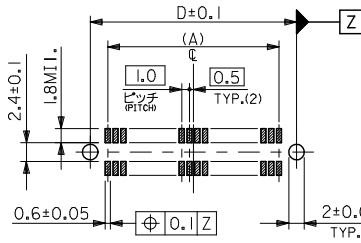
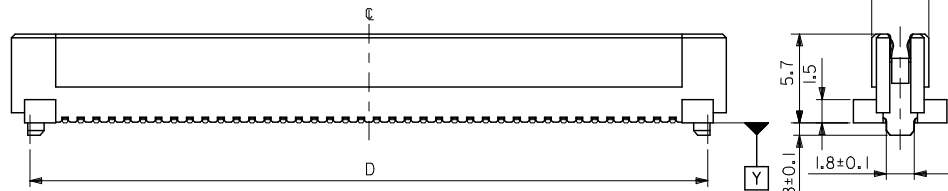
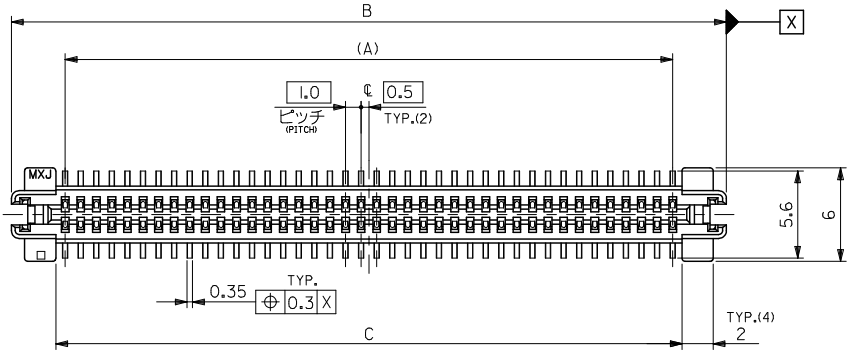
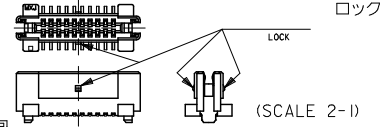

6. 梱包 PACKING
本製品はスティック梱包とし、梱包後のENG. NO. は52584-***9とする。
THIS PRODUCTS TO BE PACKED IN TUBE. ENG. NO. 52584-***9
DO NOT RECOMMEND THE USAGE OF TWO OR MORE OF THESE CONNECTORS BETWEEN A SINGLE PAIR OF P.C.B. BOARD.
7. 同基板内に複数個(2ヶ以上)の使用は避けてください。
DO NOT RECOMMEND THE USAGE OF TWO OR MORE OF THESE CONNECTORS BETWEEN A SINGLE PAIR OF P.C.B. BOARD.

73.5	70.2	75.9	69	52584-1400	140
63.5	60.2	65.9	59	52584-1200	120
36.5	33.2	38.9	32	52584-0660	66
33.5	30.2	35.9	29	52584-0600	60
28.5	25.2	30.9	24	52584-0500	50
20.5	17.2	22.9	16	52584-0340	34
13.5	10.2	15.9	9	52584-0200	20
D	C	B	(A)	ENG. NO.	極数 NO. OF CKTS.

推奨基板寸法 (20, 60, 80, 84, 100, 120, 140極)
RECOMMENDED PCB PATTERN LAYOUT (20,60,80,84,100,120,140 CKTS.)
(SCALE 2-1)

推奨基板寸法 (34, 50, 66極)
RECOMMENDED PCB PATTERN LAYOUT (34,50,66 CKTS.)
(SCALE 2-1)

REVISED EC NO: J DRAWN BY: YOSHIDAM 2008/11/06 CHKD: THARUYAMA 2009/03/23 APPR: THARUYAMA 2009/03/25	GENERAL TOLERANCES (UNLESS SPECIFIED)		DIMENSION STYLE MM ONLY		SCALE 4:1	DESIGN UNITS METRIC	THIRD ANGLE PROJECTION
	10 UNDER	±0.2	DRAWN BY J. MIYAZAWA	DATE	TITLE 1.0 B-T-O-B S/T REC. HSG ASSY		
	10 OVER 30 UNDER	±0.25	CHECKED BY M. SASAO	DATE	MOLEX INCORPORATED DOCUMENT NO. SD-52584-009		
	30 OVER	±0.3	APPROVED BY H. IKESUGI	DATE			
	ANGULAR	±3°	MATERIAL NO.	SEE TABLE	THIS DRAWING CONTAINS INFORMATION THAT IS PROPRIETARY TO MOLEX INCORPORATED AND SHOULD NOT BE USED WITHOUT WRITTEN PERMISSION		
DRAFT WHERE APPLICABLE MUST REMAIN WITHIN DIMENSIONS		SIZE A3					

10 9 8 7 6 5 4 3 2 1

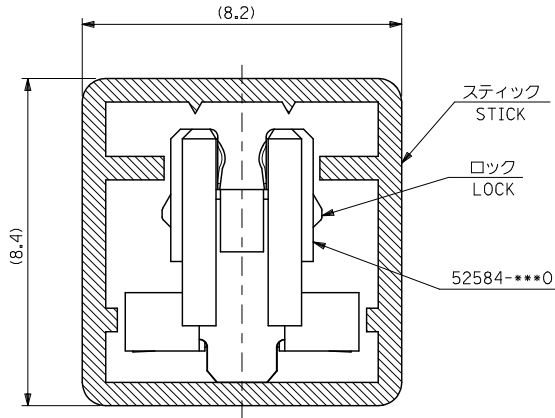

注記
NOTES

1. スティック両端はキャップ止め。
BOTH ENDS WITH CAPS.
2. 全 長: 600±2
TOTAL LENGTH
3. 肉 厚: 0.6±0.2
THICKNESS
4. ロックは、20, 34, 50極に設置。
LOCK TO BE ADDED TO 20, 34
AND 50 CKTS.

8	52584-1209	120
24	52584-0349	34
極数 QUANTITY	ENG. No.	極数 NO. OF CKTS.

REVISED	EC NO:	2008/11/07	GENERAL TOLERANCES (UNLESS SPECIFIED)		DIMENSION STYLE MM ONLY		SCALE 10:1	DESIGN UNITS METRIC	THIRD ANGLE PROJECTION	
	DRW:	J. MIYAZAWA	10 UNDER	± ---	DRAWN BY DATE		TITLE 52584-***0 STICK PACKAGING			
	CHK:	H. IKESUGI	10 OVER 30 UNDER	± ---	CHECKED BY DATE					
	APP:	S. YAMADA	30 OVER	± ---	APPROVED BY DATE		MOLEX INCORPORATED			
REV:		ANGULAR	± --- °	MATERIAL NO.		DOCUMENT NO.				
DRAFT WHERE APPLICABLE MUST REMAIN WITHIN DIMENSIONS			SEE TABLE		SD-52584-010		1 OF 1			
THIS DRAWING CONTAINS INFORMATION THAT IS PROPRIETARY TO MOLEX INCORPORATED AND SHOULD NOT BE USED WITHOUT WRITTEN PERMISSION										

DWG. NO.
SD-53397-***0/52584-***0
SD-53455-***0/52742-***0

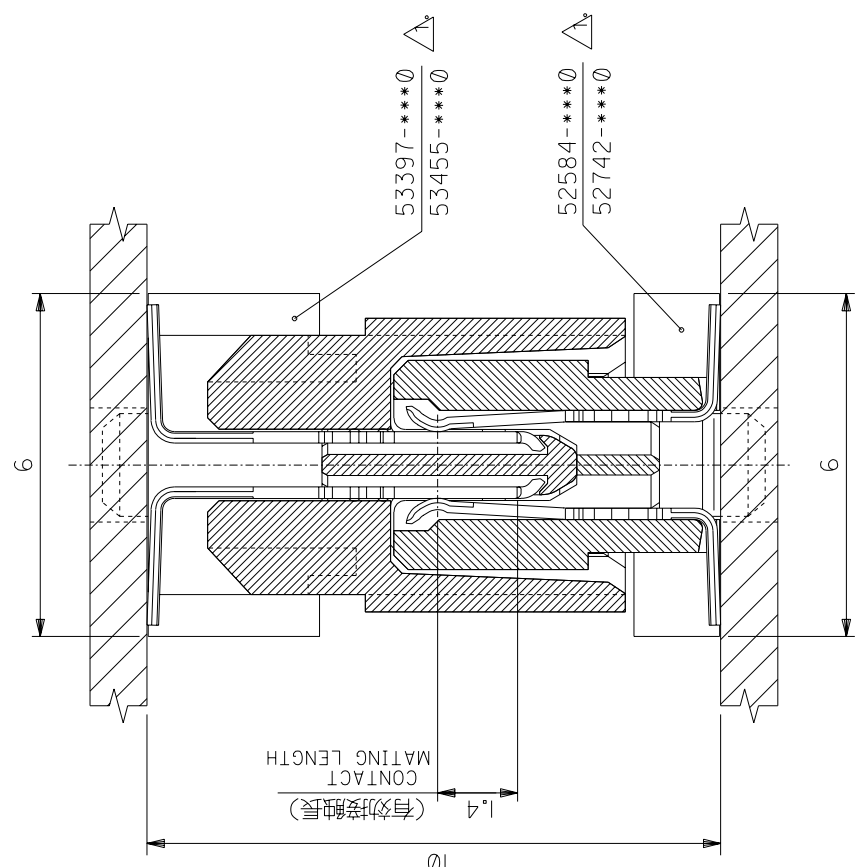

注記 NOTES

- △ 53397-***0 } ナール無し品
52584-***0 } WITHOUT NAIL
- 53455-***0 } ナール有り品
52742-***0 } WITH NAIL

角度 ANGLE	±3°
30°以上 OVER	±0.3
10°以上 未満 UNDER	±0.25
10°未満 UNDER	±0.2
一般公差 GENERAL TOLERANCES	

SCALE DRAWING DIMENSIONS IN METRIC DO NOT SCALE DRAWING

材料 MATERIAL	MOLEX-JAPAN CO.,LTD. 日本モレックス株式会社	
仕上げ FINISH	—	
適用電線範囲 WIRE RANGE	—	
被覆外径 INS. RANGE	—	
DRAWN BY	CHK'D BY	REV
J.M.	M. Naga	A
DATE	DATE	DATE
94/01/27	92/10/27	
DR. DATE	CHK. DATE	SCALE
10-1	10-1	10-1

THIS DRAWING CONTAINS INFORMATION THAT IS PROPRIETARY TO MOLEX(JAPAN) AND SHOULD NOT BE USED WITHOUT WRITTEN PERMISSION
本図面は日本モレックス(株)の所有する情報を含むもので、当社の許可なく複製を禁止する。
EN-01C(032)MX1-33

ZF3110.0313MSG33970.DGN