

10 9 8 7 6 5 4 3 2 1

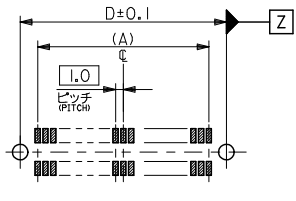

注) NOTES

1. 材質 MATERIAL
ハウジング: ガラス入りLCP、白色、UL94V-0
HOUSING: GLASS F.LCP, WHITE, UL94V-0
ターミナル: 燐青銅 (t=0.2)
TERMINAL: PHOSPHOR BRONZE
2. メッキ仕様 PLATING
接点部: 金メッキ0.25µmMIN.
CONTACT AREA: 0.25µmMIN.
半田付け部: 半田メッキ1.0µmMIN.
SOLDER TAIL AREA: IN-LEAD 1.0µmMIN.
下地メッキ: ニッケルメッキ2.0µmMIN.
UNDER-PLATING: NICKEL 2.0µmMIN.
3. 推奨基板厚 RECOMMENDED PCB THICKNESS
1.0±0.1mm MIN.
4. テールのバラツキ寸法 TAIL COPLANARITY
テールは、Y面を基準とし、上へ0.02下へ0.15の範囲にあり、目付テール平坦度は0.15とする。
TAILS TO BE WITHIN 0.02 UPWARD AND 0.15 DOWNWARD FROM Y-DATUM PLANE, AND TAIL COPLANARITY TO BE 0.15.
5. ロックは、20, 34, 50極に設置する。
LOCK TO BE ADDED TO 20, 34 AND 50 CKTS.

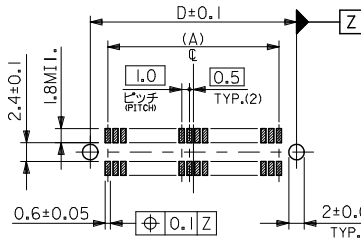
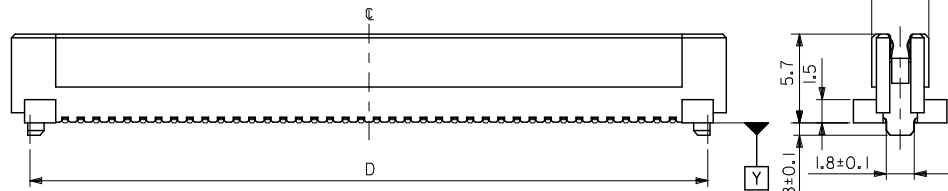
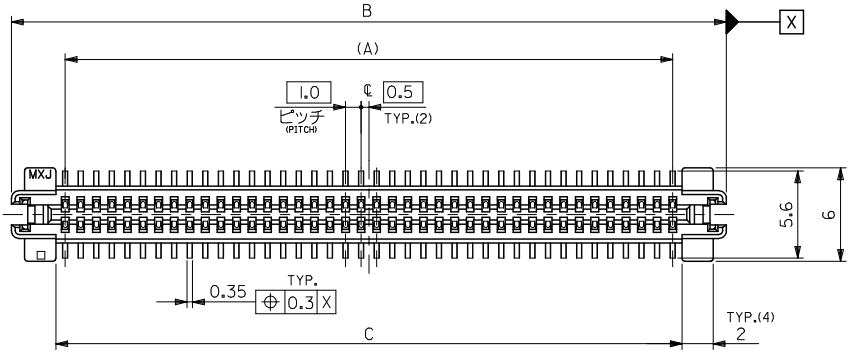
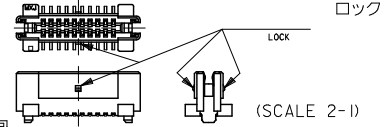

6. 梱包 PACKING
本製品はスティック梱包とし、梱包後のENG. NO. は52584-***9とする。
THIS PRODUCTS TO BE PACKED IN TUBE, ENG. NO. 52584-***9.
7. 同基板内に複数個(2ヶ以上)の使用は避けてください。
DO NOT RECOMMEND THE USAGE OF TWO OR MORE OF THESE CONNECTORS BETWEEN A SINGLE PAIR OF P.C.B. BOARD.

73.5	70.2	75.9	69	52584-1400	140
63.5	60.2	65.9	59	52584-1200	120
36.5	33.2	38.9	32	52584-0660	66
33.5	30.2	35.9	29	52584-0600	60
28.5	25.2	30.9	24	52584-0500	50
20.5	17.2	22.9	16	52584-0340	34
13.5	10.2	15.9	9	52584-0200	20
D	C	B	(A)	ENG. NO.	極数 NO. OF CKTS.

推奨基板寸法 (20, 60, 80, 84, 100, 120, 140極)
RECOMMENDED PCB PATTERN LAYOUT (20,60,80,84,100,120,140 CKTS.)
(SCALE 2-1)

推奨基板寸法 (34, 50, 66極)
RECOMMENDED PCB PATTERN LAYOUT (34,50,66 CKTS.)
(SCALE 2-1)

REVISED EC NO: J DRAWN BY: YOSHIDAM 2008/11/06 CHKD: THARUYAMA 2009/03/23 APPR: THARUYAMA 2009/03/25	GENERAL TOLERANCES (UNLESS SPECIFIED)		DIMENSION STYLE MM ONLY		SCALE 4:1	DESIGN UNITS METRIC	THIRD ANGLE PROJECTION	
	10 UNDER	±0.2	DRAWN BY J. MIYAZAWA		DATE		TITLE 1.0 B-T-O-B S/T REC. HSG ASSY	
	10 OVER 30 UNDER	±0.25	CHECKED BY M. SASAO		DATE		MOLEX INCORPORATED DOCUMENT NO. SD-52584-009	
	30 OVER	±0.3	APPROVED BY H. IKESUGI		DATE			
	ANGULAR	±3°	MATERIAL NO. SEE TABLE		SHEET NO. 1 OF 1		THIS DRAWING CONTAINS INFORMATION THAT IS PROPRIETARY TO MOLEX INCORPORATED AND SHOULD NOT BE USED WITHOUT WRITTEN PERMISSION	
DRAFT WHERE APPLICABLE MUST REMAIN WITHIN DIMENSIONS		SIZE A3						

10 9 8 7 6 5 4 3 2 1

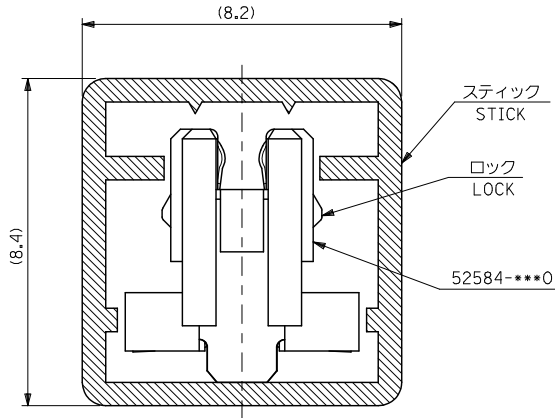

注記
NOTES

1. スティック両端はキャップ止め。
BOTH ENDS WITH CAPS.
2. 全 長: 600±2
TOTAL LENGTH
3. 肉 厚: 0.6±0.2
THICKNESS
4. ロックは、20, 34, 50極に設置。
LOCK TO BE ADDED TO 20, 34
AND 50 CKTS.

8	52584-1209	120
24	52584-0349	34
極数 QUANTITY	ENG. No.	極数 NO. OF CKTS.

REVISED	EC NO:	2008/11/07	GENERAL TOLERANCES (UNLESS SPECIFIED)		DIMENSION STYLE MM ONLY		SCALE 10:1	DESIGN UNITS METRIC	THIRD ANGLE PROJECTION	
	DRW:	J. MIYAZAWA	10 UNDER	± ---	DRAWN BY DATE		TITLE 52584-***0 STICK PACKAGING			
	CHK:	H. IKESUGI	10 OVER 30 UNDER	± ---	CHECKED BY DATE					
	APP:	S. YAMADA	30 OVER	± ---	APPROVED BY DATE		MOLEX INCORPORATED			
REV:		ANGULAR	± --- °	MATERIAL NO.		DOCUMENT NO.				
DRAFT WHERE APPLICABLE MUST REMAIN WITHIN DIMENSIONS			SEE TABLE		SD-52584-010		1 OF 1			
THIS DRAWING CONTAINS INFORMATION THAT IS PROPRIETARY TO MOLEX INCORPORATED AND SHOULD NOT BE USED WITHOUT WRITTEN PERMISSION										

DWG. NO.
SD-53397-***0/52584-***0
SD-53455-***0/52742-***0

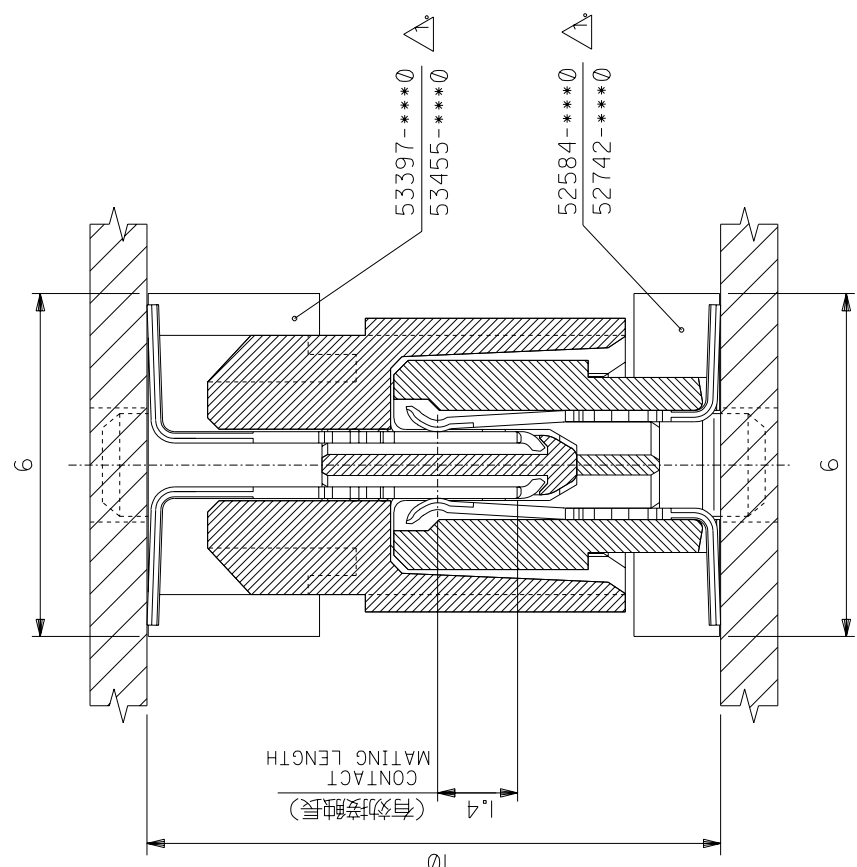

注記 NOTES

- △ 53397-***0 } ナール無し品
52584-***0 } WITHOUT NAIL
- 53455-***0 } ナール有り品
52742-***0 } WITH NAIL

角度	ANGLE	±3°
30°以上	OVER	±0.3
10°以上	OVER	±0.25
10°未満	UNDER	±0.2
一般公差		

DIMENSIONS IN METRIC DO NOT SCALE DRAWING

材料 MATERIAL		MOLEX-JAPAN CO.,LTD. 日本モレックス株式会社	
仕上げ FINISH	—		
適用電線範囲 WIRE RANGE	—		
被覆外径 INS. RANGE	—		
DRAWN BY	CHK'D BY	M. Nagaoka	
194/01/27	J.M.	R. 尺	
APP'D BY	DATE	SCALE 10-1	
92/10/27	M.S.	REV A	
記号 LTR	REVISION RECORD	DWG. NO. SD-53397-***0/52584-***0 SD-53455-***0/52742-***0	
DR. CHK.	DATE	REV A	

THIS DRAWING CONTAINS INFORMATION THAT IS PROPRIETARY TO MOLEX(JAPAN) AND SHOULD NOT BE USED WITHOUT WRITTEN PERMISSION
本図面は日本モレックス(株)の所有する情報を含むもので、当社の許可なく複製を禁止する。
EN-01C(032)MX1-33

ZF3110.0313MSG33970.DGN