

10 9 8 7 6 5 4 3 2 1

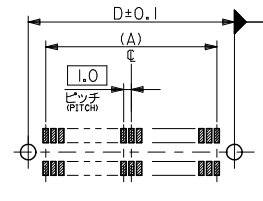
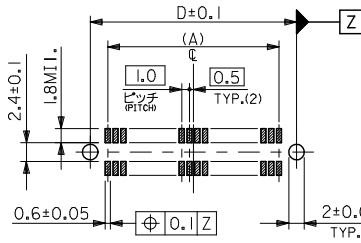
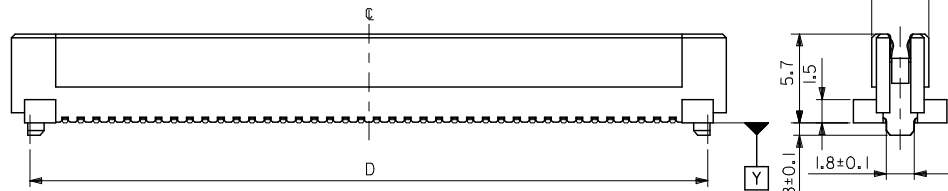
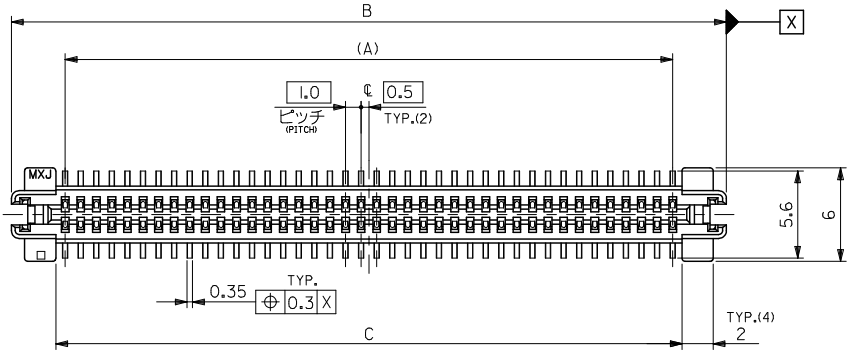

推奨基板寸法 (20, 60, 80, 84, 100, 120, 140極)
RECOMMENDED PCB PATTERN LAYOUT (20,60,80,84,100,120,140 CKTS.)
(SCALE 2-1)

推奨基板寸法 (34, 50, 66極)
RECOMMENDED PCB PATTERN LAYOUT (34,50,66 CKTS.)
(SCALE 2-1)

注) NOTES

- 材質
MATERIAL
ハウジング: ガラス入りLCP, 白色, UL94V-0
HOUSING: GLASS F.LCP, WHITE, UL94V-0
ターミナル: 燐青銅 (t=0.2)
TERMINAL: PHOSPHOR BRONZE
- メッキ仕様
PLATING
接点部: 金メッキ0.25µmMIN.
CONTACT AREA: 0.25µmMIN.
半田付け部: 半田メッキ1.0µmMIN.
SOLDER TAIL AREA: IN-LEAD 1.0µmMIN.
下地メッキ: ニッケルメッキ2.0µmMIN.
UNDER-PLATING: NICKEL 2.0µmMIN.
- 推奨基板厚
RECOMMENDED PCB THICKNESS
1.0±0.1mm MIN.
- テールのバラツキ寸法
TAIL COPLANARITY
テールは、Y面を基準とし、上へ0.02下へ0.15の範囲にあり、目付テール平坦度は0.15とする。
TAILS TO BE WITHIN 0.02 UPWARD AND 0.15 DOWNWARD FROM Y-DATUM PLANE, AND TAIL COPLANARITY TO BE 0.15.
- ロックは、20, 34, 50極に設置する。
LOCK TO BE ADDED TO 20, 34 AND 50 CKTS.

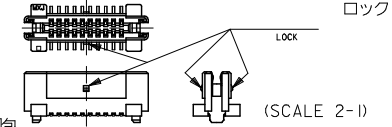

- 梱包
PACKING
本製品はスティック梱包とし、梱包後のENG. NO. は52584-***9とする。
THIS PRODUCTS TO BE PACKED IN TUBE. ENG. NO. 52584-***9
DO NOT RECOMMEND THE USAGE OF TWO OR MORE OF THESE CONNECTORS BETWEEN A SINGLE PAIR OF P.C.B. BOARD.

73.5	70.2	75.9	69	52584-1400	140
63.5	60.2	65.9	59	52584-1200	120
36.5	33.2	38.9	32	52584-0660	66
33.5	30.2	35.9	29	52584-0600	60
28.5	25.2	30.9	24	52584-0500	50
20.5	17.2	22.9	16	52584-0340	34
13.5	10.2	15.9	9	52584-0200	20
D	C	B	(A)	ENG. NO.	極数 NO. OF CKTS.

REVISED EC NO: J DRAWN BY: YOSHIDAM 2008/11/06 CHKD: THARUYAMA 2009/03/23 APPR: THARUYAMA 2009/03/25	GENERAL TOLERANCES (UNLESS SPECIFIED)		DIMENSION STYLE MM ONLY	SCALE 4:1	DESIGN UNITS METRIC	THIRD ANGLE PROJECTION
	10 UNDER	±0.2	DRAWN BY J. MIYAZAWA	DATE	TITLE 1.0 B-T-O-B S/T REC. HSG ASSY	
	10 OVER 30 UNDER	±0.25	CHECKED BY M. SASAO	DATE	MOLEX INCORPORATED DOCUMENT NO. SD-52584-009	
	30 OVER	±0.3	APPROVED BY H. IKESUGI	DATE		
	ANGULAR	±3°	MATERIAL NO.	SEE TABLE	THIS DRAWING CONTAINS INFORMATION THAT IS PROPRIETARY TO MOLEX INCORPORATED AND SHOULD NOT BE USED WITHOUT WRITTEN PERMISSION	
DRAFT WHERE APPLICABLE MUST REMAIN WITHIN DIMENSIONS		SIZE A3				

10 9 8 7 6 5 4 3 2 1

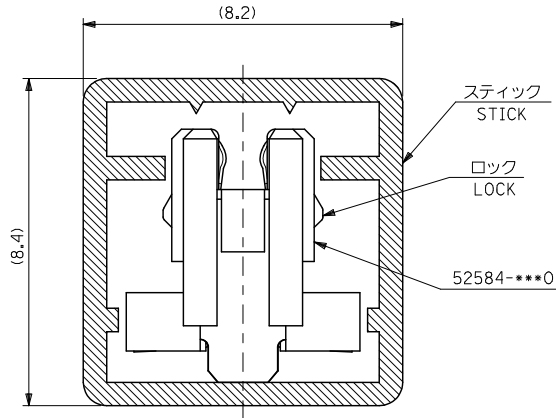

注記
NOTES

1. スティック両端はキャップ止め。
BOTH ENDS WITH CAPS.
2. 全 長: 600±2
TOTAL LENGTH
3. 肉 厚: 0.6±0.2
THICKNESS
4. ロックは、20, 34, 50極に設置。
LOCK TO BE ADDED TO 20, 34
AND 50 CKTS.

8	52584-1209	120
24	52584-0349	34
極数 QUANTITY	ENG. No.	極数 NO. OF CKTS.

REVISED	EC NO:	2008/11/07	GENERAL TOLERANCES (UNLESS SPECIFIED)		DIMENSION STYLE MM ONLY		SCALE 10:1	DESIGN UNITS METRIC	THIRD ANGLE PROJECTION	
	DRW:	J. MIYAZAWA	10 UNDER	± ---	DRAWN BY DATE		TITLE 52584-***0 STICK PACKAGING			
	CHK:	H. IKESUGI	10 OVER 30 UNDER	± ---	CHECKED BY DATE					
	APP:	S. YAMADA	30 OVER	± ---	APPROVED BY DATE		MOLEX INCORPORATED			
REV:		ANGULAR	± --- °	MATERIAL NO.		DOCUMENT NO.				
DRAFT WHERE APPLICABLE MUST REMAIN WITHIN DIMENSIONS			SEE TABLE		SD-52584-010		1 OF 1			
THIS DRAWING CONTAINS INFORMATION THAT IS PROPRIETARY TO MOLEX INCORPORATED AND SHOULD NOT BE USED WITHOUT WRITTEN PERMISSION										

DWG. NO.
SD-53397-***0/52584-***0
SD-53455-***0/52742-***0

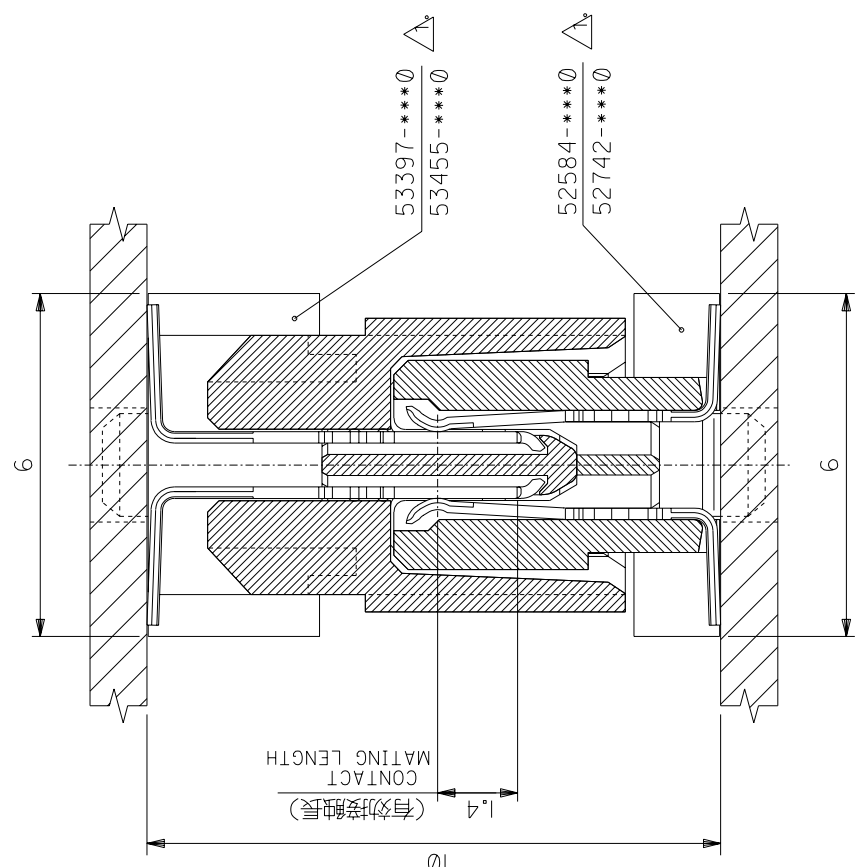

注記 NOTES

- △ 53397-***0 } ネール無し品 WITHOUT NAIL
- 52584-***0 }
- 53455-***0 } ネール有り品 WITH NAIL
- 52742-***0 }

角度	ANGLE	±3°
30°以上	OVER	±0.3
10°以上	OVER	±0.25
10°未満	UNDER	±0.2
一般公差		

DIMENSIONS IN METRIC DO NOT SCALE DRAWING

材料 MATERIAL —
仕上げ FINISH —
適用電線範囲 WIRE RANGE —
被覆外径 INS. RANGE —
DRAWN BY J.M. 194/01/27
CHK'D BY M. Nagaoka
APP'D BY S. Sato
DATE 92/10/27

変更 REVISION	(7400044)	J.M.	194/01/27
新規作成 RELEASED	(1720452)	J.M.	92/10/27
記号 LTR	変更内容	DR.	DATE
		CHK.	SCALE 10-1

モレックス株式会社 MOLEX-JAPAN CO.,LTD.	
REVISE ONLY ON CAD SYSTEM	
TITLE 名称	
I;0 B-T0-B CONNECTOR 嵌合図	
CROSS-SECTION VIEW	
OF MATED CONNECTORS	
DWG. NO.	REV
SD-53397-***0/52584-***0	A
SD-53455-***0/52742-***0	A

THIS DRAWING CONTAINS INFORMATION THAT IS PROPRIETARY TO MOLEX(JAPAN) AND SHOULD NOT BE USED WITHOUT WRITTEN PERMISSION
本図面は日本モレックス(株)の所有する情報を含むもので、当社の許可なく複製を禁止する。
EN-01C(032)MX1-33

ZF3110.0313MSG33970.DGN