

THIS DRAWING IS UNPUBLISHED. RELEASED FOR PUBLICATION BY AMP INCORPORATED. ALL RIGHTS RESERVED. COPYRIGHT 1979

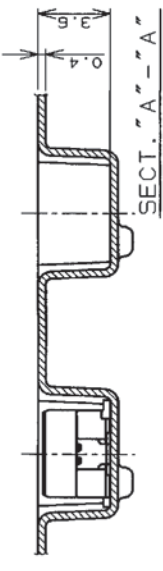
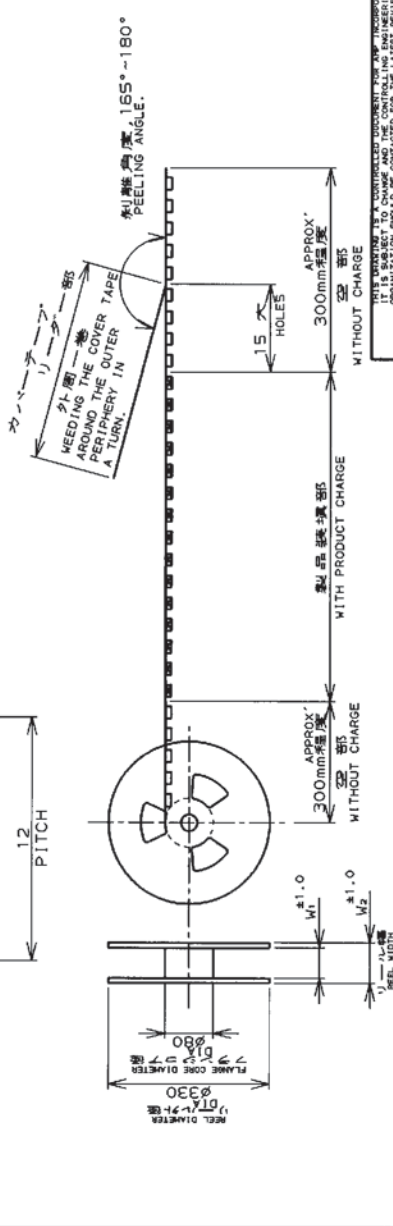
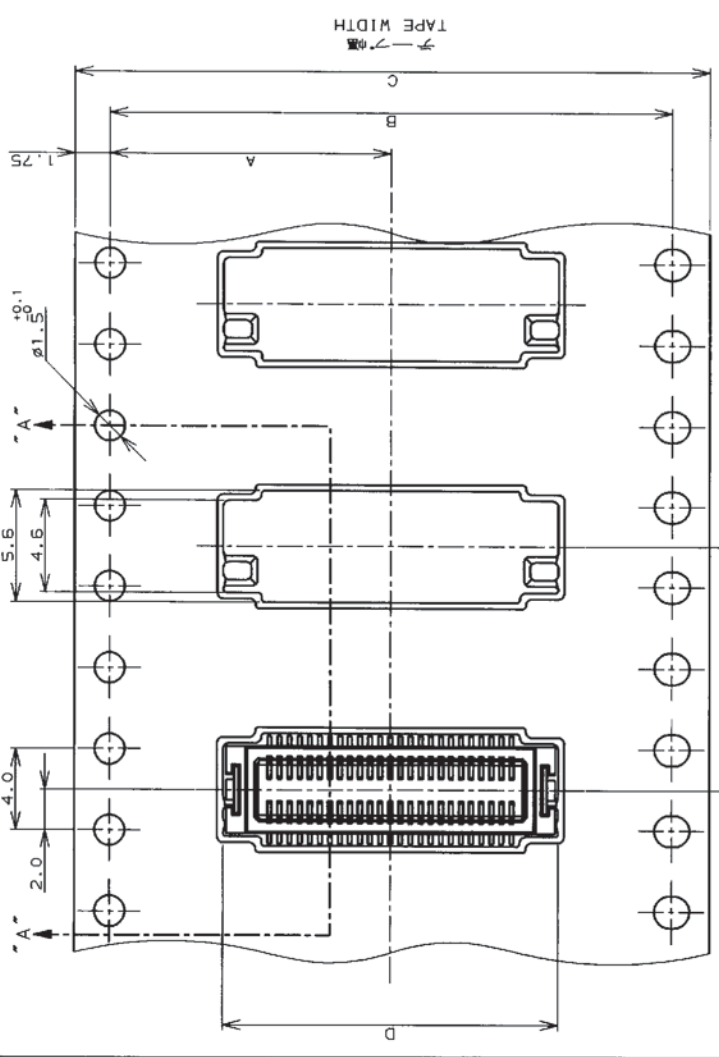

REVISONS			
P	LTR	DESCRIPTION	ECN
0	作成	FJ00-0061-97	2/28/97
A	改訂	FJ00-2247-98	12/3/98
B	改訂	FJ00-2287-98	1/10/98

DATE	DMN	APVD
2/28/97	Y.N	K.A
12/3/98	Y.N	K.A
1/10/98	Y.N	K.A

注記：
 △ 指示穴は 50種品のみ適用。
 NOTE:
 △ THESE HOLES ARE APPLIED TO 50P-os. ONLY.

引出し方向
 TOP OF REEL

36.7	19.1	32	28.4	14.2	50	6-	0	6-	0
20.7	17.5	9.1	16	7.5	1000	20	2-316112-0	2-316117-0	
M ₂	M ₁	D	C	B	A	数量 (ヶ)	極数 (ヶ)	コネクタ型番 (シマ)	リール型番 (シマ)
						qty/REEL	Pop.	CONNECTOR P/N (L/P)	TAPING P/N

INSTRUCTION SHEET 取扱説明書		MIRE RANGE 指定電線断面積		INSULATION DIA 絶縁外径	
411-5808		DMN 2/28/97		Y. NAKAZAWA	
CHK K. ASAKAWA		APVD 4/7/97		KAWASAKI, JAPAN	
NAME KAWASAKI		PRODUCT SPEC 108-5496		ON TAPING (EMB055) 0.5mm PITCH Fine Mate CONN. TAB ASSEMBLY (V-TYPE)	
APPLY TO 108-5496		APPLICATION SPEC 取付適用規格		SIZE (CASE CODE) A3 00779	
WEIGHT		DRAWING NO 316117		RESTRICTED TO	
MATERIAL		FINISH		CUSTOMER DRAWING	
DIRECTIONS 取付時		TOLERANCES UNLESS OTHERWISE SPECIFIED 公差		SCALE 1 OF 2	
DIMENSIONS 寸法		OTHERWISE SPECIFIED 100 ± 0.25 200 ± 0.25 300 ± 0.5 ANGLE ± 0.3°		SHEET 1 OF 2	
MATERIAL		FINISH		REV B	

REVISIONS			
NO.	DESCRIPTION	ECN	DATE
1	SEE SHEET 1 OF 2		

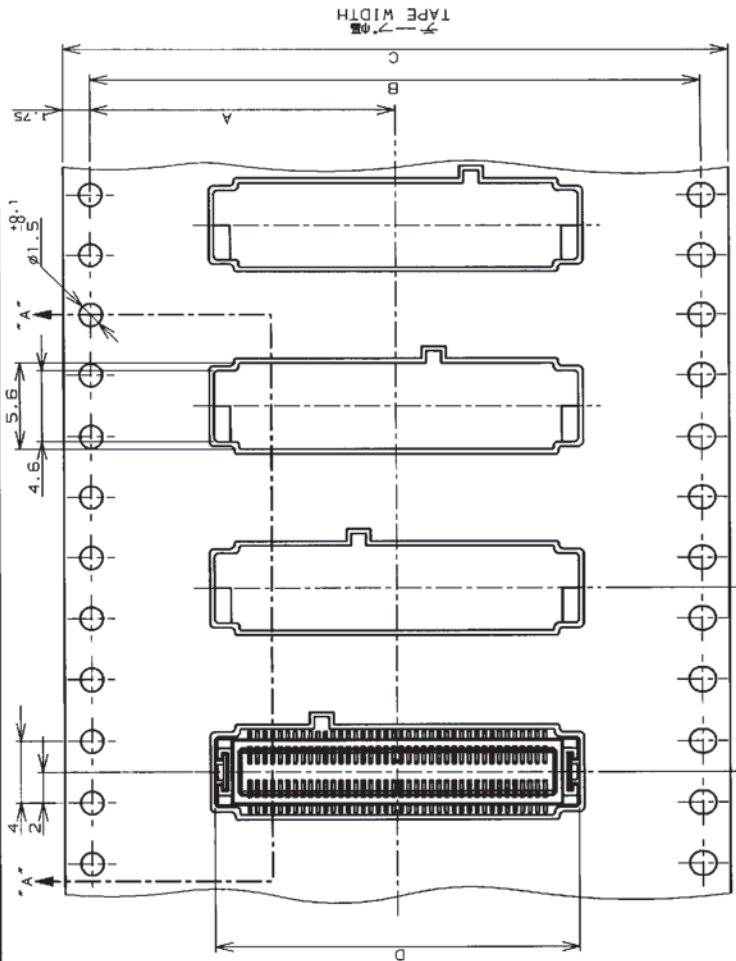

注記：
 △ 指示穴は 60種品のみ適用。
 NOTE:
 △ THESE HOLES ARE APPLIED TO 60Pos. ONLY.

引出し方向
 TOP OF REEL

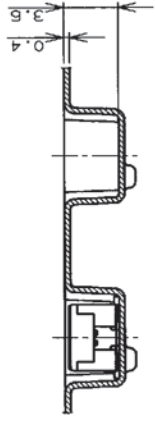

NEEDING TO CHARGE
 AROUND THE COVER TAPE
 PERIPHERY IN
 A TURN.
 剥離角度 155°-180°
 PEELING ANGLE.

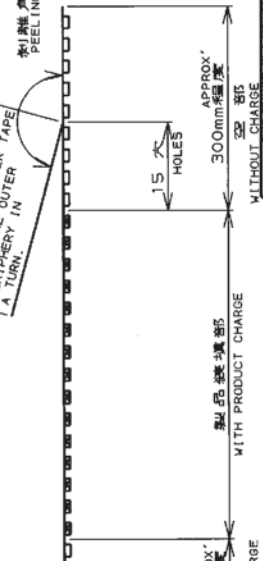
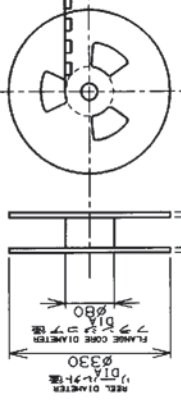

50.5	45.5	24.1	44	40.4	20.2	1000	80	8-316112-0	8-316117-0
W ₂	W ₁	D	C	B	A	数量 (枚)	コネクタ型番 (コネクタ)	コネクタ型番	リール番号
						qty./reel	CONNECTOR P/N (G/P)	コネクタ型番	TAPING P/N

INSTRUCTION SHEET		411-5808	
取扱説明書		取扱説明書	
CHK		Y. NAKAZAWA	
DATE		12/3/98	
NAME		K. ASAKAWA	
PRODUCT SPEC		108-5496	
TAPING SPEC		108-5496	
TAPING SPEC		108-5496	
NET WT		A3 00779	
CUSTOMER DRAWING		SCALE 1:1	
		SHEET 2 OF 2	

TOLERANCES UNLESS OTHERWISE SPECIFIED	
一般公差	10% ±0.2
寸法	20 ±0.25
100%	30 ±0.3
角度	±0.3
DIMENSIONS IN mm	
FINISH 仕上	
MATERIAL 材料	
ON TAPING (EMBOSS)	
0.5mm PITCH Fine Mate CONN.	
TAB ASSEMBLY (V-TYPE)	
SIZE (CAGE CODE) 組立番号	
A3 00779 C=316117	
RESTRICTED TO	

AMP1470-19 REV 10/93
 ptj00006