

THIS DRAWING IS UNPUBLISHED. RELEASED FOR PUBLICATION JUN. 1996.
 © COPYRIGHT 1996 BY TYCO ELECTRONICS CORPORATION. ALL RIGHTS RESERVED.

P		LTR		REVISIONS		DATE	DWN	APVD
C		REVISED		DESCRIPTION		15MAY08	T.T	T.F
				ECR-08-012332				

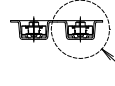

WEEDING THE COVER TAPE AROUND THE OUTER PERIPHERY IN A TURN.

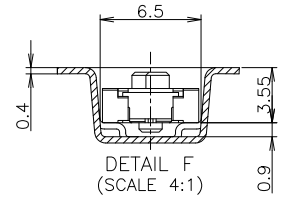
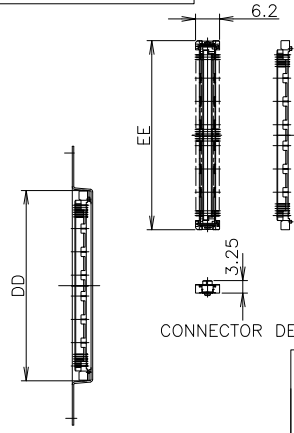
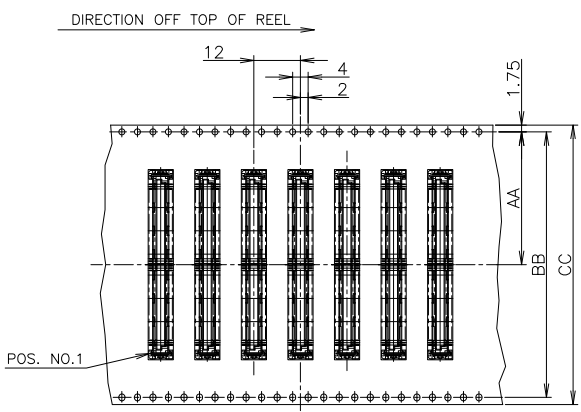
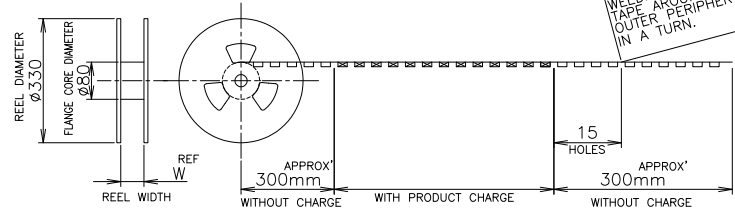

SEALANT	TOOLING STATUS	QTY.	FINISH	W	EE	DD	CC	BB	AA	POS.	PART NO.
NOT AVAILABLE	1000	△		77.5	54.7	55	72	68.4	34.2	160	6-5353190-1
AVAILABLE				77.5	48.7	49	72	68.4	34.2	140	6-
NOT AVAILABLE				61.5	42.7	43	56	52.4	26.2	120	5-
AVAILABLE				61.5	36.7	37	56	52.4	26.2	100	5-
NOT AVAILABLE				61.5	33.7	34	56	52.4	26.2	90	5-
AVAILABLE				49.5	30.7	31	44	40.4	20.2	80	5-
NOT AVAILABLE				49.5	27.7	28	44	40.4	20.2	70	5-
AVAILABLE				49.5	24.7	25	44	40.4	20.2	60	5-
NOT AVAILABLE				37.5	21.7	22	32	28.4	14.2	50	5-
AVAILABLE				37.5	18.7	19	32	28.4	14.2	40	5-
NOT AVAILABLE	1000	△		29.5	15.7	16	24	—	11.5	30	5-5353190-1
AVAILABLE	1000	△		77.5	48.7	49	72	68.4	34.2	140	4-5353190-0
AVAILABLE				61.5	36.7	37	56	52.4	26.2	100	3-
NOT AVAILABLE				77.5	54.7	55	72	68.4	34.2	160	1-
AVAILABLE				77.5	48.7	49	72	68.4	34.2	140	1-
NOT AVAILABLE				61.5	42.7	43	56	52.4	26.2	120	-9
AVAILABLE				61.5	36.7	37	56	52.4	26.2	100	-8
NOT AVAILABLE				61.5	33.7	34	56	52.4	26.2	90	-7
AVAILABLE				49.5	30.7	31	44	40.4	20.2	80	-6
NOT AVAILABLE				49.5	27.7	28	44	40.4	20.2	70	-5
AVAILABLE				49.5	24.7	25	44	40.4	20.2	60	-4
NOT AVAILABLE				37.5	21.7	22	32	28.4	14.2	50	-3
AVAILABLE				37.5	18.7	19	32	28.4	14.2	40	-2
NOT AVAILABLE	1000	△		29.5	15.7	16	24	—	11.5	30	5353190-1

THIS DRAWING IS A CONTROLLED DOCUMENT.

DIMENSIONS: 單位: 毫米 mm	TOLERANCES UNLESS OTHERWISE SPECIFIED: 一般公差	DWN LEO ZHOU 16NOV04	CHK STEVEN YAO 16NOV04	Tyco Electronics Tyco Electronics Corporation Kawasaki, Japan	
0 PLC ±0.2 1 PLC ±0.2 2 PLC ±0.2 3 PLC ±0.2 4 PLC ±0.2 FINISH 仕上げ ±0.5'		APVD IENOMOTO 16NOV04	NAME 名稱 IENOMOTO	EMBOSS ASSY FH 0.6BTB CONNECTOR REC 4H WITH G-CONTACT	
MATERIAL 材料		APPLICATION SPEC 取付適用規格 14-5255	SIZE A3	CAGE CODE 00779	DRAWING NO 5353190
		WEIGHT	CUSTOMER DRAWING		RESTRICTED TO
			SCALE 尺度 1:1	SHEET 1 of 3	REV C

4

3

2

1

THIS DRAWING IS UNPUBLISHED. RELEASED FOR PUBLICATION JUN. 1996.
 © COPYRIGHT 1996 BY TYCO ELECTRONICS CORPORATION. ALL RIGHTS RESERVED.

LOC	DIST	REVISIONS					
J		P	LTR	DESCRIPTION	DATE	DWN	APVD
		-	-	SEE SHEET 1	-	-	-

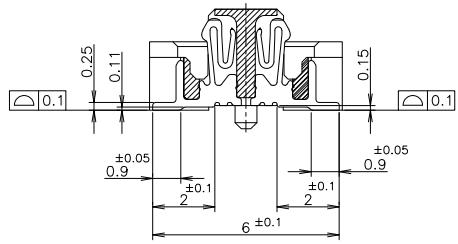
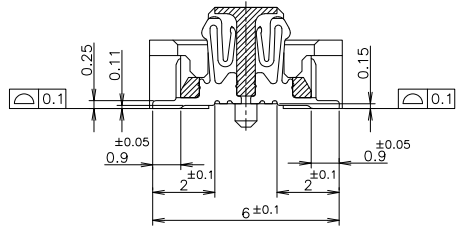
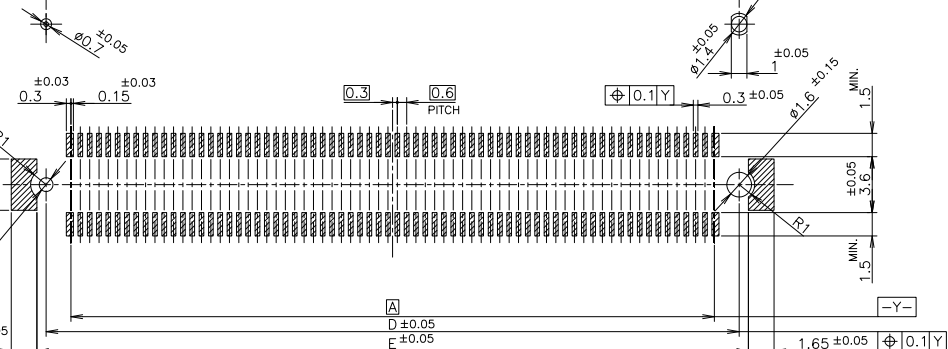
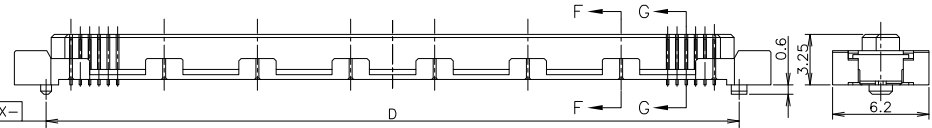
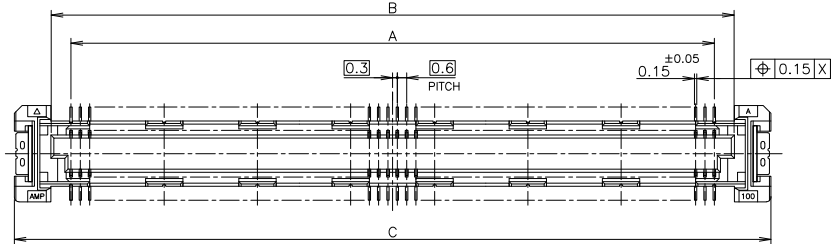

45.8	44.6	48.7	44	41.4	140	4-5353190-0		
33.8	32.6	36.7	32	29.4	100	3-	↑	-8
51.8	50.6	54.7	50	47.4	160	1-		-1 & 6-5353190-1
45.8	44.6	48.7	44	41.4	140	1-		-0 & 6-
39.8	38.6	42.7	38	35.4	120			-9 & 5-
33.8	32.6	36.7	32	29.4	100			-8 & 5-
30.8	29.6	33.7	29	26.4	90			-7 & 5-
27.8	26.6	30.7	26	23.4	80			-6 & 5-
24.8	23.6	27.7	23	20.4	70			-5 & 5-
21.8	20.6	24.7	20	17.4	60			-4 & 5-
18.8	17.6	21.7	17	14.4	50			-3 & 5-
15.8	14.6	18.7	14	11.4	40			-2 & 5-
12.8	11.6	15.7	11	8.4	30			5353190-1 & 5-5353190-1
E	D	C	B	A	POS	PART NO.		

REFERENCE P.C.BOARD LAYOUT

THIS DRAWING IS A CONTROLLED DOCUMENT.

DIMENSIONS: 単位: 純 mm	TOLERANCES UNLESS OTHERWISE SPECIFIED: 公差表
	0 PLC ±0.3
	1 PLC ±0.3
	2 PLC ±0.3
	3 PLC ±0.3
	4 PLC ±0.3
	ANGLES ±3°
MATERIAL 材料	FINISH 仕上

DWN	CHK
APVD	PRODUCT SPEC
APPLICATION SPEC	WEIGHT
CUSTOMER DRAWING	

Tyco Electronics Tyco Electronics Corporation
Kawasaki, Japan

EMBOSS ASSY
FH 0.6BTB CONNECTOR
REC 4H WITH G-CONTACT

SIZE: A3 CAGE CODE: 00779 DRAWING NO: 5353190

SCALE: 4:1 SHEET: 2 OF 3 REV: C

AMP 1470-19 REV 31MAR2000

4

3

2

1

THIS DRAWING IS UNPUBLISHED. RELEASED FOR PUBLICATION JUN. 1996.
 © COPYRIGHT 1996 BY TYCO ELECTRONICS CORPORATION. ALL RIGHTS RESERVED.

LOC	DIST	REVISIONS			
J		変更	DATE	DWN	APVD
		DESCRIPTION			
		SEE SHEET 1			

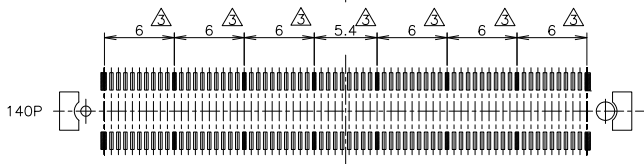
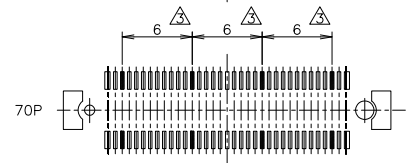
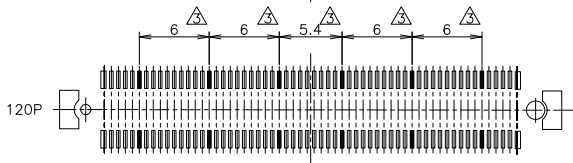
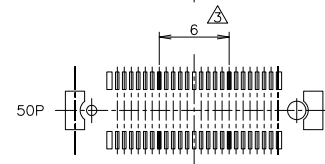
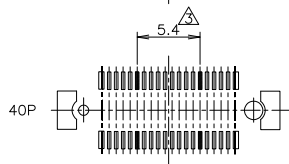
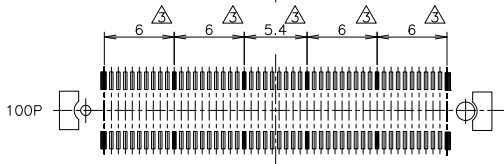
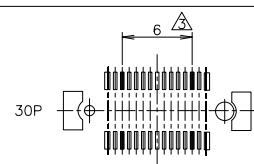
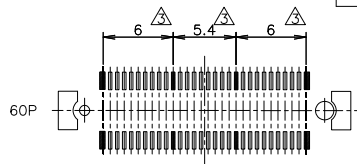
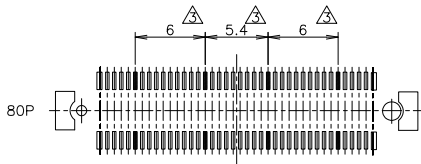

- △ MATERIAL : HOUSING : HIGH TEMP THERMO PLASTIC, UL94V-0
CONTACT : COPPER ALLOY
- △ FINISH : UNDER PL Ni 0.0013mm MIN ALL OVER.
CONTACT AREA 0.0002mm MIN Au PL.
SOLDERING AREA: SIGNAL POS 0.00005mm MIN Au PL.
GROUND POS 0.001mm MIN TIN PL.
- △ THIS POSITION IS GROUND CIRCUIT.
- △ PACKING ASSY DWG SEE SHEET 1.
- △ THIS PRODUCT WAS COATED BY FLUX-PENETRATION
-INHIBITING AGENT.
- △ FINISH : UNDER PL Ni 0.0013mm MIN ALL OVER.
CONTACT AREA 0.00076mm MIN Au PL.
SOLDERING AREA: SIGNAL POS 0.00005mm MIN Au PL.
GROUND POS 0.001mm MIN TIN PL.

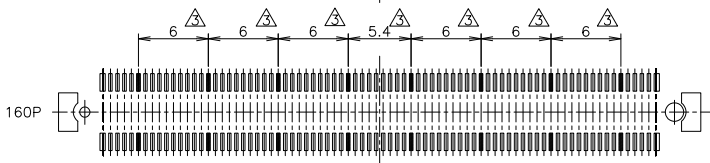

THIS DRAWING IS A CONTROLLED DOCUMENT.		DWN	Tyco Electronics		Tyco Electronics Corporation Kawasaki, Japan
DIMENSIONS: 単位: 純 mm		CHK	NAME 名称		EMBOSS ASSY
TOLERANCES UNLESS OTHERWISE SPECIFIED: 数公差		APVD	PRODUCT SPEC 製品規格		FH 0.6BTB CONNECTOR
0 PLC ± 0.3 1 PLC ± 0.3 2 PLC ± 0.3 3 PLC ± 0.3 4 PLC ± 0.3 ANGLES ± 0°		APPLICATION SPEC 取付適用規格	SIZE	CAGE CODE	DRAWING NO 番号
MATERIAL 材料	FINISH 仕上	WEIGHT	A3	00779	C-5353190
CUSTOMER DRAWING			SCALE 尺度	3:1	SHEET 3 of 3
					REV C

AMP 1470-19 REV 31MAR2000