

4

3

2

1

THIS DRAWING IS UNPUBLISHED. RELEASED FOR PUBLICATION
 COPYRIGHT 19 BY AMP INCORPORATED. ALL RIGHTS RESERVED.

LOC	DIST	REVISIONS			
F	LTR	DESCRIPTION	DATE	OWN	APVD
DY	-	01 REVISED PER ECR-06-029208	14DEC06	SYJ	LSF

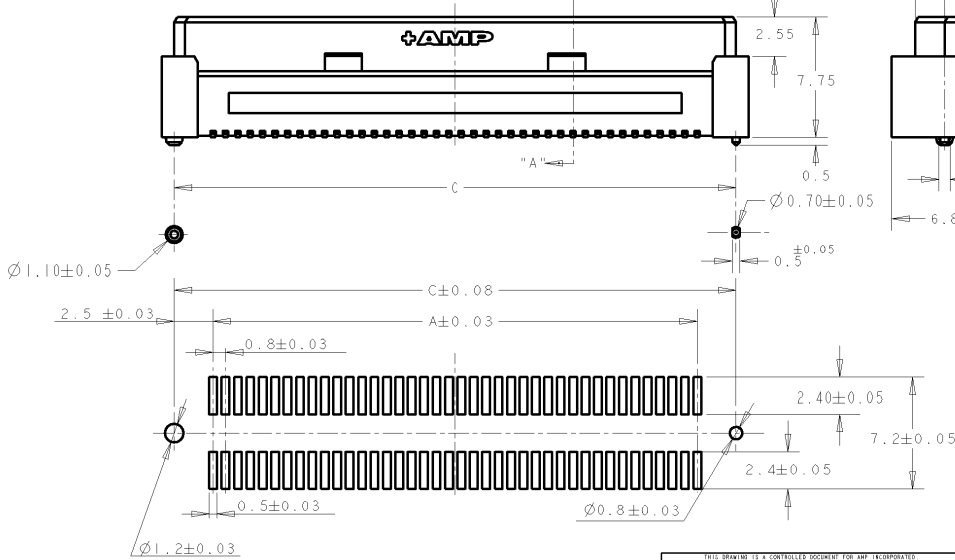
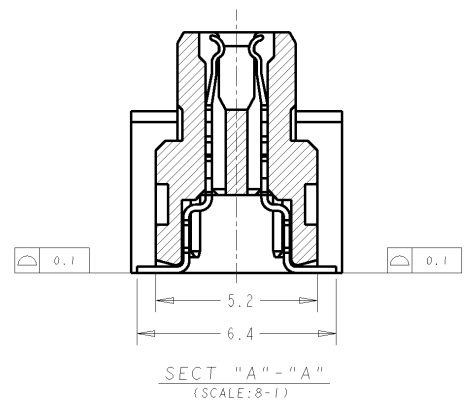
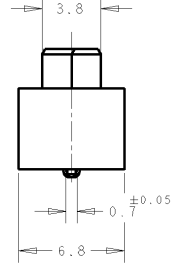
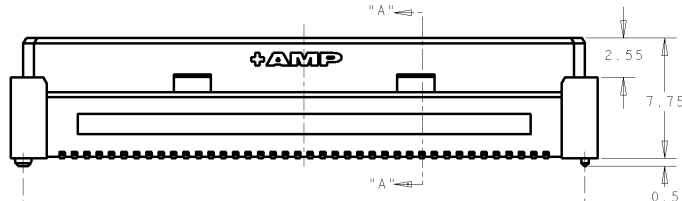
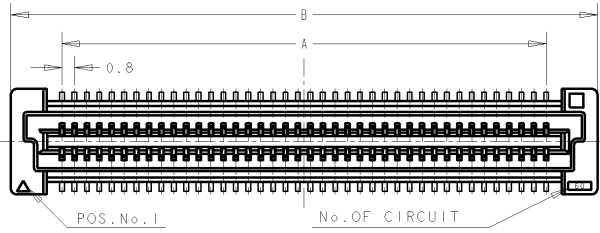

- NOTES:
- △ MATERIAL: HOUSING: L.C.P. (HIGH TEMP THERMO PLASTIC)
UL 94V-0, NATURAL.
CONTACT: BERYLLIUM COPPER.
 - △ FINISH: CONTACT AREA: 0.00076 MIN GOLD ON
0.0013 MIN ALL OVER NICKEL.
SOLDERING AREA: 0.002 MIN MATTE-TIN.
 - 3. POSITION SERIES: SEE TABLE. (SHEET 2)
 - 4. CONN STACK HEIGHT COMBINE OF PLUG "Y" H VS REC "X" H.
STACK HEIGHT = Y + X - 5

P/N SEE SHEET 2 OF 2

RECOMMENDED P.C. BOARD LAYOUT

<small>THIS DRAWING IS A CONTROLLED DOCUMENT FOR AMP INCORPORATED IT IS SUBJECT TO CHANGE AND THE CONFORMING MANUFACTURING ORGANIZATION SHOULD BE CONTACTED FOR THE LATEST REVISION.</small>		DWN FLORENCE TAN 14SLP04 CHK ERIC TNG APVD SE LEONG PRODUCT SPEC 108-5390 APPLICATION SPEC 114-5254 WEIGHT - CUSTOMER DRAWING	tyco Electronics Tyco Electronics (Singapore) Pte. Ltd.
DIMENSIONS: mm 	TOLERANCES UNLESS OTHERWISE SPECIFIED: 0 PLC ± 1 PLC ±0.3 2 PLC ±0.25 3 PLC ±0.2 4 PLC ± ANGLES ±°	NAME RECEPTACLE ASSEMBLY 9H TYPE 30Au (0.5 BOSS LENGTH) FOR FH 0.8mm PITCH B-T-B CONNECTOR SIZE A3 CAGE CODE 00779 DRAWING NO. 5084613 SCALE 4:1 SHEET 1 OF 2 REV 01	MATERIAL 1 FINISH 2

LOC	DIST	REVISIONS			
F	LTR	DESCRIPTION	DATE	OWN	APVD
1		SEE SHEET 1 OF 2			

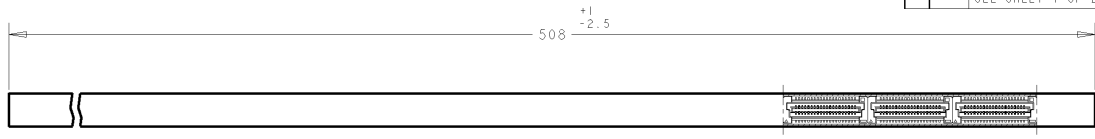

SECT "A" - "A"



SECT "B" - "B"

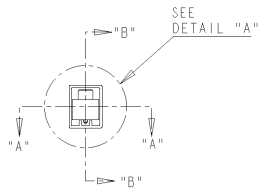

REC ASS'Y (H=9mm), 0.8mm BTB STACKING CONN

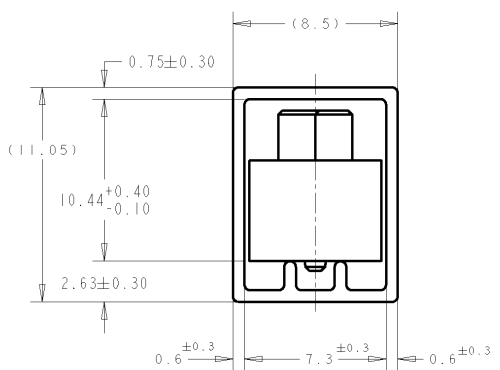

DETAIL "A"
 (SCALE 5-1)

AVAILABLE	84.20	85.80	79.20	200	1-	-0
	76.20	77.80	71.20	180		-9
	68.20	69.80	63.20	160		-8
	60.20	61.80	55.20	140		-6
	52.20	53.80	47.20	120		-5
	44.20	45.80	39.20	100		-4
	36.20	37.80	31.20	80		-3
	28.20	29.80	23.20	60		-2
	20.20	21.80	15.20	40		-1
STATUS	C	B	A	POS.		PART No.

<small>THIS DRAWING IS A CONTROLLED DOCUMENT FOR AMP INCORPORATED IT IS SUBJECT TO CHANGE AND THE CONFORMING DRAWING OR ORGANIZATION SHOULD BE CONTACTED FOR THE LATEST REVISION.</small>		DWN FLORENCE TAN CHK ERIC TNG APVD SEI LIONG	14SLP04 tyco Electronics Tyco Electronics (Singapore) Pte. Ltd.
DIMENSIONS: mm 	TOLERANCES UNLESS OTHERWISE SPECIFIED: 0 PLC ± 1 PLC ±0.3 2 PLC ±0.25 3 PLC ±0.2 4 PLC ± ANGLES ±°	NAME RECEPTACLE ASSEMBLY 9H TYPE 30Au (0.5 BOSS LENGTH) FOR FH 0.8mm PITCH B-T-B CONNECTOR	DRAWING NO 5084613
MATERIAL 	FINISH 	APPLICATION SPEC 108-5390	SIZE A3
		WEIGHT -	CAGE CODE 00779
		CUSTOMER DRAWING	SCALE 4:1 SHEET 2 OF 2 REV 01