

DWG. NO. SD-54363-038

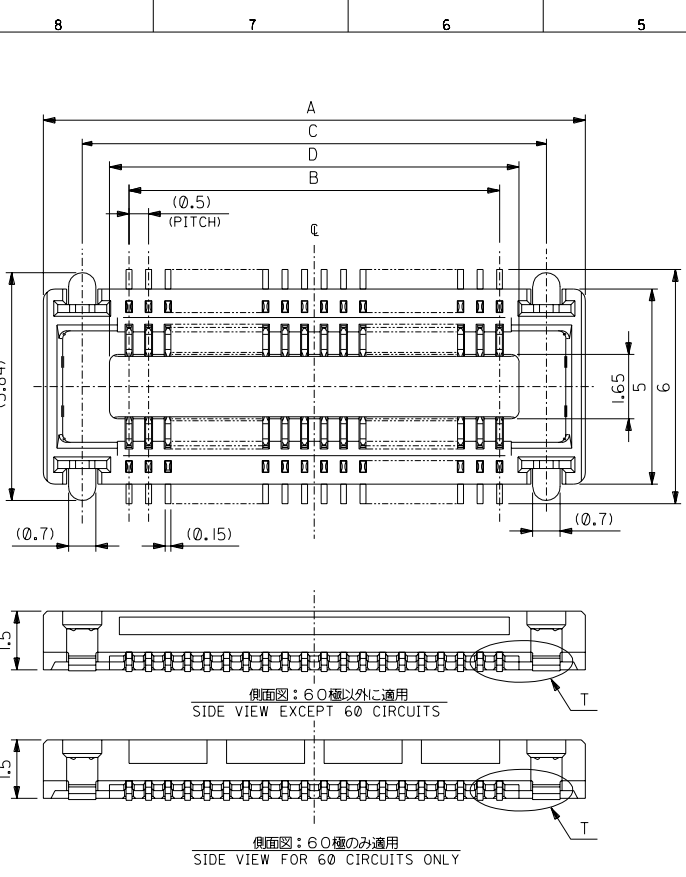

注記 NOTES:

1. 材質 MATERIAL
ハウジング: LCP (液晶ポリマー)、ガラス充填、黒色、UL94V-0
HOUSING: LCP (LIQUID CRYSTAL POLYMER), GLASS FILLED, BLACK, UL94V-0
ターミナル: 銅合金 (t=0.15)
TERMINAL: COPPER ALLOY (t=0.15)
ネイル: 銅合金 (t=0.2)
NAIL: COPPER ALLOY (t=0.2)
2. メッキ仕様 PLATING
ターミナル TERMINAL
接点部: 金メッキ 0.25マイクロメートル以上
CONTACT AREA: GOLD 0.25 MICROMETER MINIMUM
半田付テール: 金メッキ 0.4マイクロメートル以下
SOLDER TAIL AREA: GOLD 0.4 MICROMETER MAXIMUM
下地メッキ: ニッケルメッキ 1.5マイクロメートル以上
UNDER PLATING: NICKEL 1.5 MICROMETER MINIMUM
ネイル NAIL
銅メッキ 3.0マイクロメートル以上
Cu 3.0 MICROMETER MINIMUM
下地メッキ: ニッケルメッキ 1.0マイクロメートル以上
UNDER PLATING: Ni 1.0 MICROMETER MINIMUM
3. テール平坦度は、0.08ミリメートル以下。テールとネイルを併せた平坦度は、0.1ミリメートル以下。
TAIL COPPLANARITY TO BE 0.08 MAXIMUM. TAILS AND NAILS COPPLANARITY TO BE 0.1 MAXIMUM.
4. 嵌合相手: 55299-**** (H=3mm)
MATED CONN.: 55299-**** (H=3mm)
55201-****, 55650-**** (H=2mm)
5. この製品は54363-**01, (エンボス梱包品 54363-**08)の給付品です。
THIS PRODUCT IS 'LEAD FREE' OF 54363-***01, (EMBOSSED TAPE PKG 54363-***08)

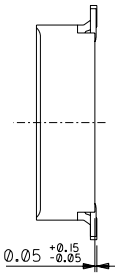

側面図: 60極以外に適用
SIDE VIEW EXCEPT 60 CIRCUITS

側面図: 60極のみ適用
SIDE VIEW FOR 60 CIRCUITS ONLY

40.5	41.9	39.5	43.9	54363-1678	54363-1671	160	—
35.5	36.9	34.5	38.9	54363-1478	54363-1471	140	○
30.5	31.9	29.5	33.9	54363-1278	54363-1271	120	○
28	29.4	27	31.4	54363-1178	54363-1171	110	○
25.5	26.9	24.5	28.9	54363-1078	54363-1071	100	○
23	24.4	22	26.4	54363-0978	54363-0971	90	—
20.5	21.9	19.5	23.9	54363-0878	54363-0871	80	○
18	19.4	17	21.4	54363-0778	54363-0771	70	○
15.5	16.9	14.5	18.9	54363-0678	54363-0671	60	○
13	14.4	12	16.4	54363-0578	54363-0571	50	○
10.5	11.9	9.5	13.9	54363-0478	54363-0471	40	○
8	9.4	7	11.4	54363-0378	54363-0371	30	○
5.5	6.9	4.5	8.9	54363-0278	54363-0271	20	○

D	C	B	A	エンボス梱包品 EMBOSSED TAPE PACKAGING	製品番号 MATERIAL NO.	極数 CIRCUITS	量産対応 AVAILABLE	
GENERAL TOLERANCES: (UNLESS SPECIFIED) — 一般公差				SCALE 10-1	DESIGN UNITS <input checked="" type="checkbox"/> mm <input type="checkbox"/> INCH	THIRD ANGLE PROJECTION	DIMENSIONS: <input type="checkbox"/> mm <input type="checkbox"/> INCH <input type="checkbox"/> mm <input checked="" type="checkbox"/> mm ONLY	
10 UNDER 未満				DRAWN BY & DATE <i>A. Iida</i> '04/01/06	TITLE: 0.5 mm PITCH B/B CONN. REC. HOUSING ASS'Y (H=2,3mm) WITH FITTING NAIL —LEAD FREE—			
10 OVER 以上	30 UNDER 未満			CHECKED BY & DATE <i>S. Takase</i> '04/01/06	MATERIAL NO. DRAWING NO. SHEET NO. SD-54363-038.S01 SEE CHART SD-54363-038 1 OF 2			
30 OVER 以上				APPROVED BY & DATE <i>S. Takase</i> '04/01/06	MOLEX INCORPORATED			
WIRE RANGE 適用電線範囲				CAD FILENAME SD-54363-038.S01				SIZE B
FINISH 仕上げ				THIS DRAWING CONTAINS INFORMATION THAT IS PROPRIETARY TO MOLEX INCORPORATED AND SHOULD NOT BE USED WITHOUT WRITTEN PERMISSION.				REVISE ON CAD ONLY
MATERIAL 材料				EN-02J(097) MXJ-54				

DO NOT SCALE DRAWING

DWG. NO. SD-54363-038

8 7 6 5 4 3 2 1

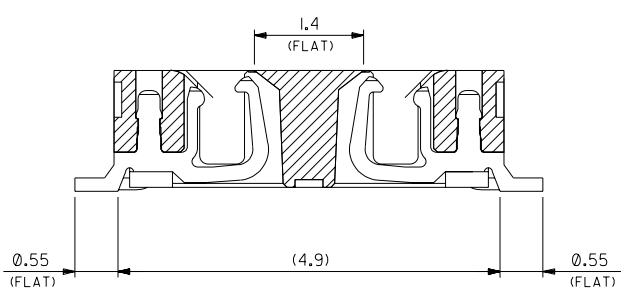

製品断面図 (半田付け部、吸着面寸法)
DETAIL FOR SOLDERING AND VACUUM AREA

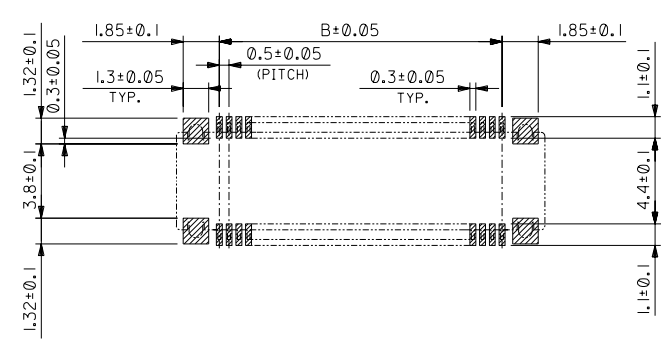

推奨基板寸法
RECOMMENDED PCB PATTERN LAYOUT
(SCALE:5-1)

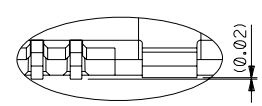

寸法詳細
DETAIL T

DO NOT SCALE DRAWING	EC NO.	EC NO.	EC NO.	EC NO.	SEE SHEET 1 OF 2	MATERIAL	GENERAL TOLERANCES:	SCALE	DESIGN UNITS	THIRD ANGLE PROJECTION	DIMENSIONS:	SHT	REV
	DRWN:	DRWN:	DRWN:	DRWN:	EC NO.	FINISH	(UNLESS SPECIFIED)	20-1	<input checked="" type="checkbox"/> mm <input type="checkbox"/> INCH	<input type="checkbox"/> mm <input type="checkbox"/> INCH <input checked="" type="checkbox"/> mm ONLY	mm	REVISE ON	
	CHK:	CHK:	CHK:	CHK:	DRWN:	仕上付	10 UNDER	DRAWN BY & DATE	<input type="checkbox"/> mm <input type="checkbox"/> INCH	<input type="checkbox"/> mm ONLY	INCH	CAD ONLY	
	APPR:	APPR:	APPR:	APPR:	CHK:	注記参照 SEE NOTES	10 OVER	A. Iida '04/01/06	TITLE:	0.5 mm PITCH B/B CONN. REC. HOUSING ASS'Y	mm		
				APPR:	DESCRIPTION	30 UNDER	+0.2	CHECKED BY & DATE	Q. Takaya '04/01/06	(H=2,3mm) WITH FITTING NAIL			
					WIRE RANGE	30 OVER	+0.25	APPROVED BY & DATE	Y. Yamada '04/01/06	(H=2,3mm) WITH FITTING NAIL			
					適用電線範囲	以上	+0.3	CAD FILENAME	SD-54363-038.S02	-LEAD FREE-			
					INS. RANGE			MATERIAL NO.	SEE CHART				
					被覆外径			DRAWING NO.	SD-54363-038				
					REV			SHEET NO.	2				
								SIZE	B				
								THIS DRAWING CONTAINS INFORMATION THAT IS PROPRIETARY TO MOLEX INCORPORATED AND SHOULD NOT BE USED WITHOUT WRITTEN PERMISSION.					
													EN-02J(097) MXJ-54

DWG. NO. SD-54363-039

8 7 6 5 4 3 2 1

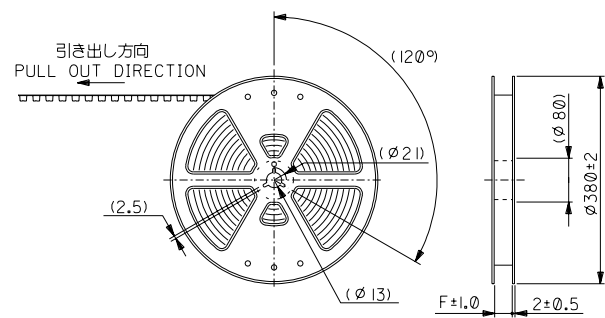

注) NOTES

- 製品番号 54363-***71 詳細寸法については、製品単体図面を参照下さい。
IN THE PACKAGE PART NUMBER 54363-***71 DETAILED DIMENSIONS, SEE SALES DRAWING FOR CONNECTOR.
- 梱包数量: 2500個/リール
NUMBER OF CONNECTORS: 2500 PCS/REEL.
- リードテープ長さ
LEAD TAPE LENGTH

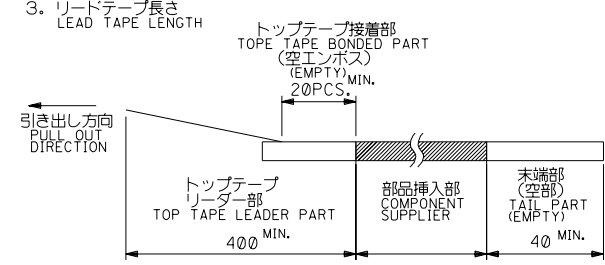

- トップテープの剥離強度: (剥離方向は下図参照)
PEELING OFF FORCE OF TOP TAPE (PELLING DIRECTION AS SHOWN IN FOLLOWING FIGURE.)
0.1~1.3N (10~130gf)

尚、本規格値は、出荷時に適用。
THIS REQUIREMENT SHOULD BE APPLIED AT SHIPMENT.
(但し、輸送時に剥離が発生しない事。)
(PEEL OFF SHOULD NOT BE ALLOWED, DURING TRANSPORTATION.)

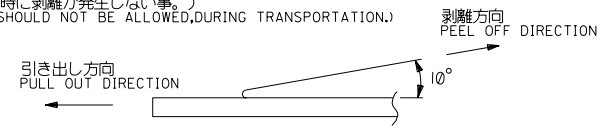

- 材料
MATERIAL
キャリアテープ: ポリプロピレン (PP)
CARRIER TAPE: POLYPROPYLENE (PP)
トップテープ: PET, PE, PEF
TOP TAPE: PET, PE, PEF
リール: ポリスチレン
REEL: POLYSTYRENE
- この製品は54363-***01, (エンボス梱包品 54363-***08)の鉛フリー品です。
THIS PRODUCT IS 'LEAD FREE' OF 54363-***01, (EMBOSSED TAPE PKG 54363-***08)

DO NOT SCALE DRAWING

EC NO. DRWN: CH'K: APPR:			EC NO. DRWN: CH'K: APPR:			EC NO. DRWN: CH'K: APPR:			REVISED ECNNO. J2004-2225 DRWN: A.IDA '04/02/02 CH'K: H.TAKASE APPR: MIYAZAWA, YO.ITO			RELEASED ECNNO. J2004-1740 DRWN: A.IDA '04/01/06 CH'K: H.TAKASE APPR: MIYAZAWA, YO.ITO			MATERIAL 材料 注記参照 SEE NOTES			GENERAL TOLERANCES: (UNLESS SPECIFIED) — 一般公差			SCALE NONE			DESIGN UNITS <input checked="" type="checkbox"/> mm <input type="checkbox"/> INCH			THIRD ANGLE PROJECTION			DIMENSIONS: <input type="checkbox"/> mm <input type="checkbox"/> INCH <input checked="" type="checkbox"/> mm ONLY			SHT REV		
FINISH 仕上げ 注記参照 SEE NOTES			WIRE RANGE 適用電線範囲			INS. RANGE 被覆外径			10 UNDER 未満 +0.2			10 OVER 以上 30 UNDER 未満 +0.25			30 OVER 以上 +0.3			DRAWN BY & DATE A. Iida '04/01/06			CHECKED BY & DATE S. Takase '04/01/06			APPROVED BY & DATE Y. Ito '04/01/06			TITLE: 54363-***71 TAPING PACKAGE -LEAD FREE-			REVISE ON CAD ONLY					
CAD FILENAME SD-54363-039.S01			MATERIAL NO. SEE CHART			DRAWING NO. SD-54363-039			ANGLE 角度 ±3°			THIS DRAWING CONTAINS INFORMATION THAT IS PROPRIETARY TO MOLEX INCORPORATED AND SHOULD NOT BE USED WITHOUT WRITTEN PERMISSION.			MOLEX INCORPORATED			SHEET NO. 1 OF 2			SIZE B														

8 7 6 5 4 3 2 1 EN-02J(097) MXJ-54

DWG. NO. SD-54363-039

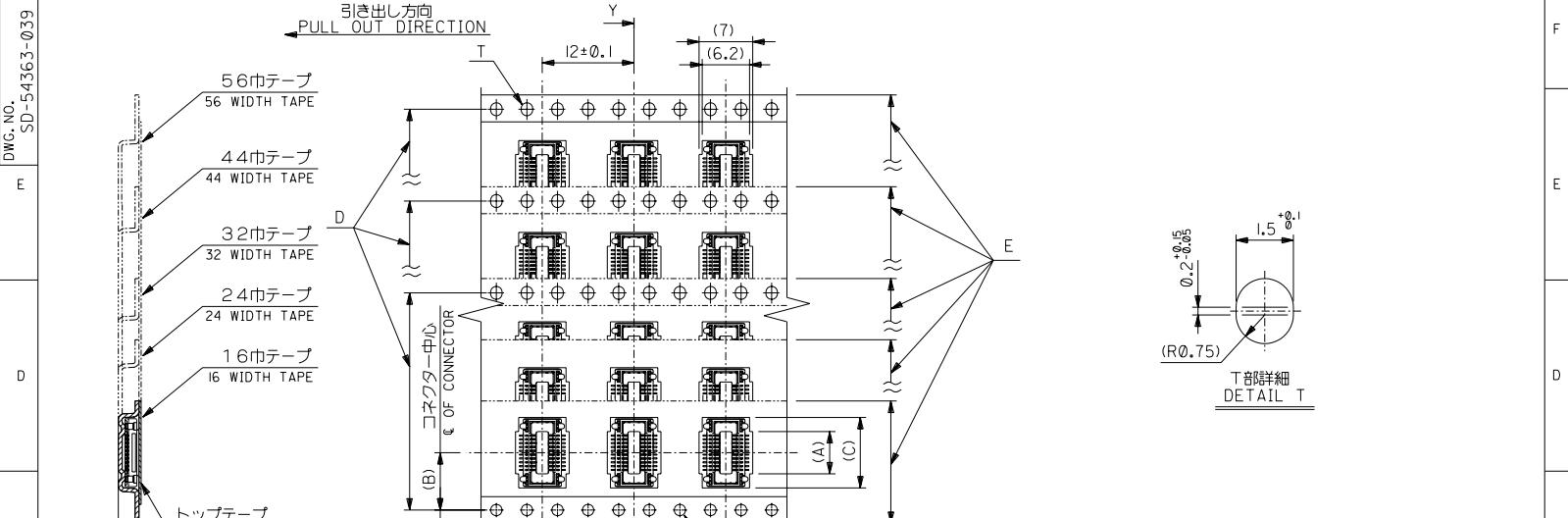

57.5	56±0.3	52.4	44.2 39.2 34.2	26.2	40.55 35.55 30.55	54363-1678 54363-1478 54363-1278	160 140 120	— ○ ○
45.5	44±0.3	40.4	31.7 29.2 26.7 24.2	20.2	28.05 25.55 23.05 20.55	54363-1178 54363-1078 54363-0978 54363-0878	110 100 90 80	○ ○ — ○
33.5	32±0.3	28.4	21.7 19.2	14.2	18.05 15.55	54363-0778 54363-0678	70 60	○ ○
25.5	24±0.3	—	16.7 14.2 11.7	11.5	13.05 10.55 8.05	54363-0578 54363-0478 54363-0378	50 40 30	○ ○ ○
17.5	16±0.3	—	9.2	7.5	5.55	54363-0278	20	○

DO NOT SCALE DRAWING		SEE SHEET 1 OF 2		MATERIAL FINISH		GENERAL TOLERANCES: UNLESS SPECIFIED		SCALE: NONE		DESIGN UNITS: mm		THIRD ANGLE PROJECTION		DIMENSIONS: mm		SHT: 2		REV: 1	
EC NO.	DRWN:	CHK:	APPR:	EC NO.	DRWN:	CHK:	APPR:	10 UNDER	+0.2	DRAWN BY & DATE	TITLE: 54363-***71 TAPING PACKAGE -LEAD FREE-		MATERIAL NO. 54363-039.S02		DRAWING NO. SD-54363-039		SHEET NO. 2		
EC NO.	DRWN:	CHK:	APPR:	EC NO.	DRWN:	CHK:	APPR:	10 OVER	+0.25	CHECKED BY & DATE	MATERIAL NO. SEE CHART		DRAWING NO. SD-54363-039		SHEET NO. B		SIZE		
EC NO.	DRWN:	CHK:	APPR:	EC NO.	DRWN:	CHK:	APPR:	30 OVER	+0.3	APPROVED BY & DATE	MATERIAL NO. SEE CHART		DRAWING NO. SD-54363-039		SHEET NO. B		SIZE		
WIRE RANGE		INS. RANGE		ANGLE		CAD FILENAME		ANGLE		MATERIAL NO.		DRAWING NO.		SHEET NO.		SIZE		EN-02J(097) MXJ-54	

8	7	6	5	4	3	2	1
---	---	---	---	---	---	---	---