

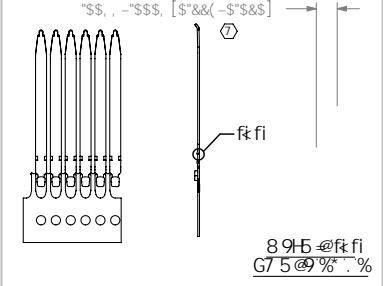

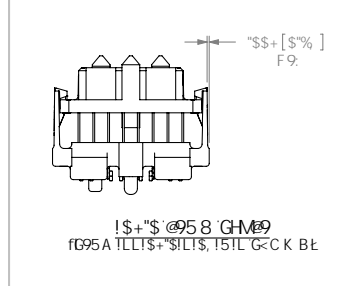

F9J GCB '57

IS\*) H-FI 1% S @ 95 B GM 9G  
 FGSA 95G: ± " 9L 7 9DH5GG<CK B<  
 FG95A I' S!S- "SILL'S, ILLIL G<CK B<  
 FCCA 97 9BHF: 95H F9GBC HG<CK B: CF 7 @ 5F+M<

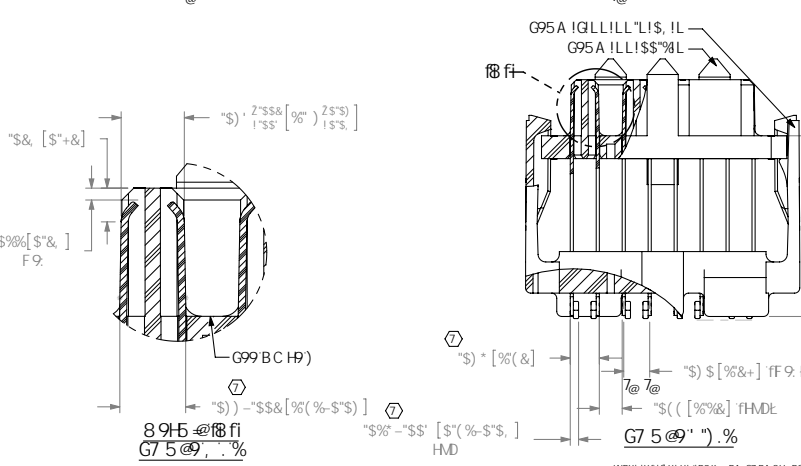
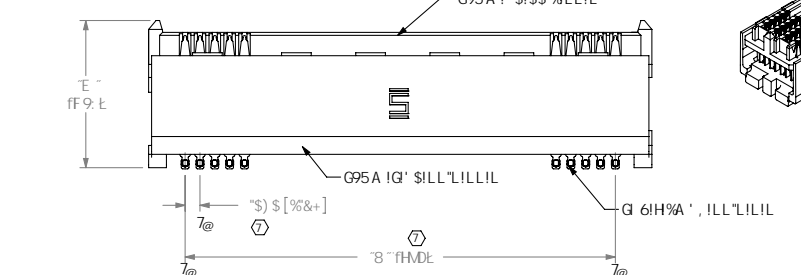
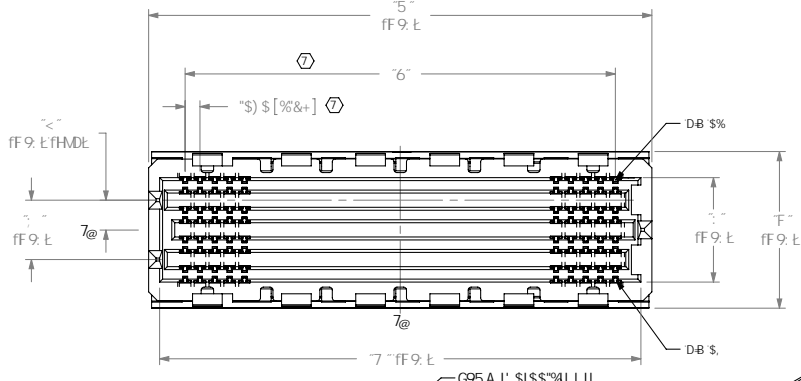

**TABLE 9**  
STACK HEIGHT

SEAM-S LEAD STYLE	SEAF LEAD STYLE		
	-05.0	**06.0	-06.5
**06.5	11.5mm	12.5mm	13mm
-07.0	12mm	13mm	13.5mm
-09.0	14mm	15mm	15.5mm
-11.0	16mm	17mm	17.5mm
*-13.0	18mm	19mm	19.5mm

I 1 BC H C @ 98  
 H 1 BC HF 9 @ 95 G 98 : C F DFC 81 7 HC B

**TABLE 10**

ROW	STYLE	"P"	"Q"	"R"	SPACER BODY	TOP BODY	TERMINAL
-04	-07.0	.271 [6.88]	.417 [10.60]	.328 [8.33]	SEAM-S-XX-07 0-04-X	SEAM-XX-00 1-04	SUB-T-1M38-07 0-X-X
	-09.0	.350 [8.89]	.496 [12.60]	.328 [8.33]	SEAM-S-XX-09 0-04-X	SEAM-XX-00 1-04	SUB-T-1M38-09 0-X-X
	-11.0	.429 [10.90]	.575 [14.60]	.328 [8.33]	SEAM-S-XX-11 0-04-X	SEAM-XX-00 1-04	SUB-T-1M38-11 0-X-X
-05	-07.0	.271 [6.88]	.417 [10.60]	.428 [10.87]	SEAM-S-XX-07 0-06-X	SEAM-XX-00 1-05	SUB-T-1M38-07 0-X-X
	-09.0	.350 [8.89]	.496 [12.60]	.428 [10.87]	SEAM-S-XX-09 0-06-X	SEAM-XX-00 1-05	SUB-T-1M38-09 0-X-X
	-11.0	.429 [10.90]	.575 [14.60]	.428 [10.87]	SEAM-S-XX-11 0-06-X	SEAM-XX-00 1-05	SUB-T-1M38-11 0-X-X
-06	-07.0	.271 [6.88]	.417 [10.60]	.428 [10.87]	SEAM-S-XX-07 0-08-X	SEAM-XX-00 1-06	SUB-T-1M38-07 0-X-X
	-09.0	.350 [8.89]	.496 [12.60]	.428 [10.87]	SEAM-S-XX-09 0-08-X	SEAM-XX-00 1-06	SUB-T-1M38-09 0-X-X
	-11.0	.429 [10.90]	.575 [14.60]	.428 [10.87]	SEAM-S-XX-11 0-08-X	SEAM-XX-00 1-06	SUB-T-1M38-11 0-X-X
-08	**06.5	.252 [6.40]	.400 [10.16]	.528 [13.41]	SEAM-S-XX-06 5-08-X	SEAM-XX-00 1-08	SUB-T-1M38-06 5-X-X
	-07.0	.271 [6.88]	.417 [10.60]	.528 [13.41]	SEAM-S-XX-07 0-08-X	SEAM-XX-00 1-08	SUB-T-1M38-07 0-X-X
	-09.0	.350 [8.89]	.496 [12.60]	.528 [13.41]	SEAM-S-XX-09 0-08-X	SEAM-XX-00 1-08	SUB-T-1M38-09 0-X-X
-10	**06.5	.252 [6.40]	.400 [10.16]	.628 [15.95]	SEAM-S-XX-06 5-10-X	SEAM-XX-00 1-10	SUB-T-1M38-06 5-X-X
	-07.0	.271 [6.88]	.417 [10.60]	.628 [15.95]	SEAM-S-XX-07 0-10-X	SEAM-XX-00 1-10	SUB-T-1M38-07 0-X-X
	-09.0	.350 [8.89]	.496 [12.60]	.628 [15.95]	SEAM-S-XX-09 0-10-X	SEAM-XX-00 1-10	SUB-T-1M38-09 0-X-X
	-11.0	.429 [10.90]	.575 [14.60]	.628 [15.95]	SEAM-S-XX-11 0-10-X	SEAM-XX-00 1-10	SUB-T-1M38-11 0-X-X
	*-13.0	.508 [12.90]	.654 [16.60]	.628 [15.95]	SEAM-S-XX-13 0-10-X	SEAM-XX-00 1-10	SUB-T-1M38-13 0-X-X

I 1 BC H C @ 98  
 H 1 BC HF 9 @ 95 G 98 : C F DFC 81 7 HC B

DFC DF 9 5 F M B C H D  
 H 4 B C 7 1 A 9 B H 7 C B 6 B C B C F A 5 H C B  
 7 C B 4 H 8 H 8 5 B 5 D F C F 4 E F 1 M C  
 G A H 7 2 4 7 " S B G 5 M B C H 6 9 7 9 0 F C 8 1 7 9 8  
 C F H S B G 9 7 9 8 H C C H 9 F B C 7 1 A 9 B H C F  
 8 6 7 4 6 8 H E C H 9 F C F 1 0 8 : C F S B M  
 D F D C 0 9 C H 9 F H S B H S H K 4 7 4 H K 5 G  
 C 0 6 8 9 8 K H C 1 H K 9 L D F 9 2 9 8 K F H 8 B  
 7 C B 0 8 H C : G A H 7 2 4 7 "



) & D5F7 95GH68 82B9K 5065B2B (+) S  
 D<C B 9 984-(1'+ ..... 5L., 982. ( ) S(+  
 YIA UJ. 3z.4 GSA H7 "Wz ..... WcXY.) ) &  
 8 9 C T F D H C B.  
 \$) S D H 7 < H 7 F A B 5 @ 5 F F 5 M 5 G 9 A 6 @ M  
 8 K : " B C "  
**G95A ILLILL " LILLILL LILL**  
 6M 6F5H7 < 9F \$ \* # & \$ \$( G< 99H " C : +

F9J GCB 57

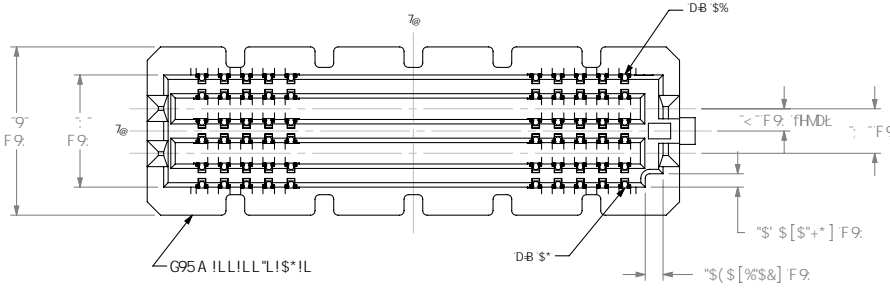

IS\* FCK G  
 fG5A 95G: + "29L7 9DH5GG<C K B<  
 fG95A 1&S!\$&'\$!L'L\$\*L'L5 G<C K B<  
 fGC A 97 9B H F : 95 H F 9 G B C H G<C K B : C F 7 @5 F H M L

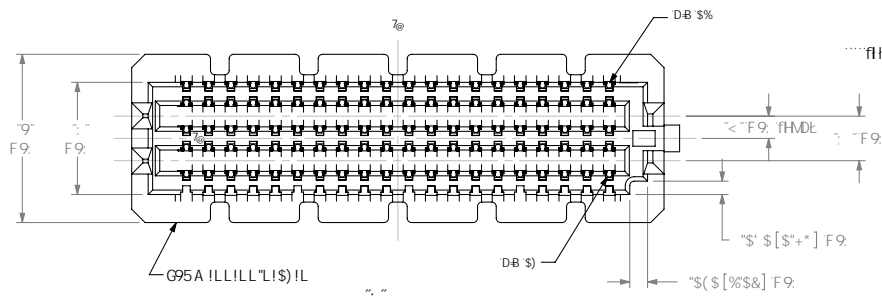

IS\* FCK G  
 fG5A 95G: + "29L7 9DH5GG<C K B<  
 fG95A 1&S!\$&'\$!L'L\$\*L'L5 G<C K B<  
 fG99 BC H7 (L  
 fDC A 97 9B H F : 95 H F 9 G B C H G<C K B : C F 7 @5 F H M L

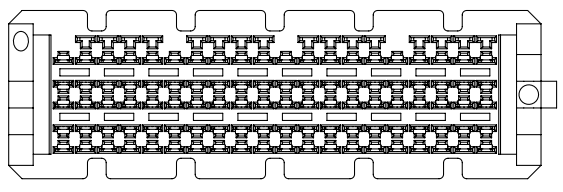
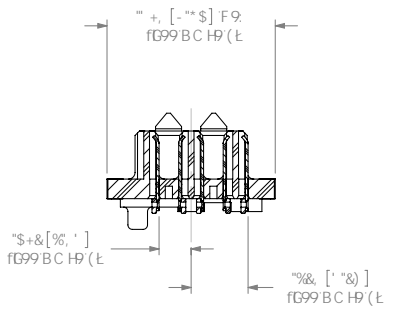
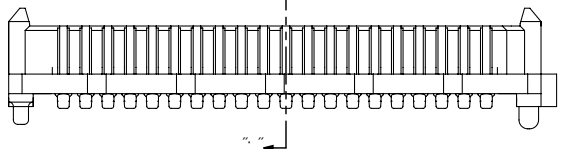

G97 HC B 1

DFC DF 95 FMBC H9  
 H 4 B C 7 1 A 9 B H 7 C B 6 B G B : C F A 5 H C B  
 7 C B : 8 H 8 H 5 B B D F C F 4 E 1 F M C  
 G 5 A 1 H 7 2 4 7 " 5 B B G 5 H B C H 6 9 7 9 0 C B 1 7 9 B  
 C F H 5 B G 9 F 9 B H C C H 9 F B C 7 1 A 9 B H C F  
 8 6 7 4 6 9 H E C H 9 F G C F 1 0 B : C F 5 B M  
 D F D C 0 9 C H 9 F H 5 B H 5 H K 4 F 4 H K 5 G  
 C 4 B 4 9 B K 4 K 1 H K 9 L D F 9 2 9 B K F 4 H B  
 7 C B 0 9 H C : G 5 A 1 H 7 2 4 7 "

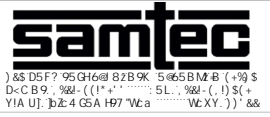

8 9 0 7 F 4 H C B  
 "\$) \$ D+H7 < H9FA B5 @5 FF5 M5 G99A 6 @M  
 8K : " BC "  
**G95A ILLILL'LILL'LILL'LILL**  
 6M 6F 5H7 < 9F \$\* # \$ & \$ \$ ( G< 99H ( " C : +

WPybW fd/fj/ UI 1P8K : PA 67 PA ?H P095A ILLILL'LILL'LILL'LILLIA ?H09B 8FK

F9J GC B '57

H I : D : I - 89 DC GHC DHC B  
 FC B @ M 5 J 5 4 6 6 9 K # : ! \$ & ' @ 9 5 8 G H M 9 Z ( / \* F C K 2 & \$ 2 ' \$ Z ( \$ Z / ) \$ D C G H C B G E  
 fG 5 A 9 5 G : ± ° ′ ″ 9 L 7 9 D H 5 G G < C K B L  
 fG 9 5 A ! & \$ \$ & ' S I L L ! \$ \* 1 & ! 5 ! : D G < C K B L  
 fG C A 9 7 C B H 5 7 H G B C H G < C K B : C F 7 C 6 F H M L  
 H 1 1 B C H F 9 @ 9 5 G 9 8 : C F D F C 8 I 7 H C B

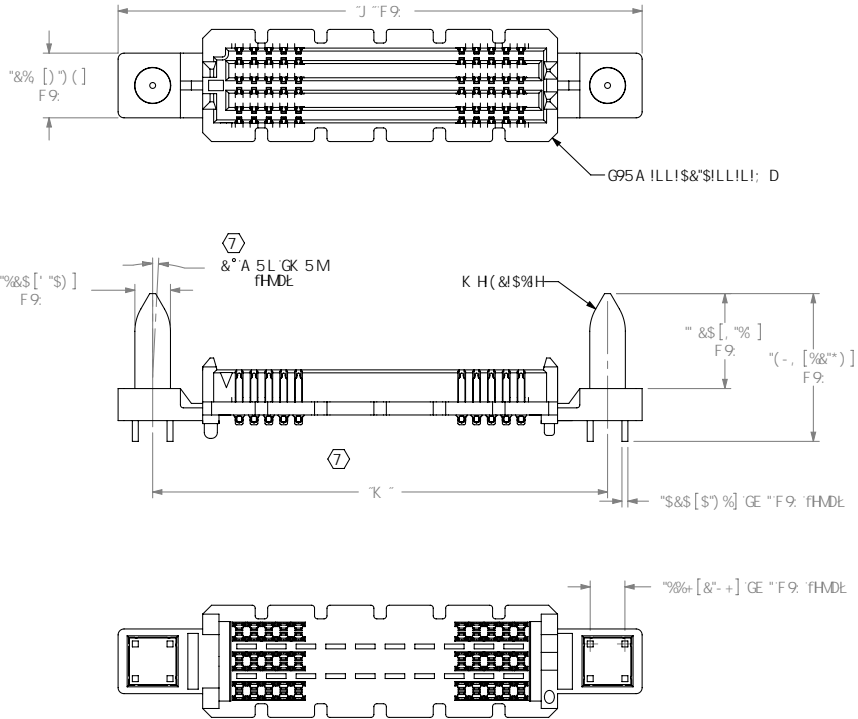

TABLE 14

POSITIONS	"V"	"W"
-20	1.766[44.86]	1.533[38.94]
-30	2.266[57.56]	2.033[51.64]
-40	2.766[70.26]	2.533[64.34]
-50	3.266[82.96]	3.033[77.04]

DFC DF 9 5 F M B C H D  
 H 4 B C 7 1 A 9 8 H 7 C B 1 6 B G B : C F A 5 H C B  
 7 C B : 8 9 H 4 9 5 B B D F C D F 4 E F H M C  
 G 5 A 1 9 7 2 8 7 " S B B G S 5 4 H B C H 6 9 7 9 0 C B 1 7 9 8  
 C F 1 F 5 B G 0 9 F 9 8 H C C H 4 9 F B C 7 1 A 9 8 H C C F  
 8 6 7 4 C 0 6 9 E C H 4 9 C C F 1 0 9 : C F 5 B M  
 D F D C 0 9 C H 9 F H 5 B H 5 H K < F < H K 5 G  
 C 4 6 B 9 8 K 4 K C 1 H K 9 8 D F 9 2 9 8 X F 4 H 8 B  
 7 C B 0 9 H C : G 5 A 1 9 7 2 8 7 "

BC : B C H 0 7 5 4 9 8 F 5 K B :  
 G-99H 0 7 5 4 9 8 & %

8 9 0 7 F D H C B  
 "\$) \$ D H 7 < H 9 F A B 5 @ 5 F F 5 M 5 G 9 A 6 @ M  
 8 K : " BC"  
**G95A !LL!LL "L!LL!LL!LL!**  
 6M 6F5H7 < 9F \$ \* \$ & # \$ \$ ( G < 99H ) ° C : +

) & \$ D 5 F 7 9 5 G H 6 0 B 2 B 9 K 5 6 6 5 B M 2 B (+) \$  
 D < C B 9 9 8 4 - ( 1 + ° ′ ″ : 5 L , ° ′ ″ : ) \$ (+  
 Y I A U J : } : & 4 G 5 A H 7 " W a ° : W e X Y . ) ) & &

F9J GC B 57

: ± " %&  
!%\$. %\$ FCK  
fG95A !' \$!\$&'SILL!%\$!&\$( G<CK BŁ  
DBGCA #H98 %&Z% Z% Z%Z&(Z&) Z& / &-

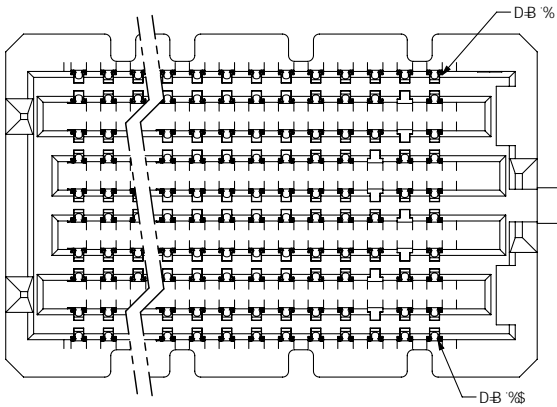

: ± " %\$  
!%\$. %\$ FCK  
fG95A !' \$!\$&'SILL!%\$!&\$( G<CK BŁ  
DBGCA #H98 %&Z% Z% Z%Z&(Z&) Z& Z&-  
' &Z' 'Z' \*Z' +Z((Z)Z(, / (-

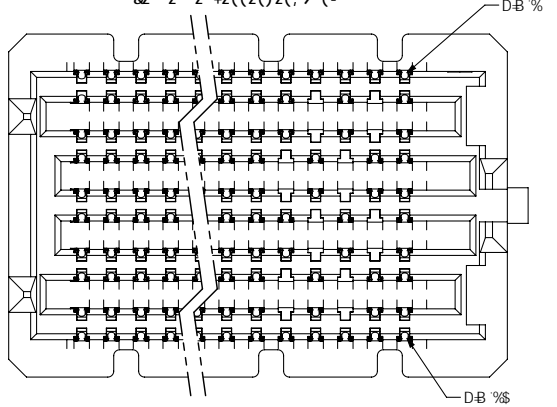

: ± " %&  
!%\$. %\$ FCK  
fG95A !' \$!\$&'SILL!%\$!&\$( G<CK BŁ  
DBGCA #H98 %&Z% Z% Z%Z&(Z&) Z& Z&-  
' &Z' 'Z' \*Z' +Z((Z)Z(, Z(-  
) &Z) 'Z) \*Z) +Z\*(Z\*) Z\*, / \*.-

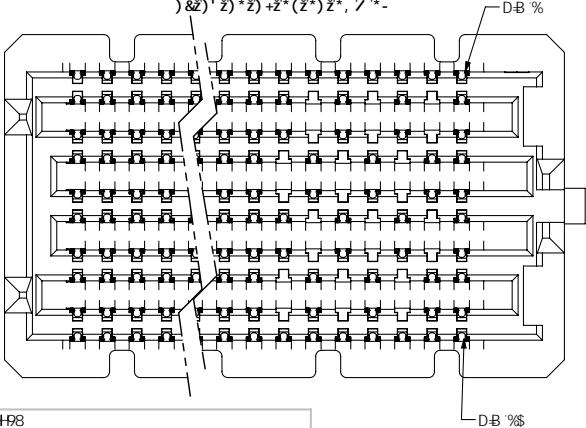

: ± " %&  
!%\$. %\$ FCK  
fG95A !' \$!\$&'SILL!%\$!&\$( G<CK BŁ  
DBGCA #H98 %&Z% Z% Z%Z&(Z&) Z& Z&-  
' &Z' 'Z' \*Z' +Z((Z)Z(, Z(-  
) &Z) 'Z) \*Z) +Z\*(Z\*) Z\*, Z\*-Z  
+&Z' Z+\*Z+Z, (Z,) Z, , / , -

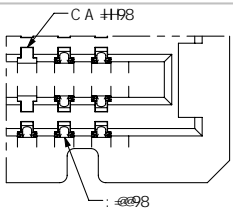
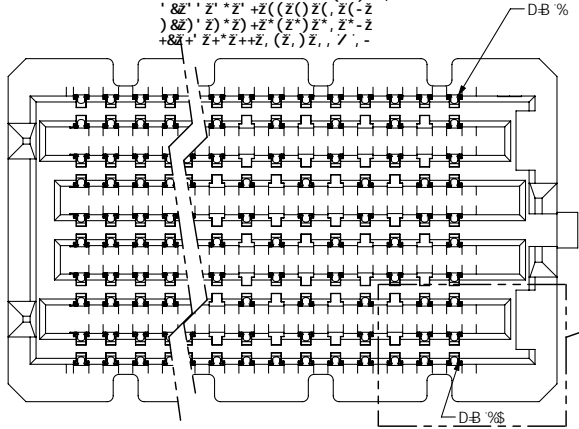

8 9 5 @fi fi  
G 7 5 @) . %

WPybW fd9j UI 1P8K : PA 67 PA 7H P95A ILLILL'LLILLILLILLIA ?H98 BFK

DFC DF 9 5 F M B C H D

K 4 B C 7 1 A 9 B H 7 C B 6 B G B C F A 5 H C B  
7 C B : 8 H 9 H 9 5 B B D F C D F 4 E F 1 M C  
G S A 1 H 7 2 4 7 ' 5 B B G 5 H B C H 6 4 9 7 9 0 C B 1 7 9 8  
C F H 5 B 0 9 F 7 9 8 H C C H 4 9 F B C 7 1 A 9 B H C F  
8 6 7 4 6 9 8 H E C H 4 9 C C F 1 0 9 : C F 5 B M  
D F D C 0 9 C H 4 9 H 5 B H 5 H K 4 7 4 H K 5 G  
C 4 6 B 9 8 K 4 K C 1 H K 9 8 D F 9 2 9 8 K F 4 H 9 8  
7 C B 0 9 H C : G S A 1 H 7 2 4 7

8 C B C H 0 7 5 @ 9 8 F 5 K B :

G-99H 7 5 @ 9 . %



) & D 5 F 7 9 5 G H 6 8 8 2 B 9 K 5 6 6 5 B M 2 B (+) \$  
D<C B 9 : 9 8 4 - (1 \* ' : : : : 5 L . : 9 8 2 . ( ) S (+  
Y I A U J . : 2 4 G S A H 7 ' W 2 a : : : : : W C X Y . ) ) & &

8 9 0 7 F 0 H C B :  
' \$ ) \$ D # 7 < 1 H F A B 5 @ 5 F F 5 M 5 G 3 9 A 6 @ M

8 K : " B C "  
G 9 5 A I L L I L L ' L L I L L I L L I L L I L L

6 M 6 F 5 H 7 < 9 F \$ \* # \$ & \$ \$ ( G < 9 9 H \* C : +

F9J GCB 57

± "%  
 !\$( (FC K  
 FG5A 95G: ± "929L7 9DH5GG<C K B E  
 FG95A 1&S!\$&"SILL!\$(1985 G<C K B E  
 FGCA 97 9B H F : 95H F9GBC HG<C K B : C F 7 @5F #M

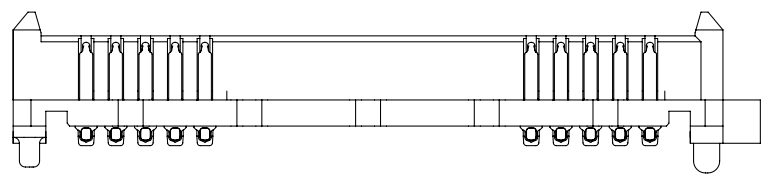
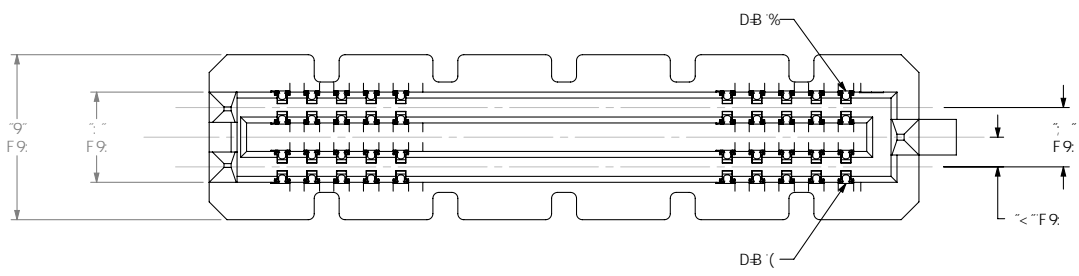

<p><b>DFC DF 95 F M B C H D</b>                  K 4 B C 7 1 A 9 B H 7 C B 6 B G B : C F A 5 H C B                  7 C B : 8 9 B H 9 5 B B D F C D F 4 E F 1 M C                  G S A 1 9 7 2 4 7 " 5 B B G 5 4 9 B C H 6 9 7 9 0 C B 1 7 9 B                  C F H 5 B G 9 F 9 B H C C H 9 F B C 7 1 A 9 B H C F                  8 6 7 4 0 9 H E C H 9 G C F 1 0 9 : C F 5 B M                  D F D C 0 9 C H 9 F H 5 B H 5 H K 4 F 4 H K 5 G                  C 4 6 B 9 8 K 4 K C 1 H K 9 9 D F 9 2 9 8 K F 4 H 8                  7 C B 9 8 H C : G S A 1 9 7 2 4 7 "</p>		<p>) &amp; S D 5 F 7 9 5 G H 6 8 2 B 9 K 5 6 6 5 B M 2 B (+) 9 \$                  D &lt; C B 9 9 8 2 - ( ( 1 + ) ) 5 L . . 9 8 2 - ( ) S ( +                  Y I A U J . 3 2 4 G S A H 7 " W z a . . . . . W e X Y . ) ) &amp; S</p>
<p>8 C : B C H G 7 5 4 9 8 F 5 K B :</p> <p>G 9 9 H G 7 5 4 9 ( %</p>	<p>8 9 0 7 F D H C B :                  "\$) \$ D H 7 &lt; 1 H 9 F A B 5 @ 5 F F 5 M 5 G 9 A 6 @ M                  8 K : " B C "  <b>G 9 5 A ! L L ! L L " L ! L L ! L L ! L L ! L L</b>                  6 M 6 F 5 H 7 &lt; 9 F \$ * # \$ &amp; # \$ \$ ( G &lt; 9 9 H + C : +</p>	

WPYbW fdijj UI 1P8K : PA 67 PA ?H PG95A ILLILL"ILLILLILLIA ?HG9B 8FK