

High-Speed(10+Gbps) BGA Mezzanine Connectors

IT3 Series

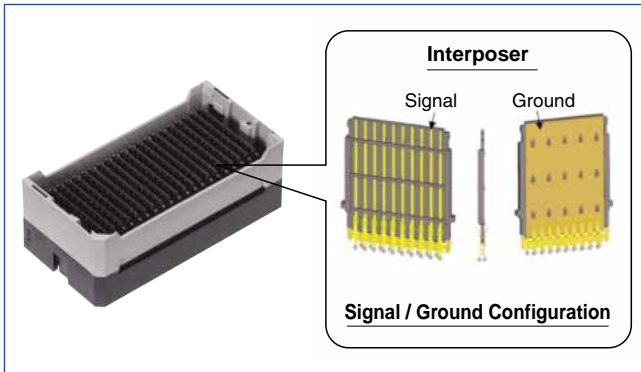
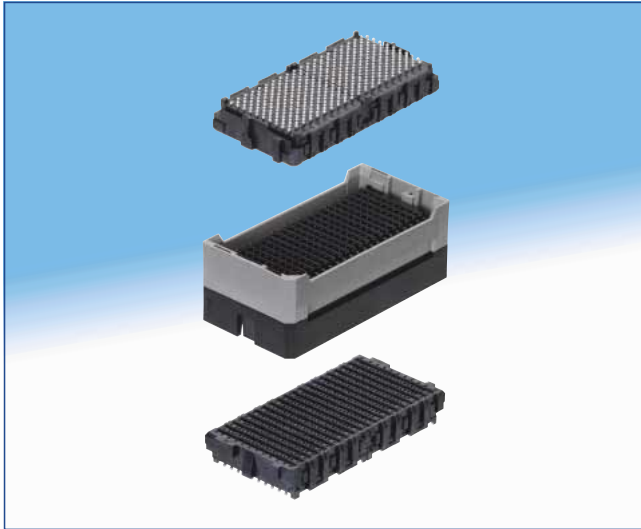

Flexibility

Hirose's IT3 mezzanine connector system is as comfortable in today's data rates of PCIe and XAUI as it is in tomorrow's 10+Gbps systems.

With the ability to transmit differential, single-ended, and power through one package and being stackable from 15 – 40mm, IT3 can solve your interface needs for both current and future generations.

Mechanical features

- Unique 3-piece structure for flexibility
- Stacking heights from 15 to 40mm (*15mmH is 2-piece)
- Staggered 1.5mm × 1.75mm ball grid array
- Number of Contacts: 100, 200, &300 signals + 90% additional grounds
- Differential, single-ended, and power
- Low mating/extracting forces
- Wide misalignment tolerances for multiple connector use
- Both of SnPb and Pb-free are available
- Excellent reflow solderability

Signal integrity features

Insertion loss to Crosstalk Ratio (ICR)

The ICR performance meets the extrapolated IEEE 802.3ap specification for 6.25Gbps with fully-populated pin assignment, and 10+Gbps with skipped pin assignment.

Return Loss

The differential return loss meets the extrapolated IEEE 802.3ap specification up to 12GHz.

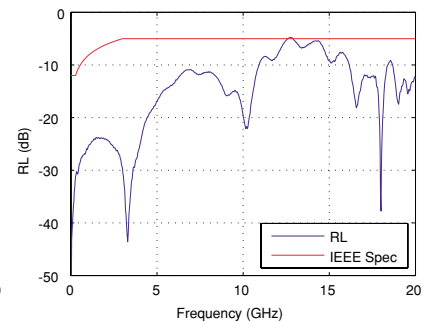
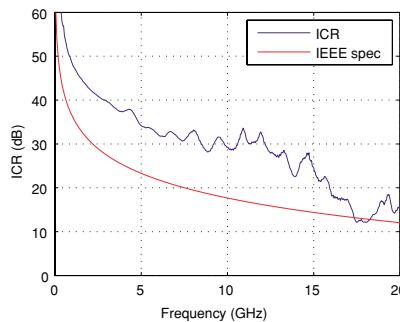

Stacking height variations

Stacking Height / Contact Position	17mm	20mm	22mm	25mm	26mm	28mm	30mm	32mm	38mm	40mm
100	*	✓	*	✓	✓	✓	*	*	✓	✓
200	✓	✓	✓	✓	✓	✓	✓	✓	✓	✓
300	✓	✓	✓	✓	✓	✓	✓	✓	✓	✓

* : Under planning

■Product Specifications

Rating	Current Rating: 1.0A / pin (note 1)	Operating Temperature Range: -55°C to +85°C Operating Humidity Range: For relative humidity, 90% max (no condensation is permitted)
	Voltage Rating: 50Vrms	
	Storage Temperature Range: -10°C to +60°C	

Item	Specification	Conditions
1. Insulation Resistance	1000MΩ min.	100V DC
2. Withstanding Voltage	No flashover or insulation breakdown	150V duty for 60 seconds (2mA max leak)
3. Contact Resistance	50mΩ max. (height 15-24mm) (note 2) 55mΩ max. (height 25-32mm) 60mΩ max. (height 33-40mm)	100mA
4. Vibration	1) No electrical discontinuity of 1μs or more 2) No damage, crack, or loose part	Frequency: 20 to 500Hz; power spectrum density: 0.02G ² /Hz Overall rms G: 3.1 Grms; for 15 minutes in three directions
5. Cyclic Temperature and Humidity	1) Contact resistance change: 20mΩ or less 2) Insulation resistance: 100MΩ min. 3) No damage, crack or loose part	25°C, 80% RH: 60 min dwell time, 30 min ramp time 65°C, 50% RH: 60 min dwell time under 24 cycles
6. Durability (Mating/Un-mating)	1) Contact resistance change: 20mΩ or less 2) No damage, crack or loose part	100 cycles

Note1: Refer to IT3 derating curves on test report TR636E-20041 for power application.

Note2: The value of contact resistance includes 2 contact points and the bulk resistance.

■Material Information

●Receptacle

Component	Material	Finish & Remarks
Housing	LCP	Black , UL 94V-0
Locator	LCP	Black , UL 94V-0
Contact	Copper Alloy	Contact Area : Gold (0.76 μm) over Nickel (1.5 μm) Mounting Area : Gold (0.03 μm) over Nickel (1.5 μm) Other : Nickel (1.5 μm)
Solder Ball	Tin-Lead (SnPb)	Sn(63)-Pb(37)
	Tin (Pb-Free)	Sn(96.5)-Ag(3)-Cu(0.5)
Tray	Polystyrene	Black
Pick Up Cap	Stainless steel	300pos
Pick Up Tape	Paper (Nomex)	100pos and 200pos

●Interposer

Component	Material	Finish & Remarks
Guide (Mounting Side)	PBT	Black , UL 94V-0
Guide (Detachable/Mating Side)	LCP	Gray , UL 94V-0
	PBT	Gray , UL 94V-0
Blade	LCP	Black , UL 94V-0
Contact	Copper Alloy	Contact Area : Gold (0.76 μm) over Nickel (1.5 μm)
Ground Shield	Copper Alloy	Other : Nickel (1.5 μm)
Tray	Polypropylene	—

■ Ordering Information

● Receptacle

$\frac{\text{IT}}{\text{①}} \frac{3}{\text{②}} \frac{**}{\text{②}} - \frac{***}{\text{③}} \frac{\text{S}}{\text{④}} - \frac{\text{BGA}}{\text{⑤}} \frac{**}{\text{⑥}} \frac{(**)}{\text{⑦}}$

● Interposer

$\frac{\text{IT}}{\text{①}} \frac{3}{\text{②}} \frac{**}{\text{②}} - \frac{***}{\text{③}} \frac{\text{P}}{\text{④}} - \frac{**}{\text{⑧}} \frac{\text{H}}{\text{⑥}} \frac{**}{\text{⑥}} \frac{(**)}{\text{⑨}}$

① Series name : IT3	⑤ BGA : Ball Grid Array
② Receptacle Type D : Mating Receptacle D* : Mating Receptacle (Customized) M : Mounting Receptacle M* : Mounting Receptacle (Coustomized) Interposer Type Blank: Standard ** : Customized	⑥ Package Specification Blank : Standard ** : Customized
③ Contact Positions : 100, 180*, 200, 300 *180 pos. is 2 columns depopulated version for higher voltage proof.	⑦ Material and Plating Specification of Receptacle (37) : Pb-free Solder Sn(96.5)-Ag(3.0)-Cu(0.5) Contact Area : Au(0.76μm)+Ni(1.5μm) (57) : Eutectic Solder Sn(63)-Pb(37) Contact Area : Au(0.76μm)+Ni(1.5μm)
④ Connector type S : Receptacle P : Interposer	⑧ Stacking Height (mm) 17, 20, 22, 25, 26, 28, 30, 32, 38, 40 ⑨ Plating Specification of Interposer (03) : Contact Area : Au(0.76μm)+Ni(1.5μm)

Signal Integrity

Pin assignment

For the fully-populated pin assignment, adjacent pins are grouped into differential pairs as shown in the figures below. In the following data, one victim pair and eight aggressor pairs are included.

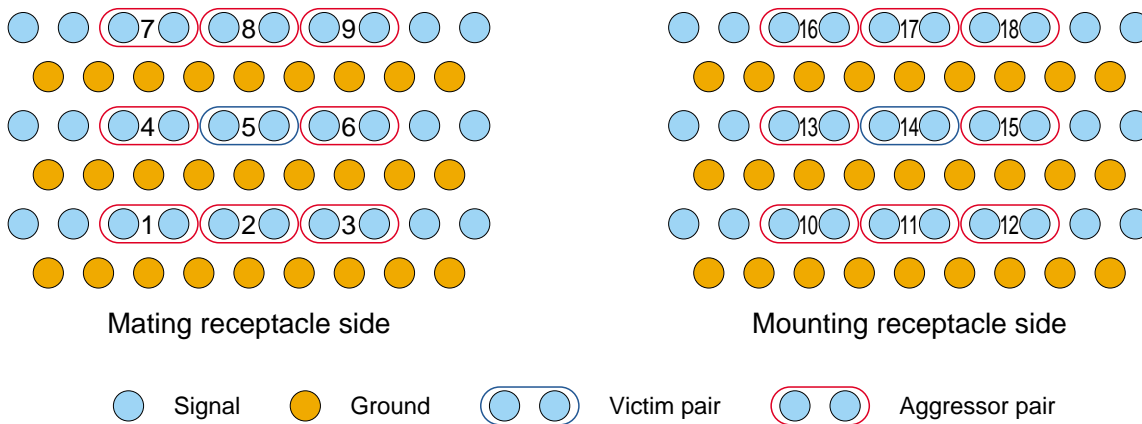

Impedance profile at 60ps rise time (20-80%)

The impedance profiles (of connector only) for the center pair are shown below. The IT3 receptacles are designed with higher impedance to offset the via's low impedance.

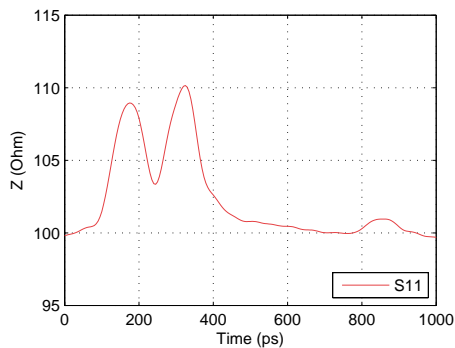

17mm Height

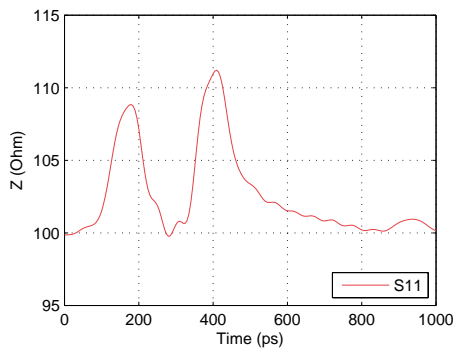

25mm Height

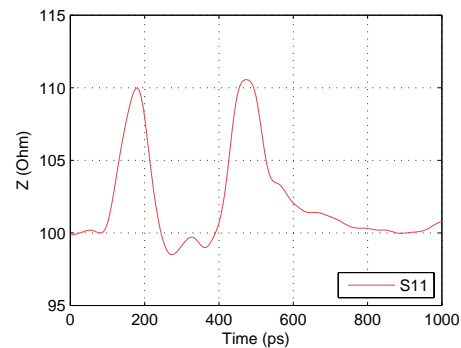

32mm Height

Differential propagation delay

Stacking Height (mm)	17	25	32
Delay (ps)	101.05	146.69	188.48

● **Differential Insertion Loss**

The differential insertion loss is less than -2dB up to 12GHz.

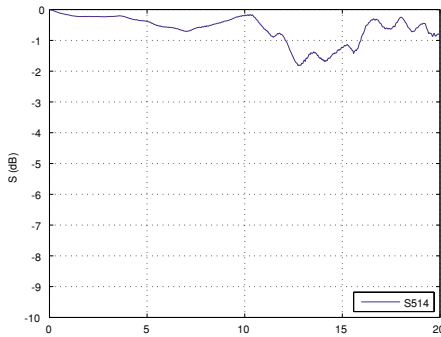

17mm Height

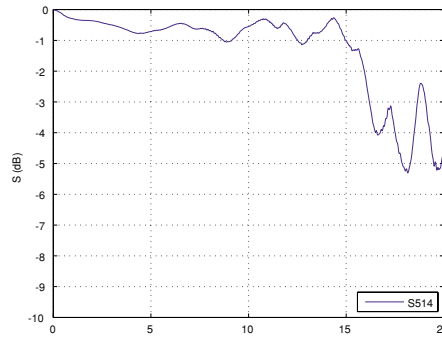

25mm Height

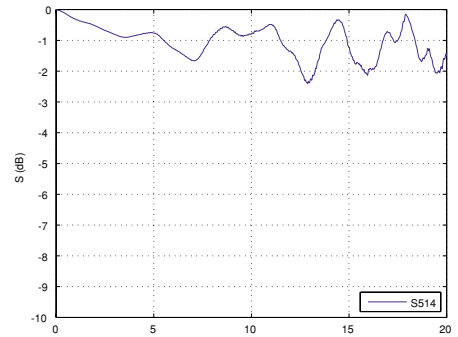

32mm Height

● **Differential Return Loss**

The connector-only differential return loss for the center pair meets the extrapolated IEEE 802.3ap spec up to 12GHz. (The attenuation of PCB traces in the channel will give an even larger margin.)

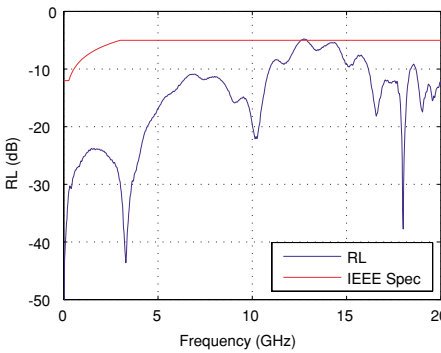

17mm Height

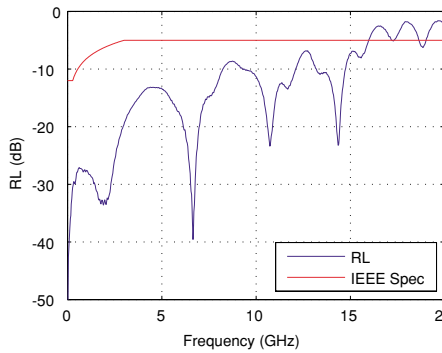

25mm Height

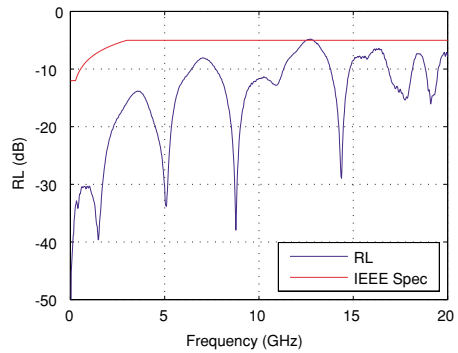

32mm Height

● **Differential Near-End Crosstalk (NEXT)**

The near-end crosstalk at the center pair from surrounding 8 aggressors is shown below. The NEXT is not as critical because TX and RX can be grouped into separate wafers.

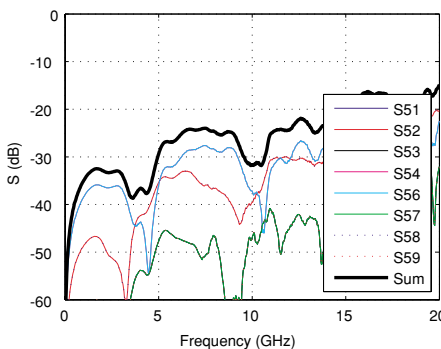

17mm Height

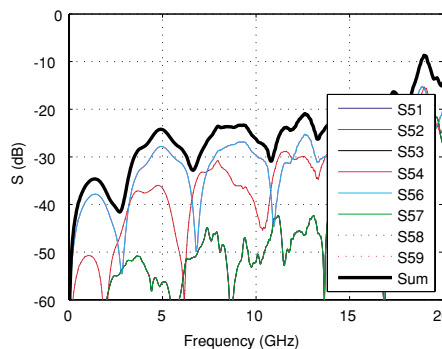

25mm Height

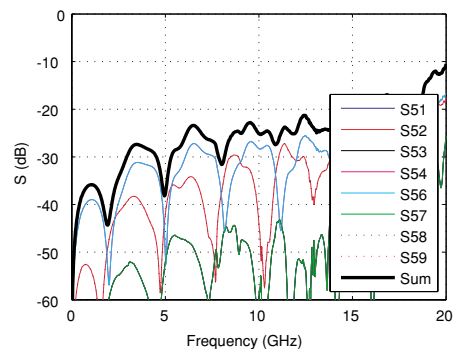

32mm Height

Differential Far-End Crosstalk (FEXT)

Low far-end crosstalk at the center pair from surrounding 8 aggressors is observed. Even lower crosstalk can be achieved by skipping pins.

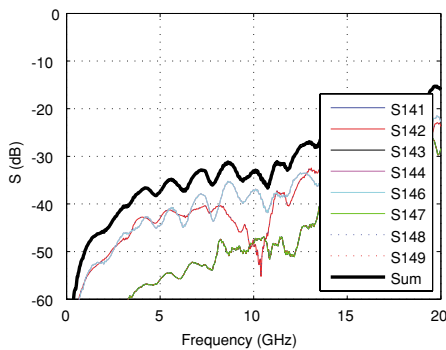

17mm Height

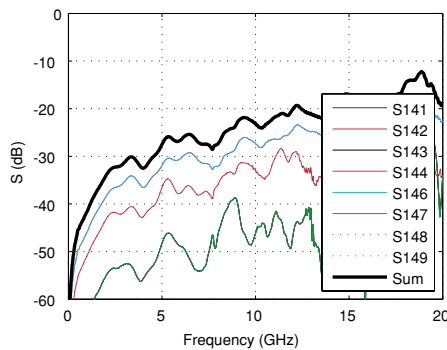

25mm Height

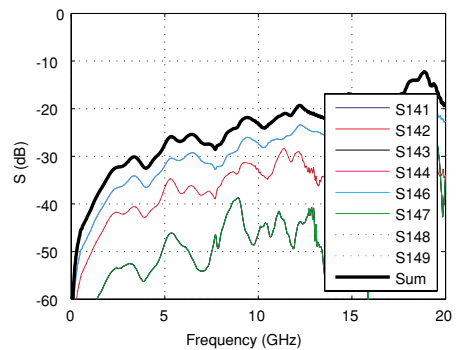

32mm Height

Insertion-Loss-to-Crosstalk-Ratio (ICR) for FEXT

The insertion-loss-to-crosstalk-ratio (ICR) for 8-aggressor FEXT meets the extrapolated IEEE 802.3ap specification up to 12GHz.

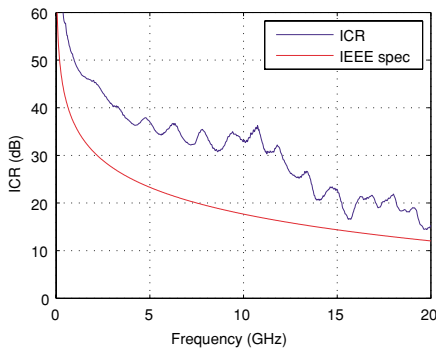

17mm Height

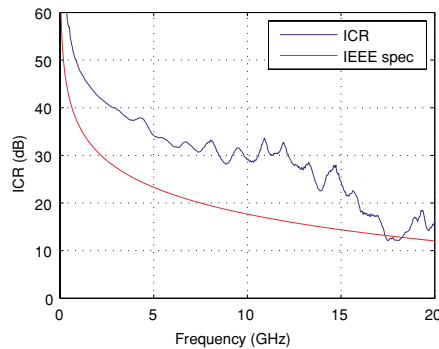

25mm Height

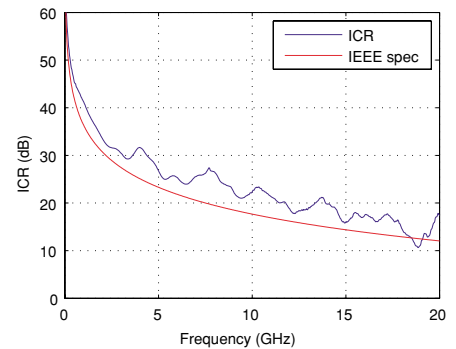

32mm Height

Receptacle

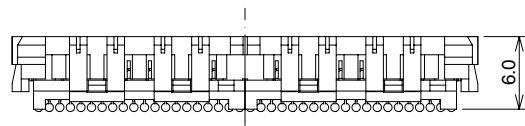
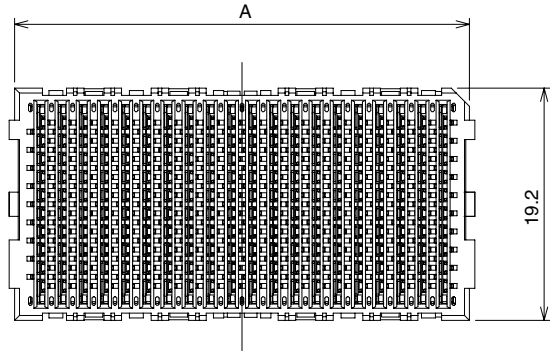
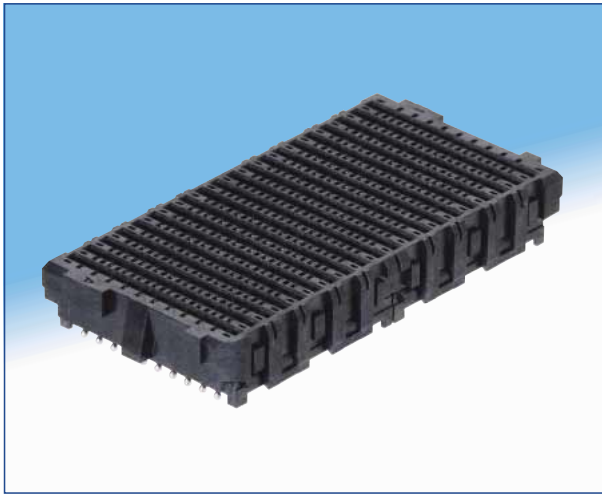

Shown: 200 position mating receptacle, IT3M-200S-BGA

*Unit: mm

Contact Positions	Type	Solder Ball Material	Part Number	CL No.	A
100 (100 signals/90 grounds)	Mating Receptacle	Pb-free (SAC305) solder	IT3D-100S-BGA(37)	636-0013-1-37	21.0
		SnPb solder	IT3D-100S-BGA(57)	636-0013-1-57	
	Mounting Receptacle	Pb-free (SAC305) solder	IT3M-100S-BGA(37)	636-0014-4-37	
		SnPb solder	IT3M-100S-BGA(57)	636-0014-4-57	
180 (180 signals/162 grounds)	Mating Receptacle	Pb-free (SAC305) solder	IT3D2-180S-BGA(37)	636-0011-6-37	38.5
		SnPb solder	IT3D2-180S-BGA(57)	636-0011-6-57	
	Mounting Receptacle	Pb-free (SAC305) solder	IT3M2-180S-BGA(37)	636-0012-9-37	
		SnPb solder	IT3M2-180S-BGA(57)	636-0012-9-57	
200 (200 signals/180 grounds)	Mating Receptacle	Pb-free (SAC305) solder	IT3D-200S-BGA(37)	636-0003-8-37	38.5
		SnPb solder	IT3D-200S-BGA(57)	636-0003-8-57	
	Mounting Receptacle	Pb-free (SAC305) solder	IT3M-200S-BGA(37)	636-0004-0-37	
		SnPb solder	IT3M-200S-BGA(57)	636-0004-0-57	
300 (300 signals/270 grounds)	Mating Receptacle	Pb-free (SAC305) solder	IT3D-300S-BGA(37)	636-0007-9-37	56.0
		SnPb solder	IT3D-300S-BGA(57)	636-0007-9-57	
	Mounting Receptacle	Pb-free (SAC305) solder	IT3M-200S-BGA(37)	636-0008-1-37	
		SnPb solder	IT3M-200S-BGA(57)	636-0008-1-57	

Interposer

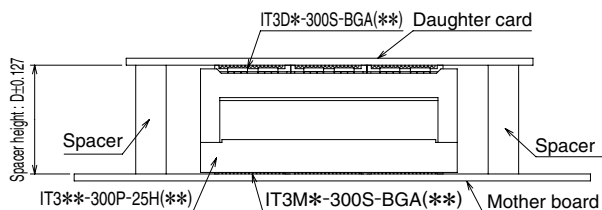
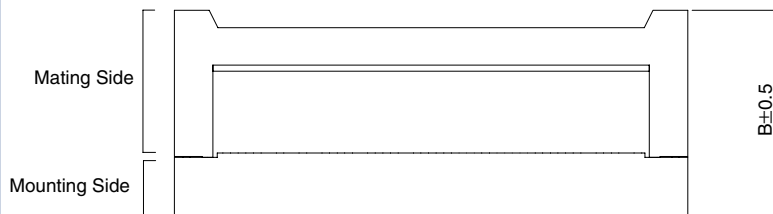
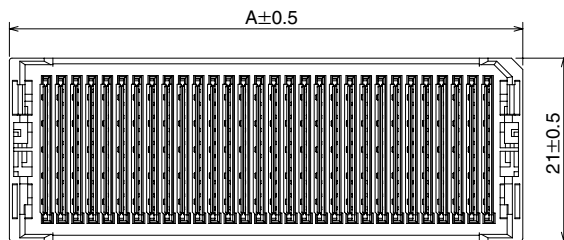

Mating condition with spacers

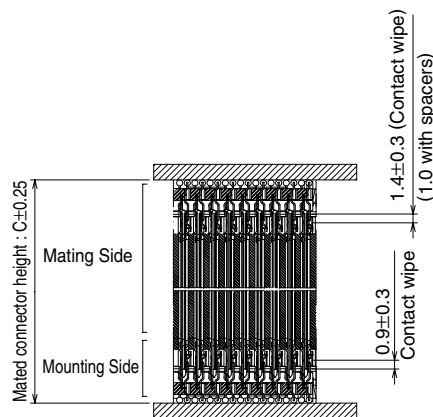

Mating Cross Section(FREE)
Mating condition without spacers

*Unit: mm

Height (mm)	Part Number	CL No.	A	B	C	D	Height (mm)	Part Number	CL No.	A	B	C	D
17	IT3-200P-17H(03)	636-0100-4-03	41.5	15.8	16.6	17.0	28	IT3-100P-28H(03)	636-0170-0-03	24.0	26.8	27.6	28.0
	IT3-300P-17H(03)	636-0130-5-03	59.0					IT3M2-180P-28H(03)	636-0107-3-03	41.5			
20	IT3-100P-20H(03)	636-0223-4-03	24.0	18.8	19.6	20.0		IT3-200P-28H(03)	636-0105-8-03	41.5			
	IT3-200P-20H(03)	636-0224-7-03	41.5					IT3-300P-28H(03)	636-0140-9-03	59.0			
	IT3-300P-20H(03)	636-0225-0-03	59.0					30	IT3-200P-30H(03)	636-0180-3-03			
22	IT3-200P-22H(03)	636-0209-3-03	41.5	20.8	21.6	22.0		IT3-300P-30H(03)	636-0185-7-03	59.0			
	IT3-300P-22H(03)	636-0210-2-03	59.0				32	IT3-200P-32H(03)	636-0115-1-03	41.5	30.8	31.6	32.0
25	IT3-100P-25H(03)	636-0150-2-03	24.0	23.8	24.6	25.0	IT3-300P-32H(03)	636-0145-2-03	59.0				
	IT3M2-180P-25H(03)	636-0157-1-03	41.5				38	IT3-100P-38H(03)	636-0200-9-03	24.0	36.8	37.6	38.0
	IT3-200P-25H(03)	636-0155-6-03	41.5				IT3-200P-38H(03)	636-0195-0-03	41.5				
	IT3-300P-25H(03)	636-0160-6-03	59.0				IT3-300P-38H(03)	636-0190-7-03	59.0				
26	IT3-100P-26H(03)	636-0165-0-03	24.0	24.8	25.6	26.0	40	IT3-100P-40H(03)	636-0230-0-03	24.0	38.8	39.6	40.0
	IT3-200P-26H(03)	636-0110-8-03	41.5				IT3-200P-40H(03)	636-0227-5-03	41.5				
	IT3-300P-26H(03)	636-0135-9-03	59.0				IT3-300P-40H(03)	636-0175-3-03	59.0				

PCB footprint (mounting foot pattern)

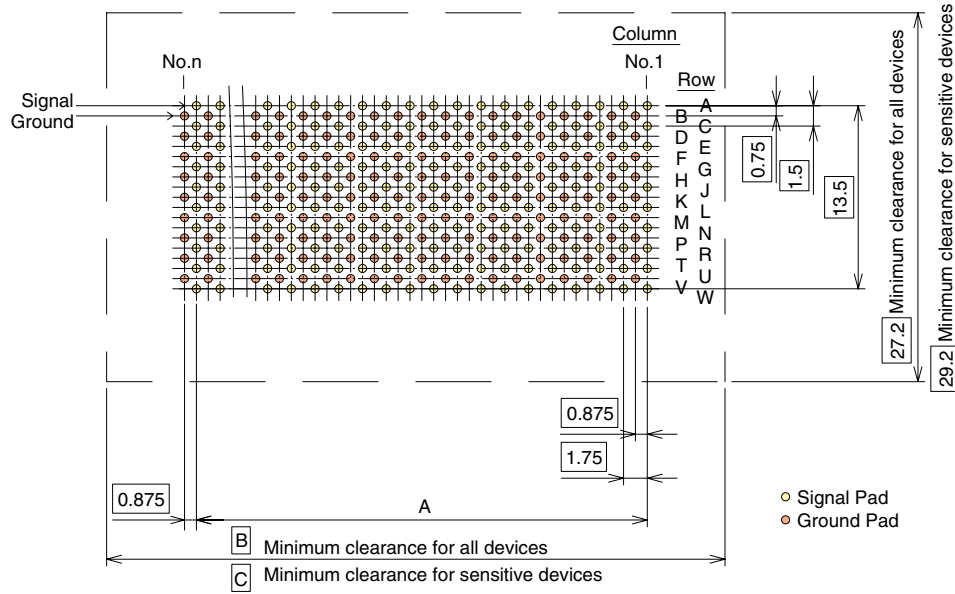

Mounting Receptacle – IT3M

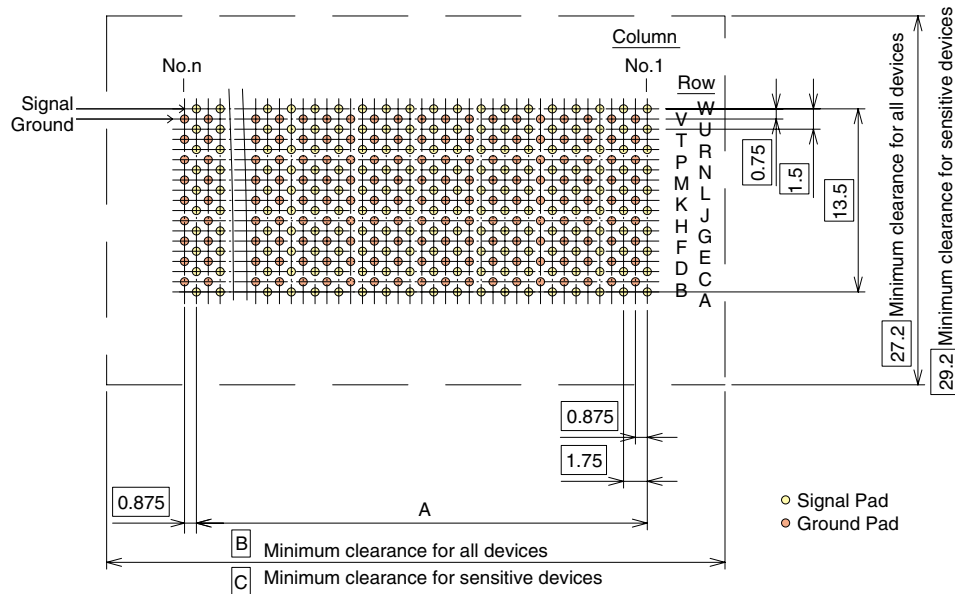

Mating Receptacle – IT3D

*Unit: mm

Dimension (mm)	100	180 / 200	300
A	15.75	33.25	50.75
B	28.10	45.60	63.10
C	30.10	47.50	65.10

Spacers

Spacers are required to support the PWB's and protect the BGA solder joints.

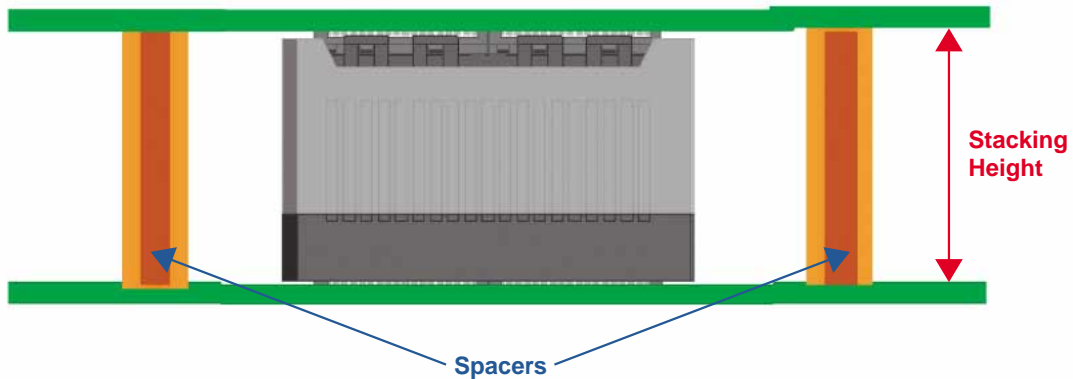

Suggested spacer style is shown below:



Spacer, male-male, M3 thread

The recommended spacer height corresponds to the interposer stacking height as shown in the chart below:

Stacking Height	Recommended Spacer Height
17 mm	17 +/-0.127 mm
20 mm	20 +/-0.127 mm
22 mm	22 +/-0.127 mm
25 mm	25 +/-0.127 mm
26 mm	26 +/-0.127 mm
28 mm	28 +/-0.127 mm
30 mm	30 +/-0.127 mm
32 mm	32 +/-0.127 mm
38 mm	38 +/-0.127 mm
40 mm	40 +/-0.127 mm

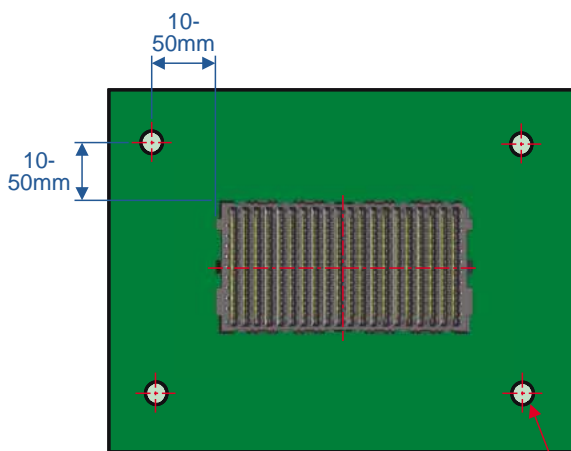

Recommended Spacer Location

$\phi 3.5$
Non plated through hole

Two spacers located diagonally are minimally required. Some applications may require 4 spacers. Spacers should be located 10 – 50 mm from the corners of the receptacles to prevent excessive mechanical loading on the interconnections. If assembly will be subjected to vibration, spacers should be located to prevent resonance, and additional spacers may be required.

Interposer installation

Position interposer directly over mounting receptacle, aligning the polarity chamfers.

If positioned properly, the interposer should slide easily onto the mounting receptacle. Place installation cap onto interposer and push straight down to engage the locking latches:

Manual Installation

*Installation caps are available upon request for manual operation

Press firmly on installation cap only, not on wafers or interposer body

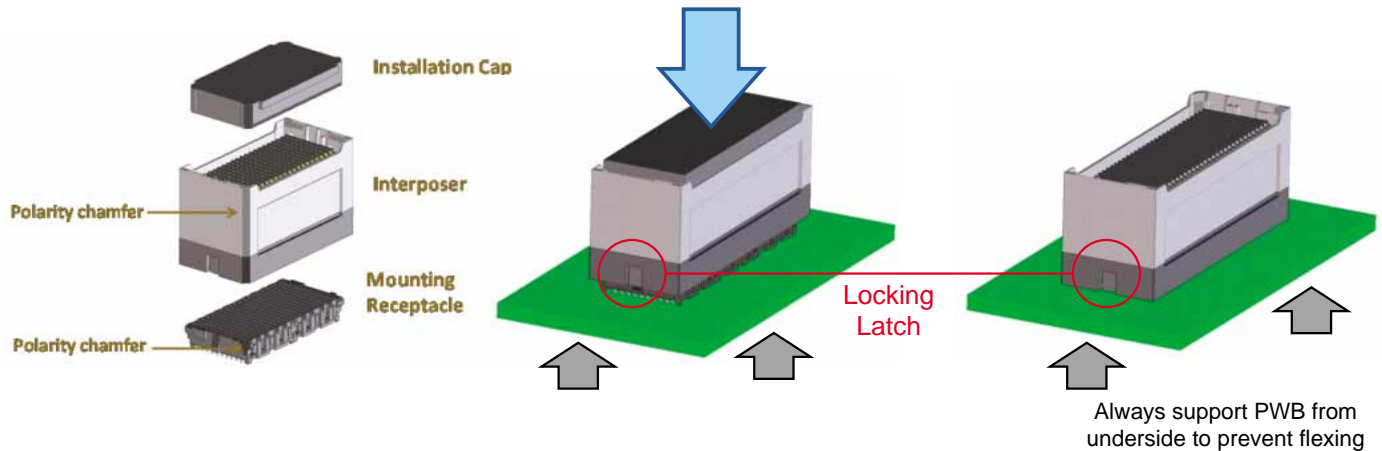

Daughter card installation

After the interposer is mounted, install spacers onto motherboard. To install mating receptacle, align the spacer holes in the daughter card with the threads on the spacers.

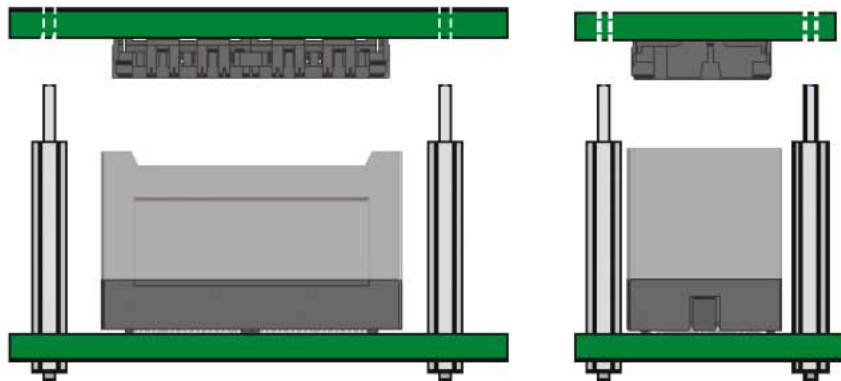

The spacers help align the mating receptacle with the interposer. If positioned correctly, the mating receptacle will slip down into the interposer.

Push directly down on the assembly to lock the mating receptacle in place. Install nuts onto the spacer threads. Tighten nuts to specified torque.

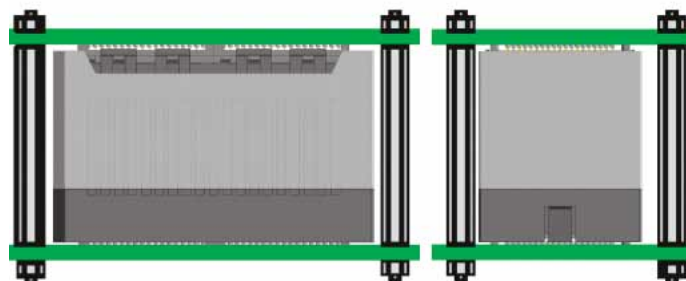

■ Daughter card removal

To remove a daughter card, first remove the nuts from the reinforcing spacers, then lift the daughter card straight off the interposers, as shown right.

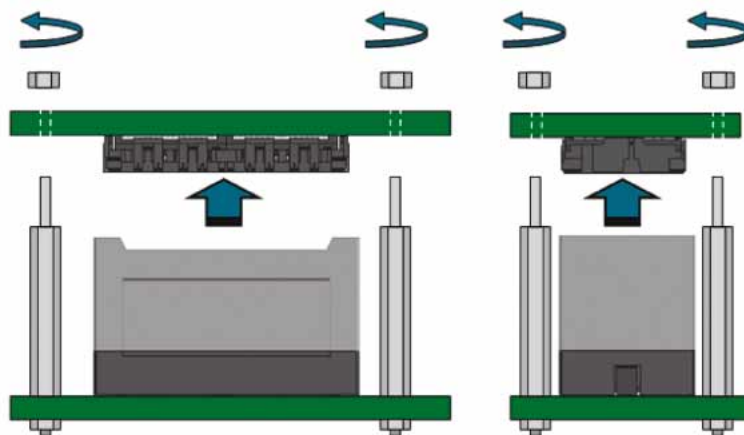

■ Interposer removal

Interposer Removal

- 1) Hold the Interposer Assembly on the walls without locking latches

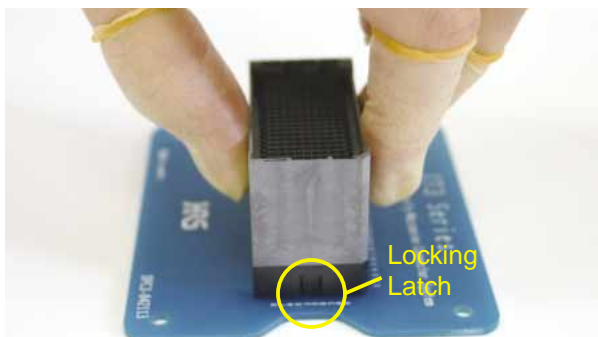

- 2) Gently rotate one side of the Interposer Assembly laterally 10° maximum



Caution: do not rotate more than 10 degrees

- 3) While gently rotating, pull up on other side of the Interposer Assembly

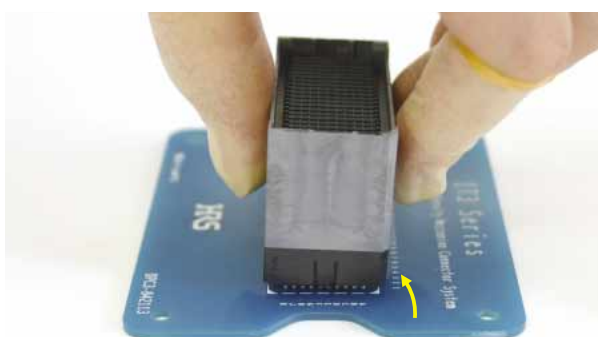

- 4) The Interposer Assembly is removed, and the Mounting Receptacle is ready to accept another Interposer Assembly.

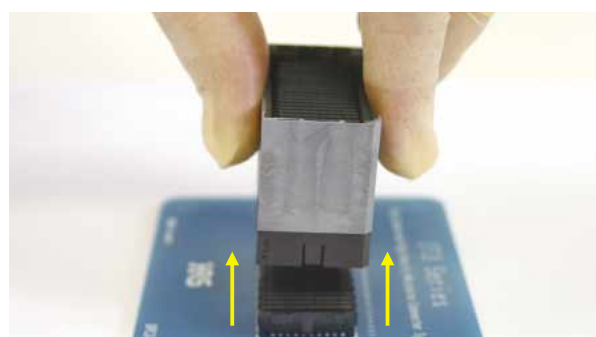

Assembly reflow soldering profile

Parameters	Eutectic (SnPb)	Pb-Free	Comment
Preheat Ramp Rate	2 - 3°C/sec	2 - 3°C/sec	Other components may limit ramp rate to 2°C/sec
Soak Time	0 - 120 sec	0 - 120 sec	Soak requirements determined by board design, oven capability, and paste activation requirements
Soak Temperature	140 - 180°C	160 - 215°C	Caution - "oversoaking" may exhaust flux and affect soldering
Peak Reflow Temperature	205 - 225°C	230 - 250°C	Cooler peak temperatures may require longer TAL's
Time Above Liquidus (TAL)	30 - 90 sec	45 - 120 sec	Shorter TAL's may require higher peak temperatures
Cooling Rate	>6°C/sec	>6°C/sec	Faster cooling rates produce finer grain structures and smoother joint appearances
Maximum Package Body Temperature (T)	240°C	260°C	Open body design allows for low delta T between package and solder joint
Maximum Delta T between Body and PWB at Liquidus	10°C	10°C	Standard practice is easy to achieve with open body design
Package Body Exposure Limit at Maximum Temperature	5 sec	5 sec	Adjust profile if maximum exposure limit is approached or exceeded

Reflow Profile

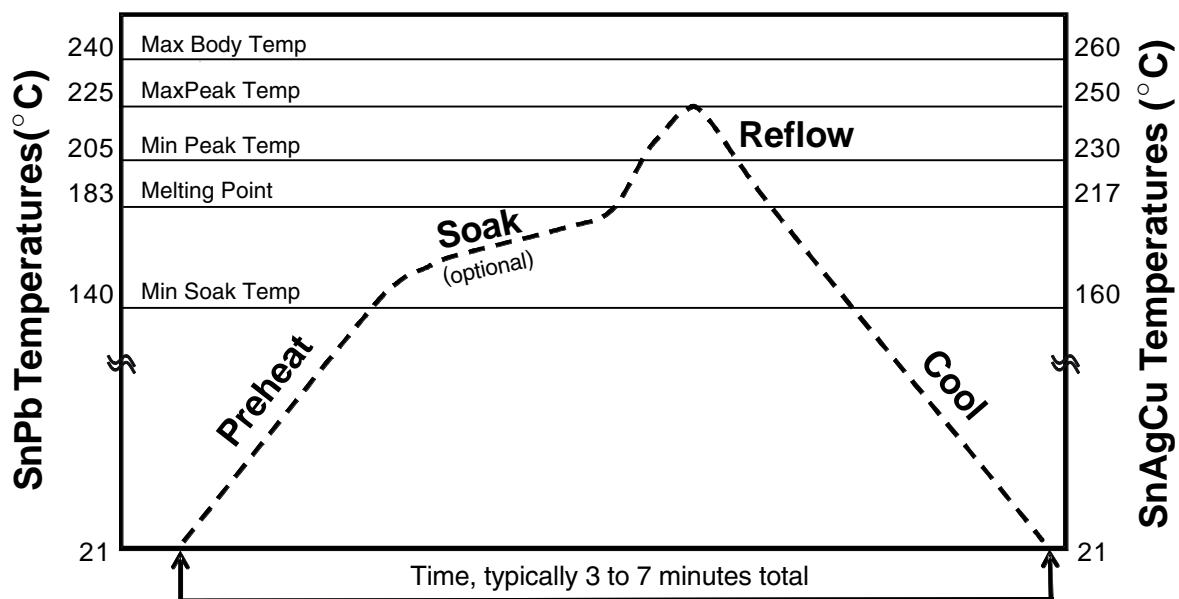

Different solder pastes have different thermal performance characteristics. Consult with paste manufacturer for optimum profile settings.

Check thermal exposure limits of PWB laminate if processing with Pb-free solder.

Mating self alignment

*Unit: mm

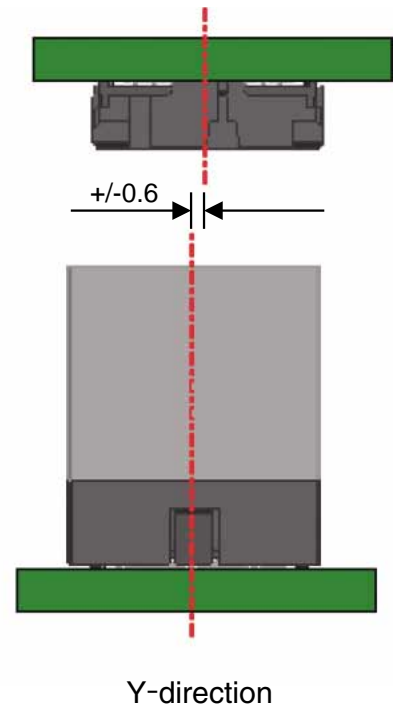
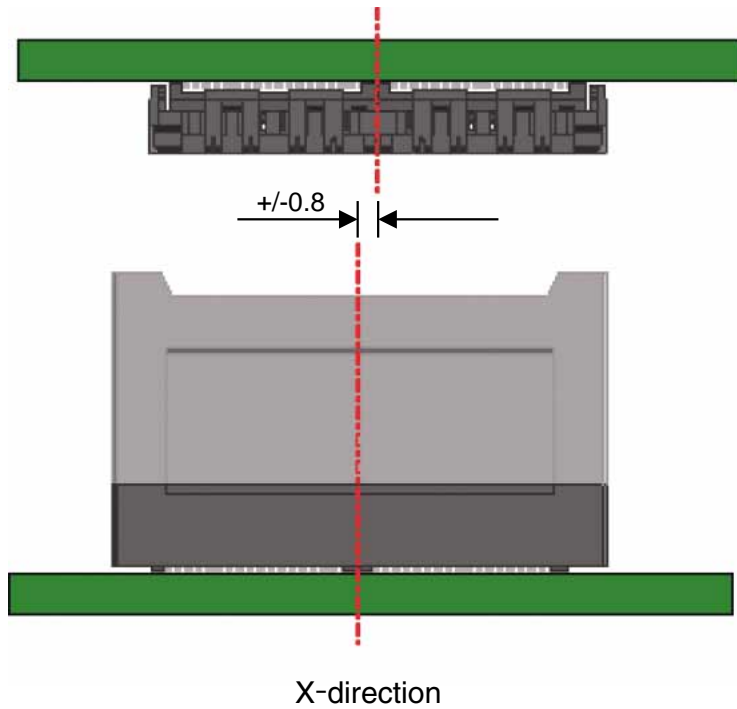

Mating tolerance

Due to its 3-piece design, the IT3 connector system can accept mating tolerances of up to ± 0.3 mm tolerance in the X-axis and up to ± 0.2 mm in the Y-axis.

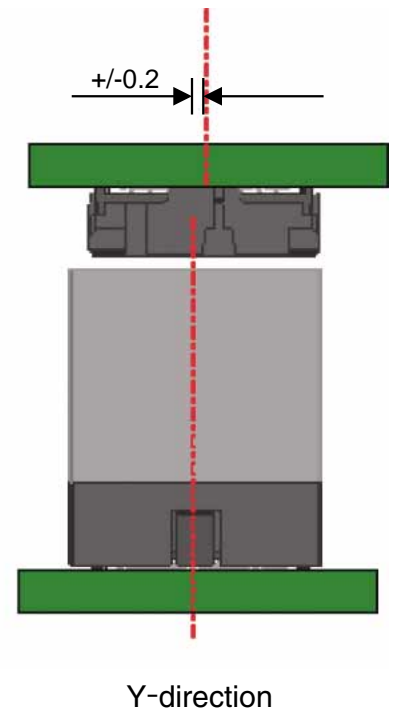
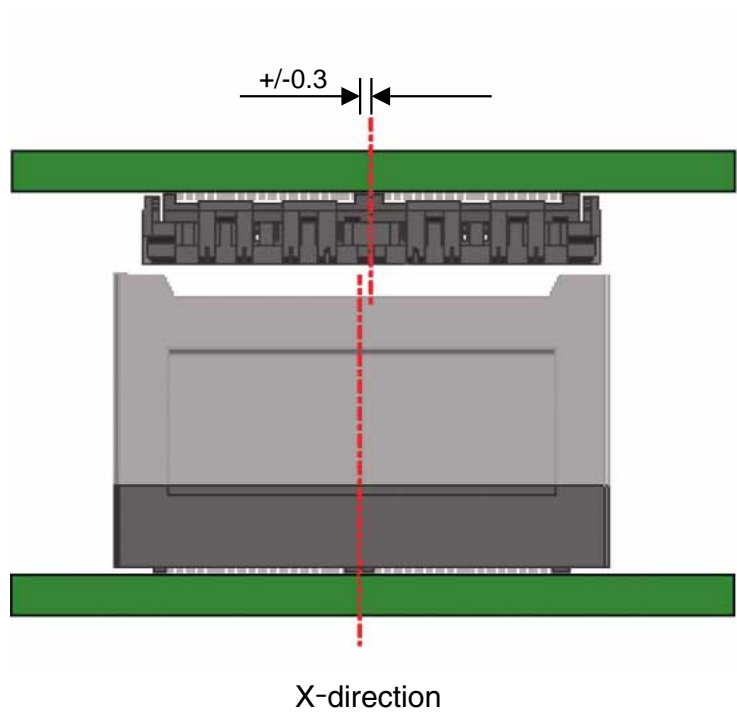

Packaging information

Please order per box with its Minimum Order Quantity (MOQ) of connectors contained.
The number for each configuration is shown below.

Receptacles

IT 3 - ***S - BGA(57)...SnPb / Au0.76μm**

IT 3 - ***S - BGA(37)...Pb-Free / Au0.76μm**

(1)

(2)

Unit: pcs

(1) \ (2)	100S	180S	200S	300S
M	120	—	72	48
D	120	—	72	48
M*	—	72	—	—
D*	—	72	—	—

This is also a packaging quantity, therefore please multiply integrally based on this MOQ quantity when you place more.

Ex.) 240pcs of IT3M-300S-BGA(57) (= 5 of vacuum packed boxes)

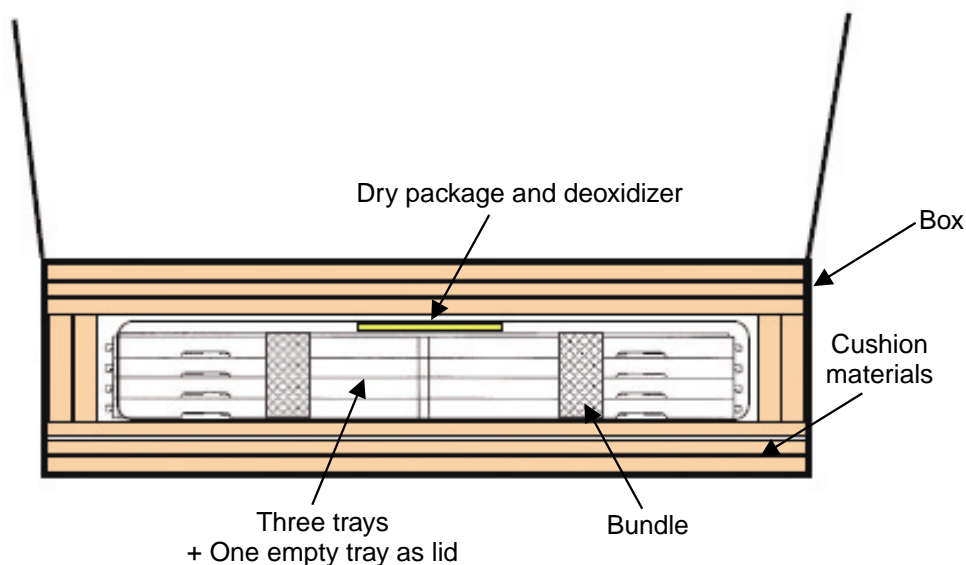

■Packaging information

●Interposers

IT 3 - ***P - **H(03)...Au0.76μm
 (3) (4)

Unit: pcs

(3) (4)	100P	180P	200P	300P
17H	—	—	80	60
20H	100	—	80	60
22H	—	—	80	60
25H	100	80	80	60
26H	100	—	80	60
28H	50	40	40	30
30H	—	—	40	30
32H	—	—	40	30
38H	50	—	40	30
40H	50	—	40	30

This is also a packaging quantity, therefore please multiply integrally based on this MOQ quantity when you place more.

Ex.) 240pcs of IT3M-300S-BGA(57) (= 5 of vacuum packed boxes)

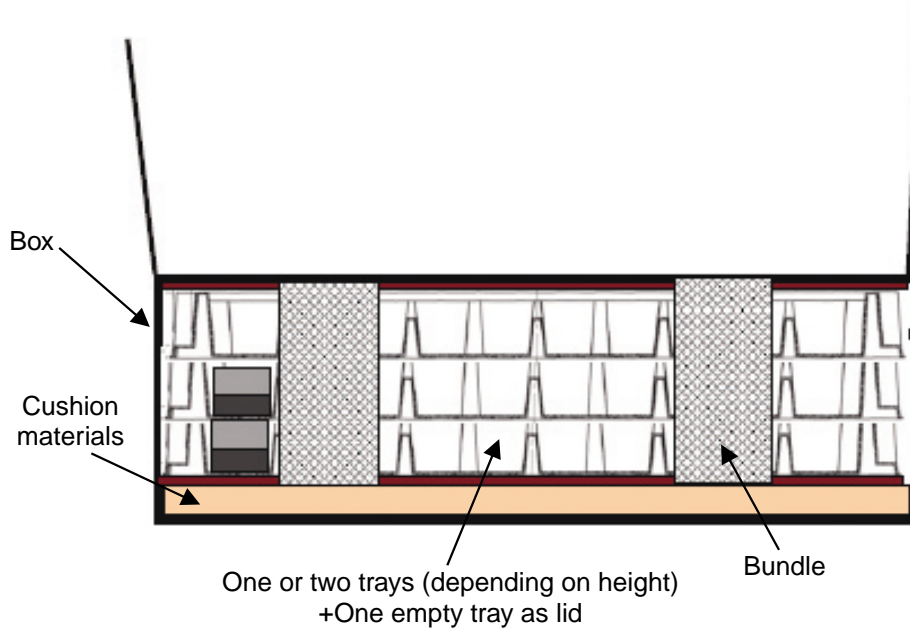

Tray information

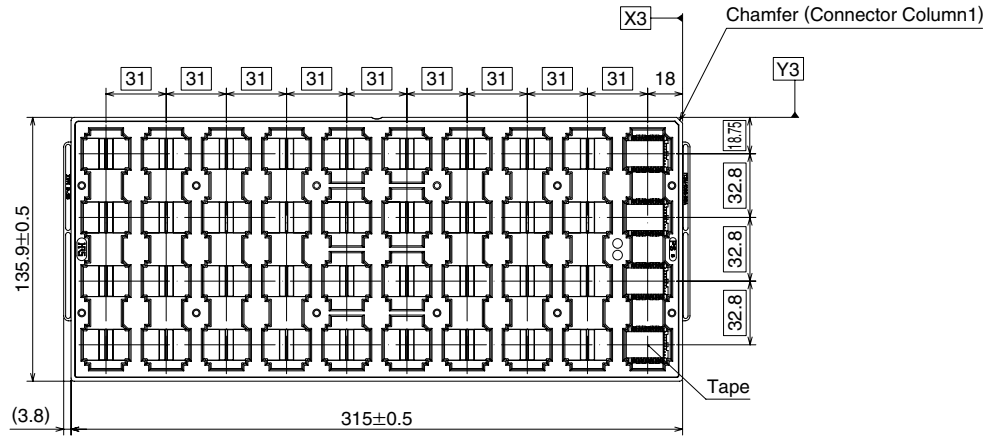

JEDEC Tray for IT3M 100 Position Receptacles

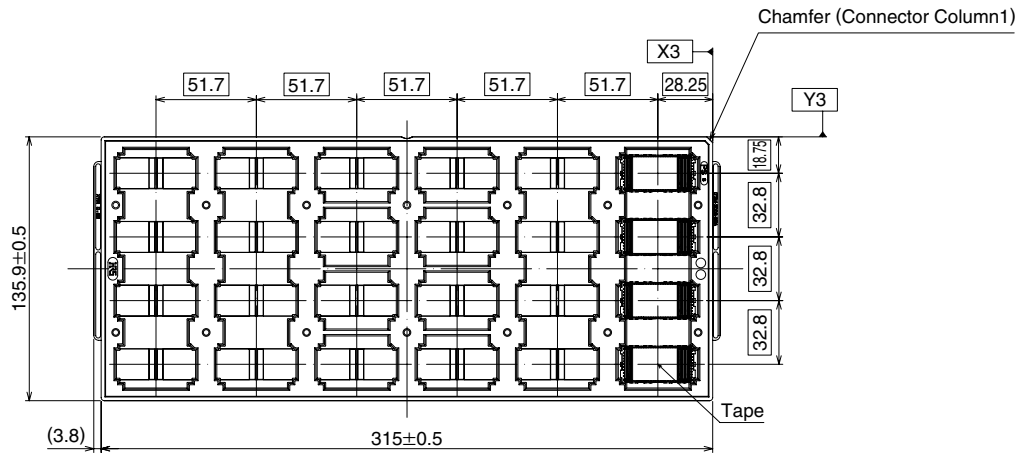

JEDEC Tray for IT3M 200 Position Receptacles

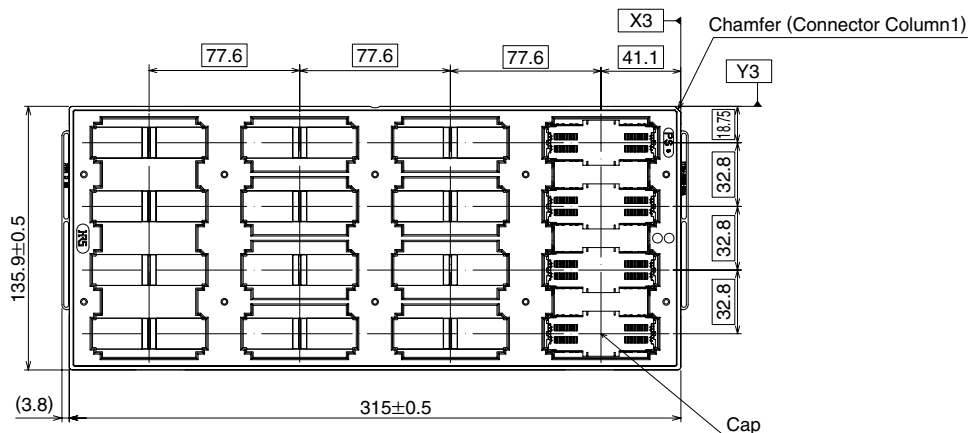

JEDEC Tray for IT3M 300 Position Receptacles

Tray information (con't)

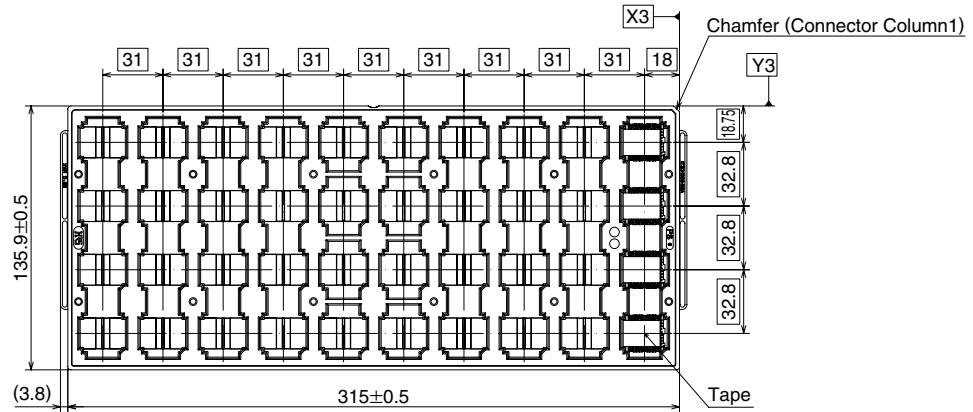

JEDEC Tray for IT3D 100 Position Receptacles

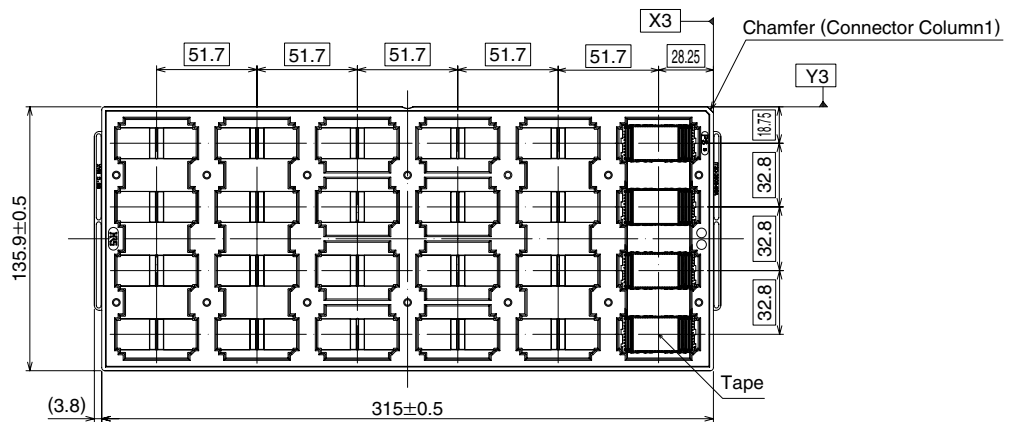

JEDEC Tray for IT3D 200 Position Receptacles

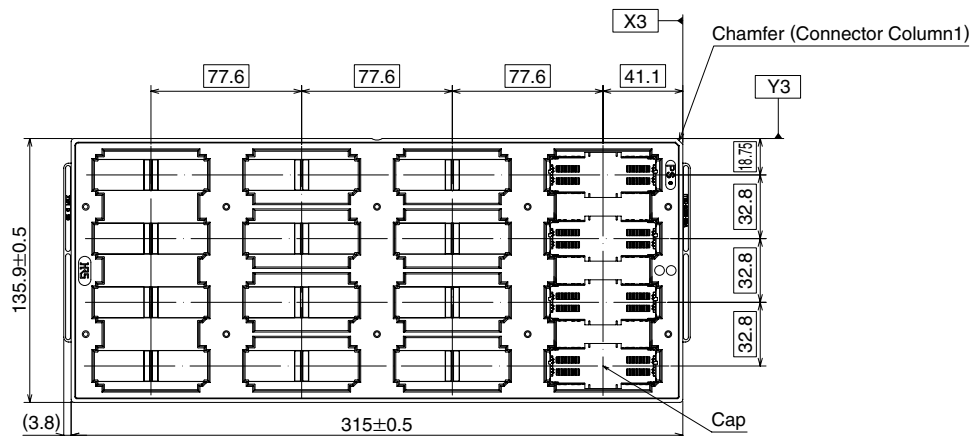

JEDEC Tray for IT3D 300 Position Receptacles

NOTES :

Lined area for notes, consisting of multiple horizontal dashed lines.

USA:
HIROSE ELECTRIC (U.S.A.), INC. Headquarters
 2688 Westhills Court, Simi Valley, CA 93065-6235
 Phone : 1-805-522-7958
 Fax : 1-805-522-3217
<http://www.hiroseusa.com>

USA:
HIROSE ELECTRIC (U.S.A.), INC. North California Office
 20400 Stevens Creek Blvd., Ste 250, Cupertino, CA 95014
 Phone : 1-408-253-9640
 Fax : 1-408-253-9641
<http://www.hiroseusa.com>

USA:
HIROSE ELECTRIC (U.S.A.), INC. Dallas Office
 1701 N. Greenville Ave. Ste 817, Richardson, TX 75081
 Phone : 1-469-330-9200
 Fax : 1-469-330-9205
<http://www.hiroseusa.com>

USA:
HIROSE ELECTRIC (U.S.A.), INC. Chicago Office
 2777 Finley Road, Suite 19 Downers Grove, IL 60515
 Phone : 1-630-916-1455
 Fax : 1-630-916-1451
<http://www.hiroseusa.com>

USA:
HIROSE ELECTRIC (U.S.A.), INC. New York Office
 510 Broadhollow Road, Suite 305, Melville, NY 11747
 Phone : 1-516-249-5259
<http://www.hiroseusa.com>

USA:
HIROSE ELECTRIC (U.S.A.), INC. Detroit Office (Automotive)
 37650 Professional Center Drive, Suite 120A, Livonia, MI 48154
 Phone : 1-734-542-9963
 Fax : 1-734-542-9964
<http://www.hiroseusa.com>

GERMANY:
HIROSE ELECTRIC GmbH
 Herzog-Carl-Strasse 4 D-73760 Ostfildern (Scharnhauser Park)
 Phone : 49-711-4560-02-1
 Fax : 49-711-4560-02-299
<http://www.hirose.de>

THE NETHERLANDS:
HIROSE ELECTRIC EUROPE B.V.
 Hogehillweg #8 1101 CC Amsterdam Z-O
 Phone : 31-20-6557490
 Fax : 31-20-6557469
<http://www.hiroseeurope.com>

FINLAND:
HIROSE ELECTRIC EUROPE B.V. FINLAND OFFICE
 Teknobulevardi 3-5 01530 VANTAA
 Phone : 358-46-712-2178
 Fax : 358-46-712-2179
<http://www.hiroseeurope.com>

UNITED KINGDOM:
HIROSE ELECTRIC UK LTD.
 First Floor, St Andrews House, Caldecotte Lake Business Park, Milton Keynes MK7 8LE
 Phone : 44-1908-369060
 Fax : 44-1908-369078
<http://www.hirose.co.uk>

CHINA:
HIROSE ELECTRIC CO., LTD. BEIJING REPRESENTATIVE OFFICE
 A1205, Ocean International Center, Building 56# East 4th Ring Middle Road, Chao Yang District, Beijing, 100025
 Phone : 86-10-5165-9332
 Fax : 86-10-5908-1381
<http://www.hirose-china.com.cn>

CHINA:
HIROSE ELECTRIC (SHANGHAI) CO., LTD.
 1501-02, Cross Tower Building, 318 Fuzhou Road, Huang Pu District, Shanghai 200001
 Phone : 86-21-6391-3355
 Fax : 86-21-6391-3335
<http://www.hirose-china.com.cn>

CHINA:
HIROSE ELECTRIC CO., LTD. SHENZHEN OFFICE
 Room 1902-05, Office Tower Shun Hing Square, Di Wang Commercial Centre 5002, ShenNanDong Road, ShenZhen City, Guangdong Province, 518008
 Phone : 86-755-8207-0851
 Fax : 86-755-8207-0873
<http://www.hirose-china.com.cn>

HONG KONG:
HIROSE ELECTRIC HONGKONG TRADING CO., LTD.
 Unit 1102 A&B, Energy Plaza, 92 Granville Road, Tsim Sha Tsui East, Kowloon
 Phone : 852-2803-5338
 Fax : 852-2591-6560
<http://www.hirose-hongkong.com.hk>

TAIWAN:
HIROSE ELECTRIC TAIWAN CO., LTD.
 No.28 Lane 247 Sec. 2, Yen Ping N, Rd. Taipei
 Phone : 886-2-2557-7351,7352
 Fax : 886-2-2552-9851
<http://www.hirose-taiwan.com.tw>

SINGAPORE:
HIROSE ELECTRIC CO., LTD. Singapore Branch
 10 Anson Road #26-16 International Plaza 079903
 Phone : 65-6324-6113
 Fax : 65-6324-6123
<http://www.hirose-singapore.com.sg>

KOREA:
HIROSE KOREA CO., LTD.
 1261-10, Jeoungwhang-Dong, Shihung-City, Kyunggi-Do 429-450
 Phone : 82-31-496-7000,7124
 Fax : 82-31-496-7100
<http://www.hirose.co.kr>



HIROSE ELECTRIC CO.,LTD.

5-23,OSAKI 5-CHOME,SHINAGAWA-KU,TOKYO 141-8587,JAPAN
 PHONE: 81-3-3491-5300, FAX: 81-3-3495-5230
<http://www.hirose.com>
<http://www.hirose-connectors.com>