

Top View

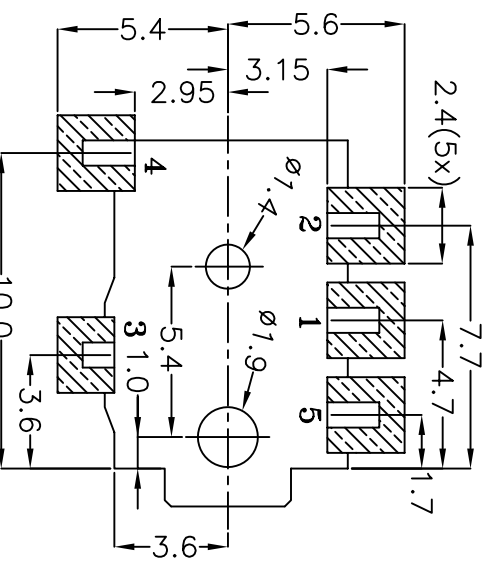

PCB Pad Layout
Top View

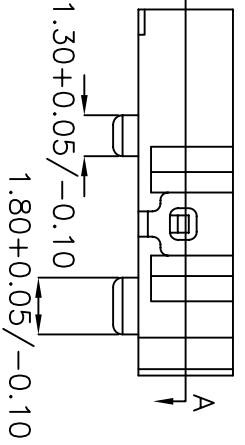

Side View

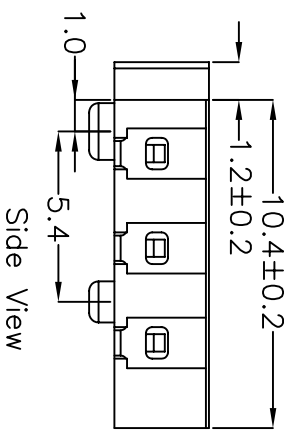

Side View

- Specifications:
1. Rated Voltage – 16 VDC
 2. Rated Current – 300 mA
 3. Contact Resistance – 100 mOHMS or less under all conditions, including After Life Testing.
 4. Insulation Resistance – 100 MOHMS or greater at 250 VDC.
 5. Dielectric Withstand Voltage – 250 VAC RMS for 1 minute.

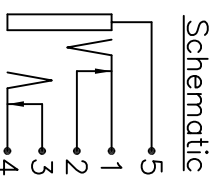

Schematic

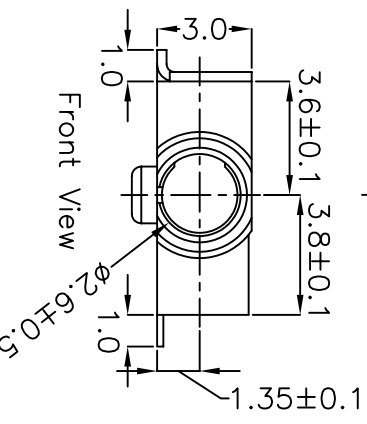

Front View

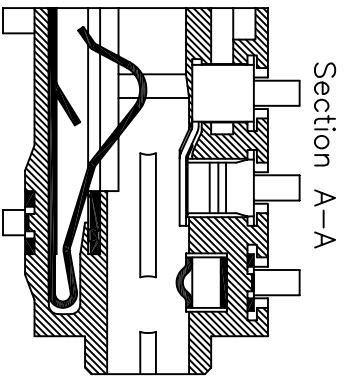

Section A-A

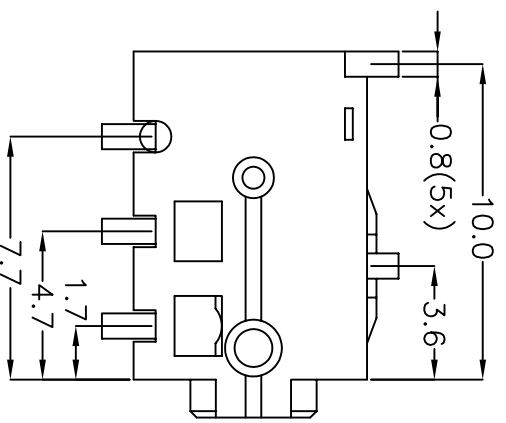

Bottom View

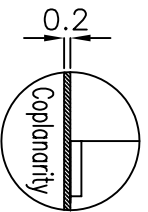

Mounting Surface

Term	Material	Color	Plating	Remark
Plastic Housing <P1>	Polyamide	Black		UL94V-0 Rated
Ring Contact <M1>	Ti-Cu Alloy		Gold Flash	20T
Shunt Ring <M2>	PBS		Gold Flash	20T
Shunt (Tip) <M3>	Brass		Gold Flash	30T
Tip Contact <M4>	Ti-Cu Alloy		Gold Flash	20T
Ground <M5>	Ti-Cu Alloy		Gold Flash	20T



9615 SW Allen, Suite 103
Beaverton, OR 97005
Phone: (503) 643-4899
800-275-4899
Fax: (503) 372-1266
Website: www.cui.com

TITLE: 2.50 Surface Mount Jack - Stereo

PART NO. SJ-2535-SMT UNITS: Millimeters

DRAWN BY: Todd R. White APPROVED BY: SCALE: 4X