

CIRCUITRY
 I - SCHEMATIC I
 2A - SCHEMATIC III
 2B - SCHEMATIC IV
 4B - SCHEMATIC XII

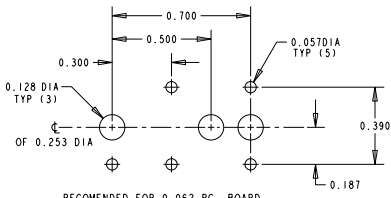

MATERIALS:
 HOUSING - THERMOPLASTIC, VALOX
 SPRINGS - NICKEL SILVER, SILVER PLATED
 CONTACTS - INTEGRAL, PART OF SHUNT SPRING

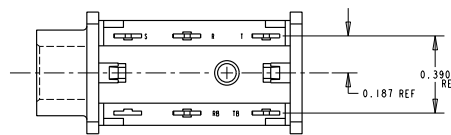
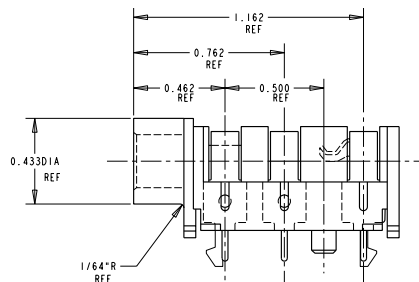
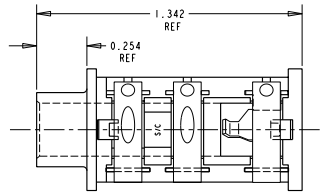
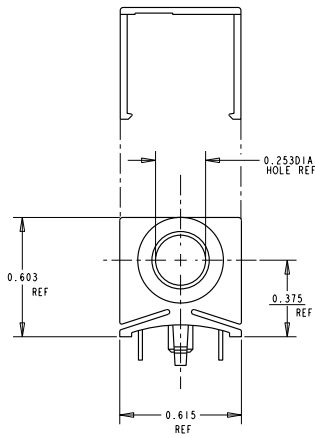
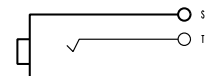

I SCHEMATIC

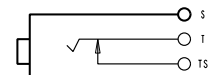

III SCHEMATIC

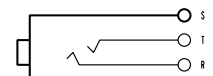

IV SCHEMATIC

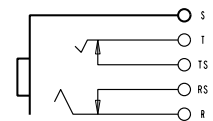

XII SCHEMATIC

CUSTOMER DRAWING
 CAD/CAM DWG. NO.
 s.sn37a1_c.d
 SHEET 1 OF 1

★ STAR SYMBOL DENOTES CRITICAL DIMENSION. SEE SPC ENGINEERING STANDARD ES-0001 UNLESS OTHERWISE SPECIFIED				THIS DRAWING DESCRIBES A DESIGN CONSIDERED PROPRIETARY IN NATURE, DEVELOPED AND MANUFACTURED BY SWITCHCRAFT, INC. AND IS RELEASED ON A CONFIDENTIAL BASIS FOR IDENTIFICATION PURPOSE ONLY.			
FINISH	SIZE	WIDTH	MOLT	MATERIAL	TEMPER	SPEC. NO.	
FIRST USED ON				SCALE			
DATE DRAWN				BY	CHK'D	APP'D	Switchcraft®
10-1-94				ES	ES	GRJ	
NAME				PHONE JACK		PART NO.	ISSUE
REVISIONS				DO NOT SCALE DRAWING		SN37A1	A

