

# Notice for TAIYO YUDEN products

Please read this notice before using the TAIYO YUDEN products.

## REMINDERS

- Product information in this catalog is as of October 2008. All of the contents specified herein are subject to change without notice due to technical improvements, etc. Therefore, please check for the latest information carefully before practical application or usage of the Products.

Please note that Taiyo Yuden Co., Ltd. shall not be responsible for any defects in products or equipment incorporating such products, which are caused under the conditions other than those specified in this catalog or individual specification.

- Please contact Taiyo Yuden Co., Ltd. for further details of product specifications as the individual specification is available.
- Please conduct validation and verification of products in actual condition of mounting and operating environment before commercial shipment of the equipment.

- All electronic components or functional modules listed in this catalog are developed, designed and intended for use in general electronics equipment.(for AV, office automation, household, office supply, information service, telecommunications, (such as mobile phone or PC) etc.). Before incorporating the components or devices into any equipment in the field such as transportation,( automotive control, train control, ship control), transportation signal, disaster prevention, medical, public information network (telephone exchange, base station) etc. which may have direct influence to harm or injure a human body, please contact Taiyo Yuden Co., Ltd. for more detail in advance.

Do not incorporate the products into any equipment in fields such as aerospace, aviation, nuclear control, submarine system, military, etc. where higher safety and reliability are especially required.

In addition, even electronic components or functional modules that are used for the general electronic equipment, if the equipment or the electric circuit require high safety or reliability function or performances, a sufficient reliability evaluation check for safety shall be performed before commercial shipment and moreover, due consideration to install a protective circuit is strongly recommended at customer's design stage.

- The contents of this catalog are applicable to the products which are purchased from our sales offices or distributors (so called "TAIYO YUDEN' s official sales channel"). It is only applicable to the products purchased from any of TAIYO YUDEN' s official sales channel.

- Please note that Taiyo Yuden Co., Ltd. shall have no responsibility for any controversies or disputes that may occur in connection with a third party's intellectual property rights and other related rights arising from your usage of products in this catalog. Taiyo Yuden Co., Ltd. grants no license for such rights.

### ■ Caution for export

Certain items in this catalog may require specific procedures for export according to "Foreign Exchange and Foreign Trade Control Law" of Japan, "U.S. Export Administration Regulations," and other applicable regulations. Should you have any question or inquiry on this matter, please contact our sales staff.

Should you have any question or inquiry on this matter, please contact our sales staff.

# 積層チップバリスタ (一般)

## MULTILAYER CHIP VARISTORS(STANDARD TYPE)



リフロー/REFLOW

OPERATING TEMP.	1005TYPE	-55~+125°C
	0603TYPE	-40~+85°C

### 特長 FEATURES

- すぐれた応答性により、急峻な静電気放電 (ESD) を効果的に対策できます。
- 電圧電流特性に極性がないため、1素子で双方向の対策効果が得られます。
- 高い静電気耐圧を有し、静電気印加後の特性劣化がありません。
- 1005 (0402)、0603 (0201)、形状により実装密度の向上がはかれます。
- High speed response realizes effective countermeasure for acute ESD.
- No polarity makes effective countermeasure for both directions with one component.
- High resistance to static electricity keeps high performance after static electricity applied.
- 1005 (0402), 0603 (0201) case size contributes to designing for high density mounting device.

### 用途 APPLICATIONS

- 静電気放電 (ESD) 保護
- ESD (Electric static discharge) protection.

### 形名表記法 ORDERING CODE

<p><b>1</b></p> <table border="1"> <tr><td>形式</td></tr> <tr><td>VR△ 積層チップバリスタ</td></tr> <tr><td>△=スペース</td></tr> </table>	形式	VR△ 積層チップバリスタ	△=スペース	<p><b>3</b></p> <table border="1"> <tr><td>静電容量記号を表す</td></tr> <tr><td>A 一般品</td></tr> <tr><td>B以降 特殊品</td></tr> </table>	静電容量記号を表す	A 一般品	B以降 特殊品	<p><b>5</b></p> <table border="1"> <tr><td>特殊仕様記号</td></tr> <tr><td>A 一般品</td></tr> </table>	特殊仕様記号	A 一般品	<p><b>7</b></p> <table border="1"> <tr><td>包装形態</td></tr> <tr><td>-T テーピング</td></tr> <tr><td>-B バルク</td></tr> </table>	包装形態	-T テーピング	-B バルク			
形式																	
VR△ 積層チップバリスタ																	
△=スペース																	
静電容量記号を表す																	
A 一般品																	
B以降 特殊品																	
特殊仕様記号																	
A 一般品																	
包装形態																	
-T テーピング																	
-B バルク																	
<p><b>2</b></p> <table border="1"> <tr><td>形状寸法 (L×W) (mm)</td></tr> <tr><td>1005 (0402) 1.0×0.5</td></tr> <tr><td>0603 (0201) 0.6×0.3</td></tr> </table>	形状寸法 (L×W) (mm)	1005 (0402) 1.0×0.5	0603 (0201) 0.6×0.3	<p><b>4</b></p> <table border="1"> <tr><td>サージ電流耐量記号</td></tr> <tr><td>A 一般品</td></tr> <tr><td>B以降 特殊品</td></tr> </table>	サージ電流耐量記号	A 一般品	B以降 特殊品	<p><b>6</b></p> <table border="1"> <tr><td>公称バリスタ電圧 (V)</td></tr> <tr><td>080 8×10<sup>0</sup> [V]</td></tr> <tr><td>120 12×10<sup>0</sup> [V]</td></tr> <tr><td>180 18×10<sup>0</sup> [V]</td></tr> <tr><td>270 27×10<sup>0</sup> [V]</td></tr> </table>	公称バリスタ電圧 (V)	080 8×10 <sup>0</sup> [V]	120 12×10 <sup>0</sup> [V]	180 18×10 <sup>0</sup> [V]	270 27×10 <sup>0</sup> [V]	<p><b>8</b></p> <table border="1"> <tr><td>当社管理記号</td></tr> <tr><td>△ 標準品</td></tr> <tr><td>△=スペース</td></tr> </table>	当社管理記号	△ 標準品	△=スペース
形状寸法 (L×W) (mm)																	
1005 (0402) 1.0×0.5																	
0603 (0201) 0.6×0.3																	
サージ電流耐量記号																	
A 一般品																	
B以降 特殊品																	
公称バリスタ電圧 (V)																	
080 8×10 <sup>0</sup> [V]																	
120 12×10 <sup>0</sup> [V]																	
180 18×10 <sup>0</sup> [V]																	
270 27×10 <sup>0</sup> [V]																	
当社管理記号																	
△ 標準品																	
△=スペース																	

V R △ 1 0 0 5 A A A 1 2 0 - T △ △

<p><b>1</b></p> <table border="1"> <tr><td>Type</td></tr> <tr><td>VR△ MULTILAYER CHIP VARISTORS</td></tr> <tr><td>△=Blank space</td></tr> </table>	Type	VR△ MULTILAYER CHIP VARISTORS	△=Blank space	<p><b>3</b></p> <table border="1"> <tr><td>Capacitance</td></tr> <tr><td>A Standard products</td></tr> <tr><td>B~ Special products</td></tr> </table>	Capacitance	A Standard products	B~ Special products	<p><b>5</b></p> <table border="1"> <tr><td>Special code</td></tr> <tr><td>A Standard products</td></tr> </table>	Special code	A Standard products	<p><b>7</b></p> <table border="1"> <tr><td>Packaging</td></tr> <tr><td>-T Tape &amp; reel</td></tr> <tr><td>-B Bulk</td></tr> </table>	Packaging	-T Tape & reel	-B Bulk			
Type																	
VR△ MULTILAYER CHIP VARISTORS																	
△=Blank space																	
Capacitance																	
A Standard products																	
B~ Special products																	
Special code																	
A Standard products																	
Packaging																	
-T Tape & reel																	
-B Bulk																	
<p><b>2</b></p> <table border="1"> <tr><td>External Dimensions (L×W) (mm)</td></tr> <tr><td>1005 (0402) 1.0×0.5</td></tr> <tr><td>0603 (0201) 0.6×0.3</td></tr> </table>	External Dimensions (L×W) (mm)	1005 (0402) 1.0×0.5	0603 (0201) 0.6×0.3	<p><b>4</b></p> <table border="1"> <tr><td>Withstanding Surge Current</td></tr> <tr><td>A Standard products</td></tr> <tr><td>B~ Special products</td></tr> </table>	Withstanding Surge Current	A Standard products	B~ Special products	<p><b>6</b></p> <table border="1"> <tr><td>Varistor voltage [V]</td></tr> <tr><td>080 8×10<sup>0</sup> [V]</td></tr> <tr><td>120 12×10<sup>0</sup> [V]</td></tr> <tr><td>180 18×10<sup>0</sup> [V]</td></tr> <tr><td>270 27×10<sup>0</sup> [V]</td></tr> </table>	Varistor voltage [V]	080 8×10 <sup>0</sup> [V]	120 12×10 <sup>0</sup> [V]	180 18×10 <sup>0</sup> [V]	270 27×10 <sup>0</sup> [V]	<p><b>8</b></p> <table border="1"> <tr><td>Internal code</td></tr> <tr><td>△ Standard Products</td></tr> <tr><td>△=Blank space</td></tr> </table>	Internal code	△ Standard Products	△=Blank space
External Dimensions (L×W) (mm)																	
1005 (0402) 1.0×0.5																	
0603 (0201) 0.6×0.3																	
Withstanding Surge Current																	
A Standard products																	
B~ Special products																	
Varistor voltage [V]																	
080 8×10 <sup>0</sup> [V]																	
120 12×10 <sup>0</sup> [V]																	
180 18×10 <sup>0</sup> [V]																	
270 27×10 <sup>0</sup> [V]																	
Internal code																	
△ Standard Products																	
△=Blank space																	

## 外形寸法 EXTERNAL DIMENSIONS

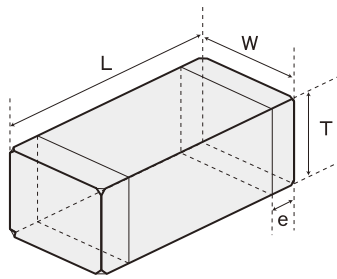

Type	L	W	T	e
1005 (0402)	1.0±0.05 (0.039±0.002)	0.5±0.05 (0.020±0.002)	0.5±0.05 (0.020±0.002)	0.25±0.10 (0.010±0.004)
0603 (0201)	0.6±0.03 (0.024±0.001)	0.3±0.03 (0.012±0.001)	0.3±0.03 (0.012±0.001)	0.15±0.05 (0.006±0.002)

Unit : mm (inch)

## アイテム一覧 PART NUMBERS

### 1005TYPE

形名 Ordering Code	EHS (Environmental Hazardous Substances)	バリスタ電圧 Varistor Voltage V1mA (V)	バリスタ電圧 許容差 Varistor voltage tolerance	定格電圧 Rated Voltage DC (V)	制限電圧 Clamping Voltage V0.1A (V)	静電気耐圧 ESD Peak Voltage 150pF 330Ω contact discharge (kV)	サージ電流耐量 Peak current 8/20μsec (A)	静電容量(参考値) Capacitance (reference value) 1kHz 1Vrms (pF)
VR1005BBA270	RoHS	27	±20%	15	46	15	10	80
VR1005AAA270	RoHS	27		15	46		5	40
VR1005CCA270	RoHS	27		15	46		1	15
VR1005AAA180	RoHS	18		10	32		10	140
VR1005AAA120	RoHS	12		7.5	22		5	130
VR1005BBA080	RoHS	8		5.5	15		25	650
VR1005DDA080	RoHS	8		5.5	15		20	480
VR1005AAA080	RoHS	8		5.5	15		3	100
VR1005CCA080	RoHS	8		4.5	17		8	1

使用温度範囲 -55~+125°C

Operating Temp

### 0603TYPE

形名 Ordering Code	EHS (Environmental Hazardous Substances)	バリスタ電圧 Varistor Voltage V1mA (V)	バリスタ電圧 許容差 Varistor voltage tolerance	定格電圧 Rated Voltage DC (V)	制限電圧 Clamping Voltage V0.1A (V)	静電気耐圧 ESD Peak Voltage 150pF 330Ω contact discharge (kV)	サージ電流耐量 Peak current 8/20μsec (A)	静電容量(参考値) Capacitance (reference value) 1kHz 1Vrms (pF)
VR0603AAA120	RoHS	12	±20%	7.5	22	8	1	33

使用温度範囲 -40~+85°C

Operating Temp

セレクションガイド  
Selection Guide



etc

アイテム一覧  
Part Numbers



P.449

特性図  
Electrical Characteristics



P.452

梱包  
Packaging



P.453

信頼性  
Reliability Data



P.454

使用上の注意  
Precautions



P.456

・I-V 特性例 Example of I vs V characteristics

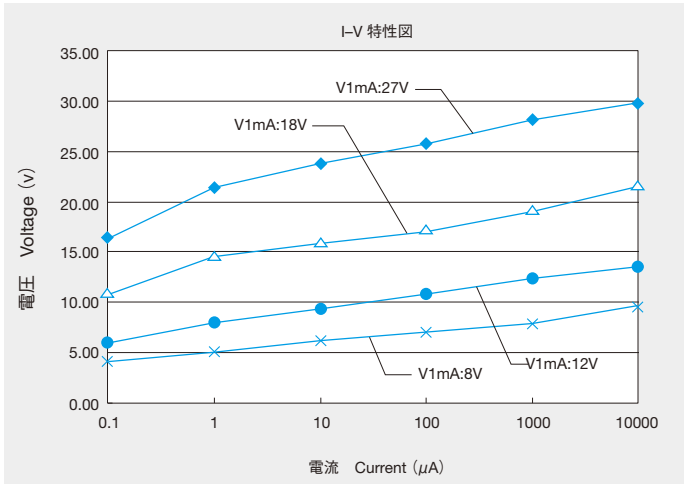

・静電気吸収波形例 Example of ESD test waveform IEC61000-4-2/330Ω 150pF contact discharge

対策前  
without varistor

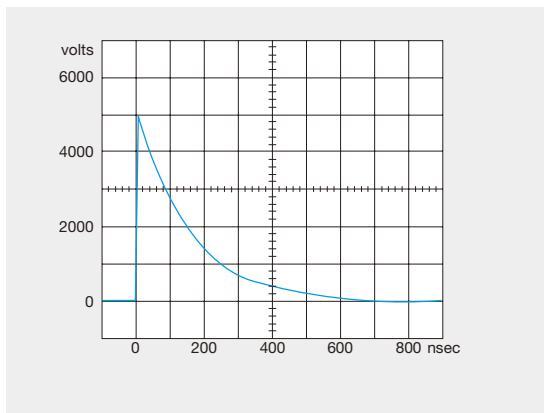

対策後 (チップバリスタVR1005AAA120使用)  
using VR1005AAA120

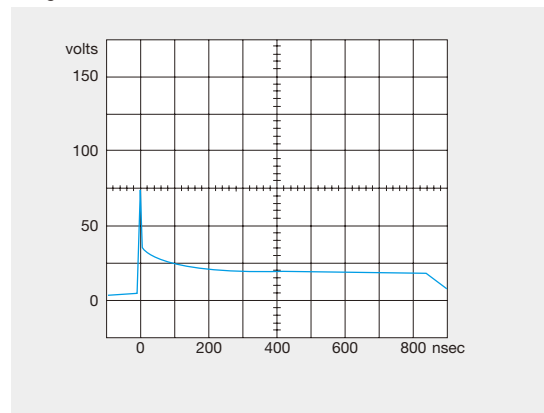

・伝送特性例 Example of transmission characteristics

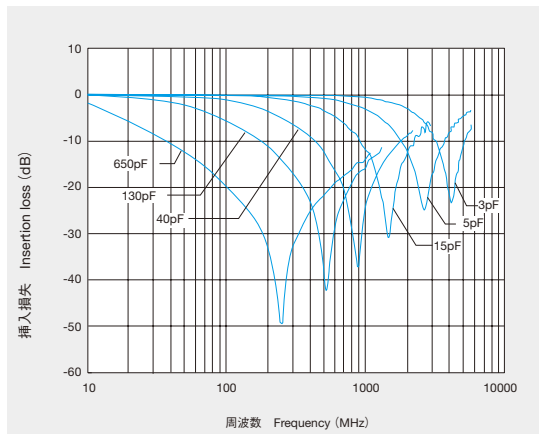

①最小受注単位数 Minimum Quantity

形式 Type	製品厚み Thickness [mm]	標準数量 Standard quantity [pcs]	
		袋づめ Bulk	紙テープ Taping
1005・105C (0402)	0.5 (0.020)	10000	10000
0603 (0201)	0.3 (0.012)	—	15000

②テーピング材質 Tape material

紙テープ  
Card board carrier tape

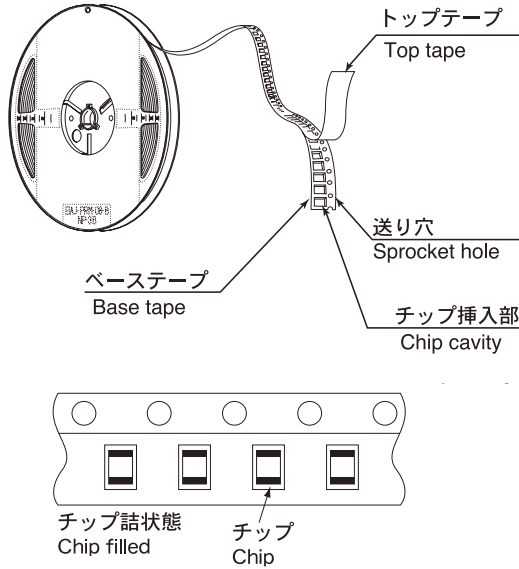

③テーピング寸法 Taping Dimensions

紙テープ (8mm幅) Paper tape (0.315inches wide)

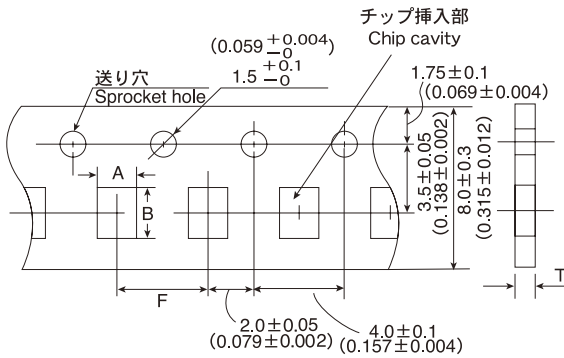

形式 Type	チップ挿入部 Chip cavity		挿入ピッチ Insertion pitch	テープ厚み Tape thickness
	A	B		
1005・105C (0402)	0.65 ± 0.1 (0.026 ± 0.004)	1.15 ± 0.1 (0.045 ± 0.004)	2.0 ± 0.05 (0.079 ± 0.002)	0.80 max (0.031 max)
0603 (0201)	0.40 ± 0.06 (0.016 ± 0.002)	0.70 ± 0.06 (0.028 ± 0.002)	2.0 ± 0.05 (0.079 ± 0.002)	0.45 max (0.018 max)

Unit : mm (Inch)

④リーダー部・空部 Leader and Blank portion

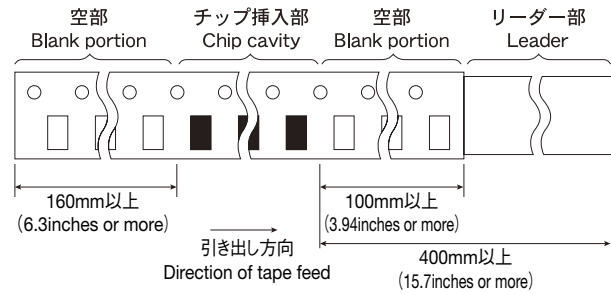

⑤リール寸法 Reel size

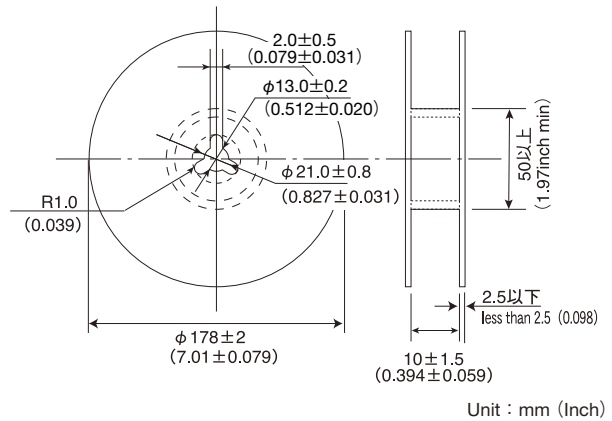

⑥トッテープ強度 Top Tape Strength

トッテープのはがし力は下図矢印方向にて0.1~0.7Nとなります。  
The top tape requires a peel-off force of 0.1~0.7N in the direction of the arrow as illustrated below.

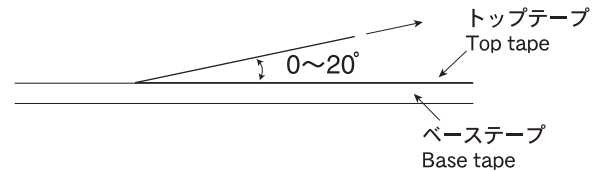

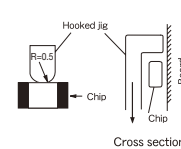
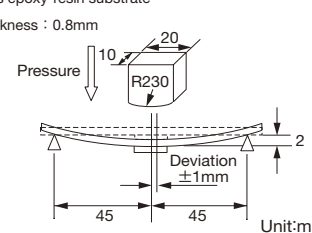
Item	Specified Value	Test Methods and Remarks
1. Operating Temperature Range	VR1005 : -55~+125°C VR0603, VR105C : -40~+85°C	
2. Storage Temperature Range	-55~+125°C	
3. Rated voltage	Refer to part number section.	Maximum DC for continuous application within operating temperature range
4. Varistor voltage	Refer to part number section.	Voltage between terminals at application of DC 1mA
5. Clamp voltage	Refer to part number section.	8/20 μs 0.1A
6. Capacitance	Refer to part number section.	Measured at specified measuring frequency, 1 Vrms, 0V bias
7. ESD Peak voltage	Refer to part number section.	150pF 330Ω contact discharge (IEC61000-4-2) Maximum ESD voltage that can be withstood without deteriorating varistor characteristics when an ESD voltage is applied once.
8. Withstanding surge current	Refer to part number section.	Maximum current that can be withstood without deteriorating varistor characteristics when an impulse current (8/20 μs) is applied once.
9. High Temperature Loading	VR1005, 0603 : ΔV1mA/V1mA ≤ ±10% VR105C : ΔCp/Cp ≤ ±30%	VR1005 : 125±3°C, Rated voltage, 500h±12h VR0603, VR105C : 85±3°C, Rated voltage, 500h±12h
10. Humidity Loading	VR1005, 0603 : ΔV1mA/V1mA ≤ ±10% VR105C : ΔCp/Cp ≤ ±30%	40±2°C, 90 to 95% RH, Rated voltage, 500h±12h
11. Thermal Shock	No mechanical damage VR1005, 0603 : ΔV1mA/V1mA ≤ ±10% VR105C : ΔCp/Cp ≤ ±30%	Conditions for 1 cycle Step1 : Minimum operating temperature +0-3°C 30±3min. Step2 : Room temperature 2 to 3 min. Step3 : Maximum operating temperature +0-3°C 30±3min. Step4 : Room temperature 2 to 3 min. Number of cycles : 5
12. Solderability	More than 75% of the termination shall be covered with fresh solder.	235 ±5°C, 2±0.5 sec. Solder: H63A Flux: Rosin ethanol solution (25wt%)
13. Resistance to Soldering Heat	No mechanical damage such as crack VR1005, 0603 : ΔV1mA/V1mA ≤ ±10% VR105C : ΔCp/Cp ≤ ±30%	260 ±5°C, 10±1 sec. Solder: H63A Flux: Rosin ethanol solution (25wt%)
14. Adhesive force of terminal electrodes	Without electrode peeling	(Type : 1005, 105C) After samples have been soldered to the PCB, a force of 5N (0.51kgf) in the horizontal direction shall be applied for 10±1 seconds as shown in below diagram. (Type : 0603) After samples have been soldered to the PCB, a force of 2N (0.20kgf) in the horizontal direction shall be applied for 10±1 seconds as shown in below diagram. 
15. Bending strength	No mechanical damage	Warp : 2mm Testing board : glass epoxy-resin substrate Thickness : 0.8mm 

Note on standard condition: "standard condition" referred to herein is defined as follows 5 to 35°C of temperature, 45 to 85% relative humidity and 86 to 106kPa of air pressure.

When there are questions concerning measurement result: In order to provide correlation data, the test shall be conducted under condition of 20±2°C of temperature, 60 to 70% relative humidity and 86 to 106kPa of air pressure.

Unless otherwise specified, all the tests are conducted under the "standard condition".

Precautions on the use of Multilayer chip varistors.

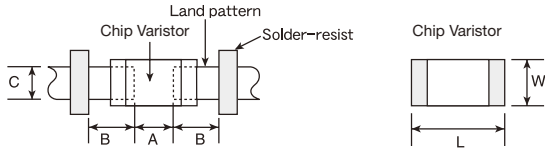
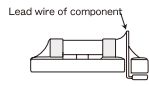
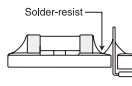
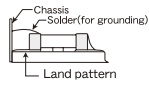
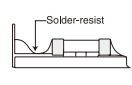
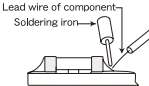
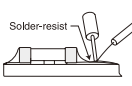
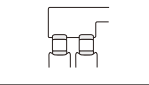
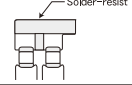
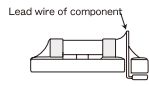
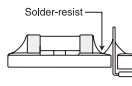
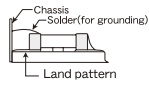
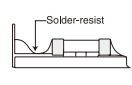
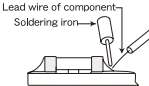
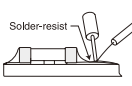
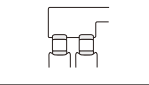
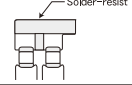
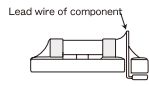
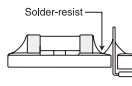
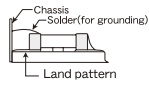
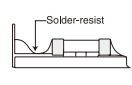
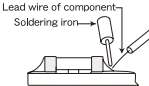
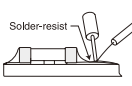
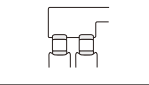
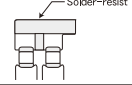
Stages	Precautions	Technical considerations																																												
1.Circuit Design	<p>Verification of operating environment, electrical rating and performance</p> <p>1.A malfunction in medical equipment, spacecraft, nuclear reactors, etc. may cause serious harm to human life or have severe social ramifications. As such, any varistors to be used in such equipment may require higher safety and/or reliability considerations and should be clearly differentiated from components used in general purpose applications.</p> <p>Operating Voltage (Verification of Rated voltage)</p> <p>1.The operating voltage for varistors must always be lower than their rated values.</p> <p>If an AC voltage is loaded on a DC voltage, the sum of the two peak voltages should be lower than the rated value of the varistor chosen. For a circuit where both an AC and a pulse voltage may be present, the sum of their peak voltages should also be lower than the varistor's rated voltage.</p>																																													
2.PCB Design	<p>Pattern configurations (Design of Land-patterns)</p> <p>1.When varistors are mounted on a PCB, the amount of solder used (size of fillet) can directly affect varistor performance.</p> <p>Therefore, the following items must be carefully considered in the design of solder land patterns:</p> <p>(1)The amount of solder applied can affect the ability of chips to withstand mechanical stresses which may lead to breaking or cracking. Therefore, when designing land-patterns it is necessary to consider the appropriate size and configuration of the solder pads which in turn determines the amount of solder necessary to form the fillets.</p> <p>(2)When more than one part is jointly soldered onto the same land or pad, the pad must be designed so that each component's soldering point is separated by solder-resist.</p>	<p>1.The following diagrams and tables show some examples of recommended patterns to prevent excessive solder amounts. (larger fillets which extend above the component end terminations)</p> <p>Examples of improper pattern designs are also shown.</p> <p>(1)Recommended land dimensions for a typical chip varistor land patterns for PCBs</p>  <p>Recommended land dimensions for reflow-soldering (unit: mm)</p> <table border="1" data-bbox="889 1094 1182 1272"> <thead> <tr> <th>Type</th> <th colspan="2">0603</th> <th colspan="2">1005,105C</th> </tr> </thead> <tbody> <tr> <td rowspan="2">Size</td> <td>L</td> <td>0.6</td> <td colspan="2">1.0</td> </tr> <tr> <td>W</td> <td>0.3</td> <td colspan="2">0.5</td> </tr> <tr> <td>A</td> <td colspan="2">0.2~0.30</td> <td colspan="2">0.45~0.55</td> </tr> <tr> <td>B</td> <td colspan="2">0.2~0.30</td> <td colspan="2">0.40~0.50</td> </tr> <tr> <td>C</td> <td colspan="2">0.25~0.40</td> <td colspan="2">0.45~0.55</td> </tr> </tbody> </table> <p>Excess solder can affect the ability of chips to withstand mechanical stresses. Therefore, please take proper precautions when designing land-patterns.</p> <p>(2)Examples of good and bad solder application</p> <table border="1" data-bbox="867 1394 1446 1808"> <thead> <tr> <th>Items</th> <th>Not recommended</th> <th>Recommended</th> </tr> </thead> <tbody> <tr> <td>Mixed mounting of SMD and leaded components</td> <td></td> <td></td> </tr> <tr> <td>Component placement close to the chassis</td> <td></td> <td></td> </tr> <tr> <td>Hand-soldering of leaded components near mounted components</td> <td></td> <td></td> </tr> <tr> <td>Horizontal component placement</td> <td></td> <td></td> </tr> </tbody> </table>	Type	0603		1005,105C		Size	L	0.6	1.0		W	0.3	0.5		A	0.2~0.30		0.45~0.55		B	0.2~0.30		0.40~0.50		C	0.25~0.40		0.45~0.55		Items	Not recommended	Recommended	Mixed mounting of SMD and leaded components			Component placement close to the chassis			Hand-soldering of leaded components near mounted components			Horizontal component placement		
Type	0603		1005,105C																																											
Size	L	0.6	1.0																																											
	W	0.3	0.5																																											
A	0.2~0.30		0.45~0.55																																											
B	0.2~0.30		0.40~0.50																																											
C	0.25~0.40		0.45~0.55																																											
Items	Not recommended	Recommended																																												
Mixed mounting of SMD and leaded components																																														
Component placement close to the chassis																																														
Hand-soldering of leaded components near mounted components																																														
Horizontal component placement																																														

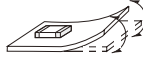
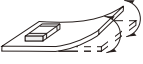
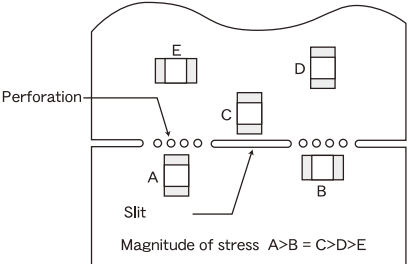
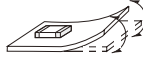
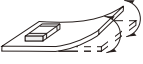
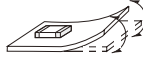
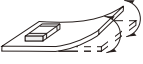
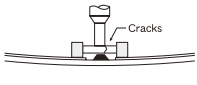
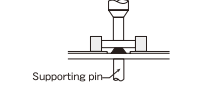
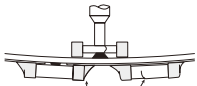
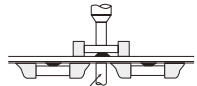
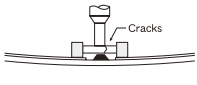
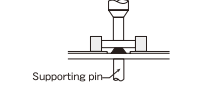
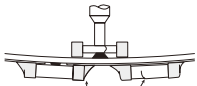
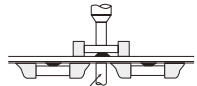
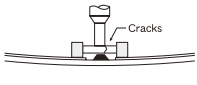
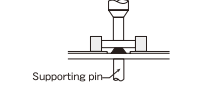
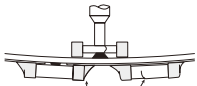
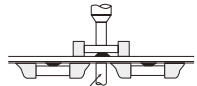

Precautions on the use of Multilayer chip varistors.

Stages	Precautions	Technical considerations									
<p>2.PCB Design</p>	<p>Pattern configurations (varistor layout on panelized [breakaway] PC boards)</p> <p>1.After varistors have been mounted on the boards, chips can be subjected to mechanical stresses in subsequent manufacturing processes (PCB cutting, board inspection, mounting of additional parts, assembly into the chassis, wave soldering the reflow soldered boards etc. For this reason, planning pattern configurations and the position of SMD varistors should be carefully performed to minimize stress.</p>	<p>1-1.The following are examples of good and bad varistor layout; SMD varistors should be located to minimize any possible mechanical stresses from board warp or deflection.</p> <table border="1" data-bbox="868 325 1446 472"> <thead> <tr> <th></th> <th>Not recommended</th> <th>Recommended</th> </tr> </thead> <tbody> <tr> <td>Deflection of the board</td> <td></td> <td></td> </tr> </tbody> </table> <p>1-2.To layout the varistors for the breakaway PC board, it should be noted that the amount of mechanical stresses given will vary depending on varistor layout. The example below shows recommendations for better design.</p>  <p>Magnitude of stress <math>A &gt; B = C &gt; D &gt; E</math></p> <p>1-3.When breaking PC boards along their perforations, the amount of mechanical stress on the varistors can vary according to the method used. The following methods are listed in order from least stressful to most stressful: push-back, slit, V-grooving, and perforation. Thus, any ideal SMD varistor layout must also consider the PCB splitting procedure.</p>		Not recommended	Recommended	Deflection of the board					
	Not recommended	Recommended									
Deflection of the board											
<p>3.Considerations for automatic placement</p>	<p>Adjustment of mounting machine</p> <p>1.Excessive impact load should not be imposed on the varistors when mounting onto the PC boards.</p> <p>2.The maintenance and inspection of the mounters should be conducted periodically.</p>	<p>1.If the lower limit of the pick-up nozzle is low, too much force may be imposed on the capacitors, causing damage. To avoid this, the following points should be considered before lowering the pick-up nozzle:</p> <ol style="list-style-type: none"> <li>(1) The lower limit of the pick-up nozzle should be adjusted to the surface level of the PC board after correcting for deflection of the board.</li> <li>(2) The pick-up pressure should be adjusted between 1 and 3 N static loads.</li> <li>(3) To reduce the amount of deflection of the board caused by impact of the pick-up nozzle, supporting pins or back-up pins should be used under the PC board. The following diagrams show some typical examples of good pick-up nozzle placement:</li> </ol> <table border="1" data-bbox="868 1260 1446 1522"> <thead> <tr> <th></th> <th>Not recommended</th> <th>Recommended</th> </tr> </thead> <tbody> <tr> <td>Single-sided mounting</td> <td></td> <td></td> </tr> <tr> <td>Double-sided mounting</td> <td></td> <td></td> </tr> </tbody> </table> <p>2.As the alignment pin wears out, adjustment of the nozzle height can cause chipping or cracking of the varistors because of mechanical impact on the varistors. To avoid this, the monitoring of the width between the alignment pin in the stopped position, and maintenance, inspection and replacement of the pin should be conducted periodically.</p>		Not recommended	Recommended	Single-sided mounting			Double-sided mounting		
	Not recommended	Recommended									
Single-sided mounting											
Double-sided mounting											

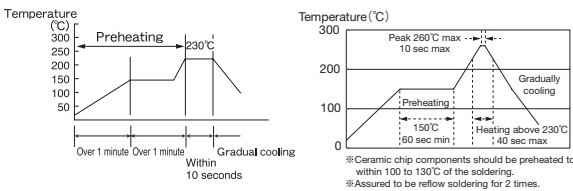
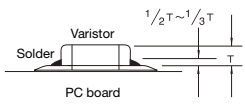

Precautions on the use of Multilayer chip varistors.

Stages	Precautions	Technical considerations
<p>3.Considerations for automatic placement</p>	<p><b>Selection of Adhesives</b></p> <p>1.Mounting varistors with adhesives in preliminary assembly, before the soldering stage, may lead to degraded varistor characteristics unless the following factors are appropriately checked; the size of land patterns, type of adhesive, amount applied, hardening temperature and hardening period. Therefore, it is imperative to consult the manufacturer of the adhesives on proper usage and amounts of adhesive to use.</p>	<p>1.Some adhesives may cause reduced insulation resistance. The difference between the shrinkage percentage of the adhesive and that of the varistors may result in stresses on the varistors and lead to cracking. Moreover, too little or too much adhesive applied to the board may adversely affect component placement, so the following precautions should be noted in the application of adhesives.</p> <p>(1)Required adhesive characteristics</p> <ul style="list-style-type: none"> <li>a. The adhesive should be strong enough to hold parts on the board during the mounting &amp; solder process.</li> <li>b. The adhesive should have sufficient strength at high temperatures.</li> <li>c. The adhesive should have good coating and thickness consistency.</li> <li>d. The adhesive should be used during its prescribed shelf life.</li> <li>e. The adhesive should harden rapidly.</li> <li>f. The adhesive must not be contaminated.</li> <li>g. The adhesive should have excellent insulation characteristics.</li> <li>h. The adhesive should not be toxic and have no emission of toxic gasses.</li> </ul> <p>(2)When using adhesives to mount varistors on a PCB, inappropriate amounts of adhesive on the board may adversely affect component placement. Too little adhesive may cause the varistors to fall off the board during the solder process. Too much adhesive may cause defective soldering due excessive flow of adhesive on to the land or solder pad.</p>
<p>4.Soldering</p>	<p><b>Selection of Flux</b></p> <p>1.Since flux may have a significant effect on the performance of varistors, it is necessary to verify the following conditions prior to use;</p> <ul style="list-style-type: none"> <li>(1)Flux used should be with less than or equal to 0.1 wt% (equivalent to chlorine)of halogenated content. Flux having a strong acidity content should not be applied.</li> <li>(2)When soldering varistors on the board, the amount of flux applied should be controlled at the optimum level.</li> <li>(3)When using water-soluble flux, special care should be taken to properly clean the boards.</li> </ul> <p><b>Soldering</b></p> <p>Temperature, time, amount of solder, etc. are specified in accordance with the following recommended conditions.</p>	<p>1-1.When too much halogenated substance (Chlorine, etc.) content is used to activate the flux, or highly acidic flux is used, an excessive amount of residue after soldering may lead to corrosion of the terminal electrodes or degradation of insulation resistance on the surface of the varistors.</p> <p>1-2.Since the residue of water-soluble flux is easily dissolved by water content in the air, the residue on the surface of varistors in high humidity conditions may cause a degradation of insulation resistance and therefore affect the reliability of the components. The cleaning methods and the capability of the machines used should also be considered carefully when selecting water-soluble flux.</p> <p>1-1. Preheating when soldering</p> <p>Heating: Ceramic chip components should be preheated to within 100 to 130°C of the soldering.</p> <p>Cooling: The temperature difference between the components and cleaning process should not be greater than 100°C.</p> <p>Ceramic chip varistors are susceptible to thermal shock when exposed to rapid or concentrated heating or rapid cooling. Therefore, the soldering process must be conducted with great care so as to prevent malfunction of the components due to excessive thermal shock.</p> <p><b>Recommended conditions for soldering</b></p> <p>[Reflow soldering]</p> <p>Temperature profile</p>  <p><b>Caution</b></p> <p>1.The ideal condition is to have solder mass (fillet) controlled to 1/2 to 1/3 of the thickness of the varistor, as shown below:</p>  <p>2.Because excessive dwell times can detrimentally affect solder ability, soldering duration should be kept as close to recommended times as possible.</p>

Precautions on the use of Multilayer chip varistors.

Stages	Precautions	Technical considerations
5.Cleaning	<p>Cleaning conditions</p> <p>1.When cleaning the PC board after the varistors are all mounted, select the appropriate cleaning solution according to the type of flux used and purpose of the cleaning (e.g. to remove soldering flux or other materials from the production process.)</p> <p>2.Cleaning conditions should be determined after verifying, through a test run, that the cleaning process does not affect the varistor's characteristics.</p>	<p>1.The use of inappropriate solutions can cause foreign substances such as flux residue to adhere to the varistor or deteriorate the varistor's outer coating, resulting in a degradation of the varistor's electrical properties (especially insulation resistance).</p> <p>2.Inappropriate cleaning conditions (insufficient or excessive cleaning) may detrimentally affect the performance of the varistors.</p> <p>(1)Excessive cleaning</p> <p>In the case of ultrasonic cleaning, too much power output can cause excessive vibration of the PC board which may lead to the cracking of the varistor or the soldered portion, or decrease the terminal electrodes' strength. Thus the following conditions should be carefully checked;</p> <p>Ultrasonic output           Below 20 W/ℓ</p> <p>Ultrasonic frequency       Below 40 kHz</p> <p>Ultrasonic washing period  5 min. or less</p>
6.Post cleaning processes	<p>1.With some type of resins a decomposition gas or chemical reaction vapor may remain inside the resin during the hardening period or while left under normal storage conditions resulting in the deterioration of the varistor's performance.</p> <p>2 When a resin's hardening temperature is higher than the varistor's operating temperature, the stresses generated by the excess heat may lead to varistor damage or destruction. The use of such resins, molding materials etc. is not recommended.</p>	
7.Handling	<p>Breakaway PC boards (splitting along perforations)</p> <p>1. When splitting the PC board after mounting varistors and other components, care is required so as not to give any stresses of deflection or twisting to the board.</p> <p>2.Board separation should not be done manually, but by using the appropriate devices.</p> <p>Mechanical considerations</p> <p>1.Be careful not to subject the varistors to excessive mechanical shocks.</p> <p>(1)If ceramic varistors are dropped onto the floor or a hard surface, they should not be used.</p> <p>(2)When handling the mounted boards, be careful that the mounted components do not come in contact with or bump against other boards or components.</p>	
8.Storage conditions	<p>Storage</p> <p>1.To maintain the solder ability of terminal electrodes and to keep the packaging material in good condition, care must be taken to control temperature and humidity in the storage area. Humidity should especially be kept as low as possible.</p> <p>•Recommended conditions</p> <p style="padding-left: 20px;">Ambient temperature Below 40°C</p> <p style="padding-left: 20px;">Humidity Below 70% RH</p> <p>The ambient temperature must be kept below 30C. Even under ideal storage conditions varistor electrode solder ability decreases as time passes, so should be used within 6 months from the time of delivery.</p> <p>•Ceramic chip varistors should be kept where no chlorine or sulfur exists in the air.</p>	<p>1.If the parts are stored in a high temperature and humidity environment, problems such as reduced solder ability caused by oxidation of terminal electrodes and deterioration of taping/package materials may take place. For this reason, components should be used within 6 months from the time of delivery. If exceeding the above period, please check solder ability before using the varistors.</p>