

This drawing involves proprietary design rights of Tyco Electronics Corporation, and all design, manufacture, reproduction, use and sale rights regarding the same are expressly reserved. It is submitted for a specific purpose and the recipient by accepting this drawing, assumes custody and control and agrees to take reasonable precautions: (a) that this drawing will not be copied and reproduced, in whole or in part, or its contents revealed in any manner, or to any person except to meet the purpose for which it was delivered and (b) that any special features peculiar to this design will not be incorporated in other projects without the expressed written permission of Tyco Electronics Corporation.

REVISIONS			
EC	REV	DESCRIPTION	DATE
CPR	A	NEW RELEASE	3/22/06

- 7. CONTACTS PURCHASED SEPARATELY.
- 6. ELCON EQUIVALENT SERIES 296-0040-01100.
- 5. ITEMS PROVIDED TO THIS SPECIFICATION TO BE PERMANENTLY IDENTIFIED PER THE FOLLOWING IDENTIFIER:

YEAR WEEK

TYCO PART NUMBER DATE CODE (e.g. 0622)

|-----| |-----|

|XXXXXXXX-X| |XXXX|

4. A REFERENCE DIMENSION (X.XX) IS WITHOUT TOLERANCE AND USED FOR INFORMATION ONLY.

3. FINISHES:
RETENTION CLIPS: BRITE DIP PICKLED PER INDUSTRY STANDARDS.



2. MATERIALS:
INSULATORS: THERMOPLASTIC, GLASS REINFORCED,
UL94V-0 FLAMMABILITY RATED, COLOR-BLACK.

RETENTION CLIPS: COPPER OR STAINLESS STEEL.

1. PART NUMBER CHANGES AND OR DESIGN CHANGES AFFECTING ITEM INTERCHANGEABILITY REQUIRE PRIOR TYCO APPROVAL AND AUTHORIZATION BY REVISION TO THIS DRAWING.

NOTES: UNLESS OTHERWISE SPECIFIED

TYCO PART NUMBER
1648574-1

INCH OR INCH (MM)  THIRD ANGLE PROJECTION UNLESS OTHERWISE SPECIFIED DIMENSIONS ARE IN INCHES (METRIC) TOLERANCES ANGLES ± .5' DECIMALS .XXX ± .010 (.25) .XX ± .02 (.3)	DRAWN R. F. A.	DATE 3/22/06	 Tyco Electronics Corporation Menlo Park, Ca 94025 		
	CHECKED		TITLE CONNECTOR, SOCKET WITH RETENTION CLIPS QUAD POWER		
	APPROVED		SIZE B	DWG NUMBER C= 1648574	REV. A
	APPROVED S. FLICKINGER DCA APPROVED		ACAD FILE NUMBER C1648574A.DWG		
DWG SCALE 1=1			SH 1 of 2		

This drawing involves proprietary design rights of Tyco Electronics Corporation, and all design, manufacture, reproduction, use and sale rights regarding the same are expressly reserved. It is submitted for a specific purpose and the recipient by accepting this drawing, assumes custody and control and agrees to take reasonable precautions: (a) that this drawing will not be copied and reproduced in whole or in part, or its contents revealed in any manner, or to any person except to meet the purpose for which it was delivered and (b) that any special features peculiar to this design will not be incorporated in other projects without the expressed written permission of Tyco Electronics Corporation.

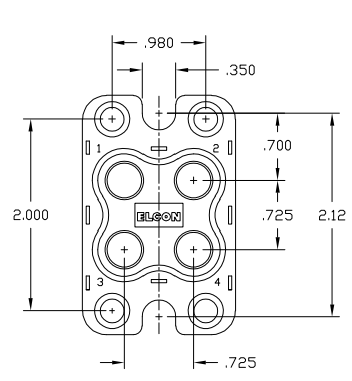

FRONT VIEW

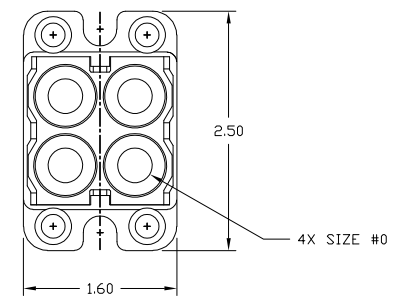
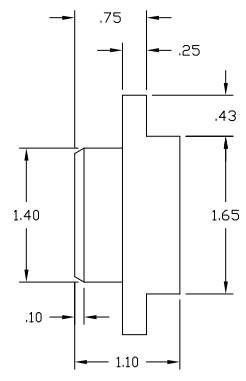

REAR VIEW

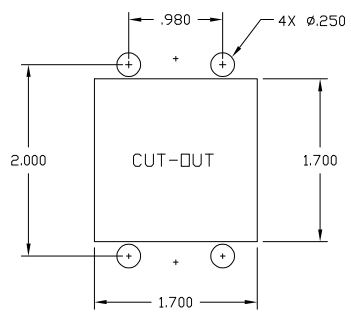

PANEL MOUNT

REVISIONS			
EC	REV	DESCRIPTION	DATE
		SEE SHEET 1	

INCH OR INCH (MM) THIRD ANGLE PROJECTION UNLESS OTHERWISE SPECIFIED DIMENSIONS ARE IN INCHES (METRIC) TOLERANCES ANGLES ± .5° DECIMALS .XXX ± .010 (.25) .XX ± .02 (.3)	DRAWN R. F. A.	DATE 3/22/06	Tyco Electronics Corporation Menlo Park, Ca 94025 	TITLE CONNECTOR, SOCKET WITH RETENTION CLIPS QUAD POWER	SIZE B	DWG NUMBER C= 1648574	REV. A
	CHECKED						
	APPROVED						
	APPROVED S. FLICKINGER DCA APPROVED						
ACAD FILE NUMBER	C1648574A.DWG		DWG SCALE	1=1	SH 2 of 2		