

“ZNR” Transient/Surge Absorbers

Type: **E**



The ZNR Type E is capable of handling larger surge energy than Type D in applications to protect electronic equipment or semiconductor devices from switching and induced lightning surges.

■ Features

- Very large surge withstanding capability with a compact size
- Direct mounting on boards like a power distribution board available
- Fast response to steep impulse voltage
- Low clamping voltage for better surge protection

■ Related Standards

[UL/CSA recognized models are available on request]

- UL1449 File No. E321499
(Title: Surge Protective Devices)
- CSA C22.2 No.1 Class 2221 01 File No. LR-92226
(Title: Accessories and Parts for Electronic Products)
- Each type designation is not registered by Part Number. If you have any question on type designation, please contact and ask our office.

■ Explanation of Part Numbers

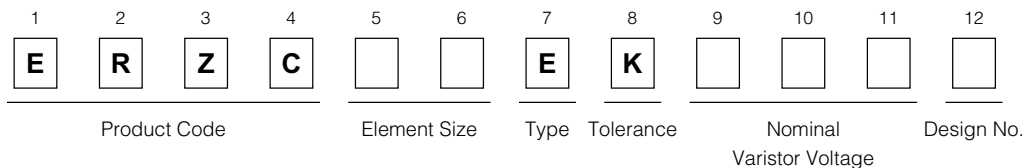

■ Dimensions in mm (not to scale)

Part No.	W	H	L
ERZC20EK□□□□	48±1	42±1	39±1
ERZC32EK□□□□	60±1	55±1	51±1

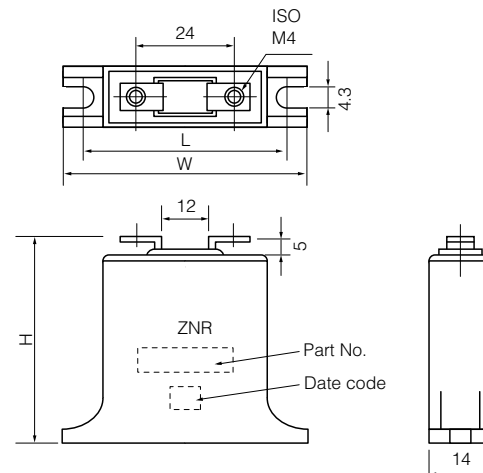

■ Recommended Applications

- Transistor, diode, IC, thyristor or triac semiconductor protection
- Surge protection in industrial power plant operations
- Relay or electromagnetic valve surge absorption
- Surge absorption applications in broadcasting, communications devices, traffic/railroad, agricultural facilities, waterworks
- Surge protection of automatic control devices for power distribution line

■ Handling Precautions

Please see Pages 350 to 352

Note: Ask our factory for Product Specification before use.

■ Minimum Quantity / Packing Unit

Please see Page 360

20 Series

■ Ratings and Characteristics (ERZC20EK)

- Operating Temperature Range : -40 to 85 °C
- Storage Temperature Range : -40 to 110 °C

Part No.	Varistor Voltage	Maximum Allowable Voltage		Maximum Clamping Voltage	Rated Power	Energy (2 ms)	Maximum Peak Current (8/20 μs)		Typical Capacitance (Reference)
		ACrms (V)	DC (V)				1 time (A)	2 times (A)	
	V _{1mA} (V)	ACrms (V)	DC (V)	V _{100A} (V)	(W)	(J)	(A)	(A)	@1kHz (pF)
ERZC20EK201	200 (185 to 225)	130	170	340	0.8	80	8000	5000	2300
ERZC20EK241	240 (216 to 264)	150	200	395	0.8	95	8000	5000	1500
ERZC20EK271	270 (247 to 303)	175	225	455	0.8	100	8000	5000	1400
ERZC20EK361	360 (324 to 396)	230	300	595	0.8	120	8000	5000	1300
ERZC20EK391	390 (351 to 429)	250	320	650	0.8	130	8000	5000	1200
ERZC20EK431	430 (387 to 473)	275	350	710	0.8	140	8000	5000	1000
ERZC20EK471	470 (423 to 517)	300	385	775	0.8	150	8000	5000	950
ERZC20EK511	510 (459 to 561)	320	415	845	0.8	150	8000	5000	930
ERZC20EK621	620 (558 to 682)	385	505	1025	0.8	160	8000	5000	900
ERZC20EK681	680 (612 to 748)	420	560	1120	0.8	175	8000	5000	850
ERZC20EK751	750 (675 to 825)	460	615	1240	0.8	190	8000	5000	800
ERZC20EK781	780 (702 to 858)	485	640	1290	0.8	200	8000	5000	800
ERZC20EK821	820 (738 to 902)	510	670	1355	0.8	215	8000	5000	700
ERZC20EK911	910 (819 to 1001)	550	745	1500	0.8	240	8000	5000	700
ERZC20EK102	1000 (900 to 1100)	625	825	1650	0.8	245	8000	5000	400
ERZC20EK112	1100 (990 to 1210)	680	895	1815	0.8	250	8000	5000	350

32 Series

■ Ratings and Characteristics (ERZC32EK)

- Operating Temperature Range : -40 to 85 °C
- Storage Temperature Range : -40 to 110 °C

Part No.	Varistor Voltage	Maximum Allowable Voltage		Maximum Clamping Voltage	Rated Power	Energy (2 ms)	Maximum Peak Current (8/20 μs)		Typical Capacitance (Reference)
		ACrms (V)	DC (V)				1 time (A)	2 times (A)	
	V _{1mA} (V)	ACrms (V)	DC (V)	V _{200A} (V)	(W)	(J)	(A)	(A)	@1kHz (pF)
ERZC32EK201	200 (185 to 225)	130	170	340	1.2	210	25000	20000	5500
ERZC32EK241	240 (216 to 264)	150	200	395	1.2	240	25000	20000	5000
ERZC32EK271	270 (247 to 303)	175	225	455	1.2	255	25000	20000	4200
ERZC32EK361	360 (324 to 396)	230	300	595	1.2	325	25000	20000	3500
ERZC32EK391	390 (351 to 429)	250	320	650	1.2	350	25000	20000	3000
ERZC32EK431	430 (387 to 473)	275	350	710	1.2	400	25000	20000	2500
ERZC32EK471	470 (423 to 517)	300	385	775	1.2	405	25000	20000	2500
ERZC32EK511	510 (459 to 561)	320	415	845	1.2	405	25000	20000	2400
ERZC32EK621	620 (558 to 682)	385	505	1025	1.2	415	25000	20000	2200
ERZC32EK681	680 (612 to 748)	420	560	1120	1.2	450	25000	20000	2100
ERZC32EK751	750 (675 to 825)	460	615	1240	1.2	500	25000	20000	2000
ERZC32EK781	780 (702 to 858)	485	640	1290	1.2	520	25000	20000	1900
ERZC32EK821	820 (738 to 902)	510	670	1355	1.2	545	25000	20000	1800
ERZC32EK911	910 (819 to 1001)	550	745	1500	1.2	600	25000	20000	1700
ERZC32EK102	1000 (900 to 1100)	625	825	1650	1.2	620	25000	20000	1000
ERZC32EK112	1100 (990 to 1210)	680	895	1815	1.2	640	25000	20000	800

Design and specifications are each subject to change without notice. Ask factory for the current technical specifications before purchase and/or use.
Should a safety concern arise regarding this product, please be sure to contact us immediately.

00 Sep. 2010

■ Typical Characteristics (Type E)
Voltage vs. Current
 (ERZC20EK201 to ERZC20EK511)

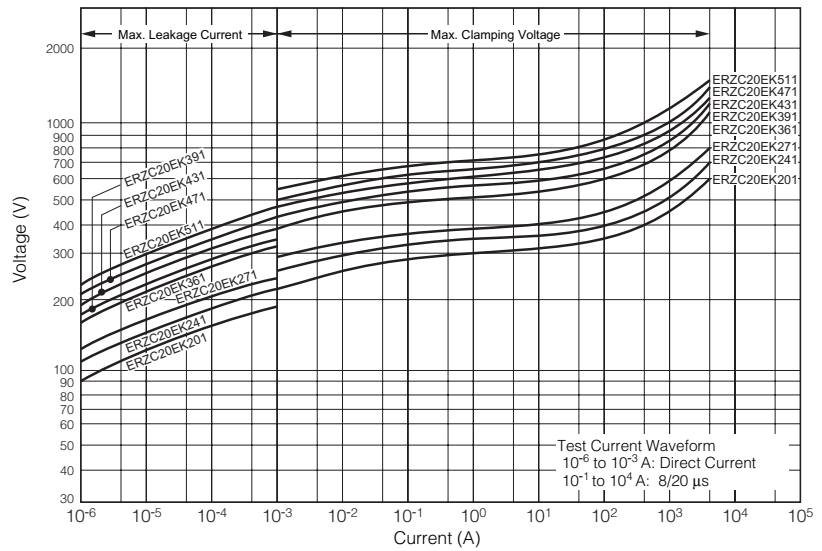

(ERZC20EK621 to ERZC20EK112)

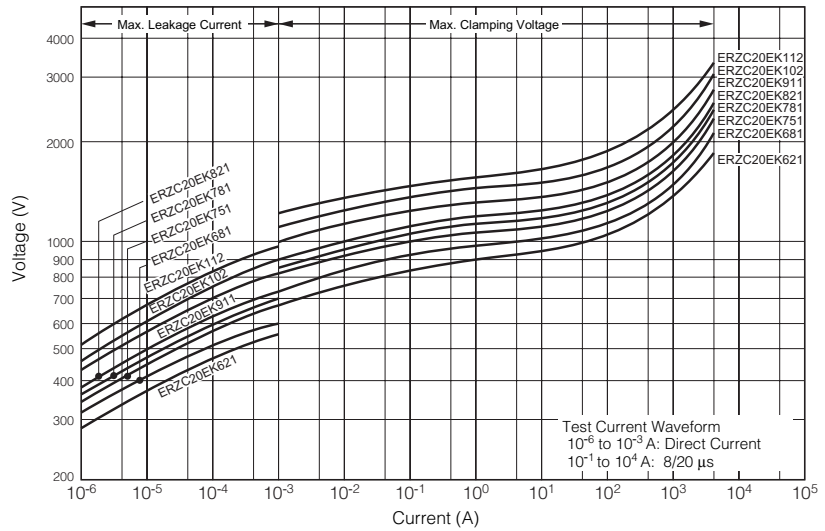

■ Impulse Derating Curve (Relation between impulse width and surge, repetitively)

20 Series
 (ERZC20EK201 to ERZC20EK271)

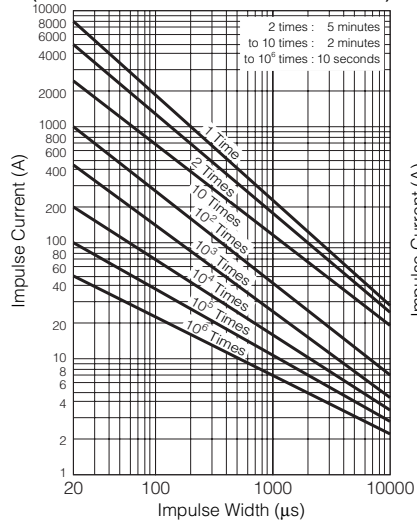

20 Series
 (ERZC20EK361 to ERZC20EK681)

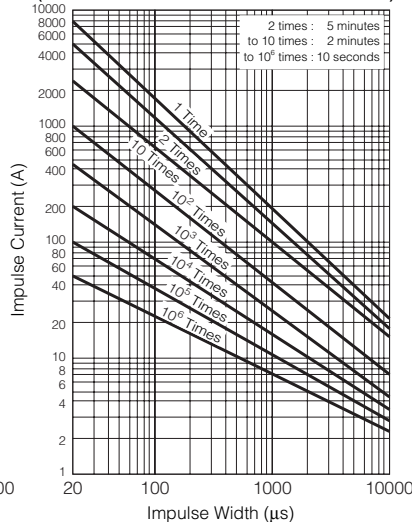

20 Series
 (ERZC20EK751 to ERZC20EK112)

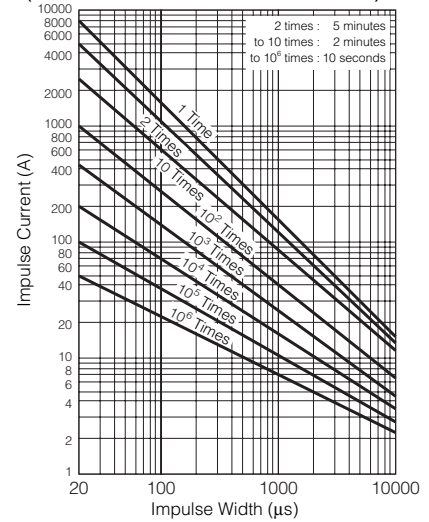

Design and specifications are each subject to change without notice. Ask factory for the current technical specifications before purchase and/or use. Should a safety concern arise regarding this product, please be sure to contact us immediately.

■ Typical Characteristics (Type E)
Voltage vs. Current
 (ERZC32EK201 to ERZC32EK511)

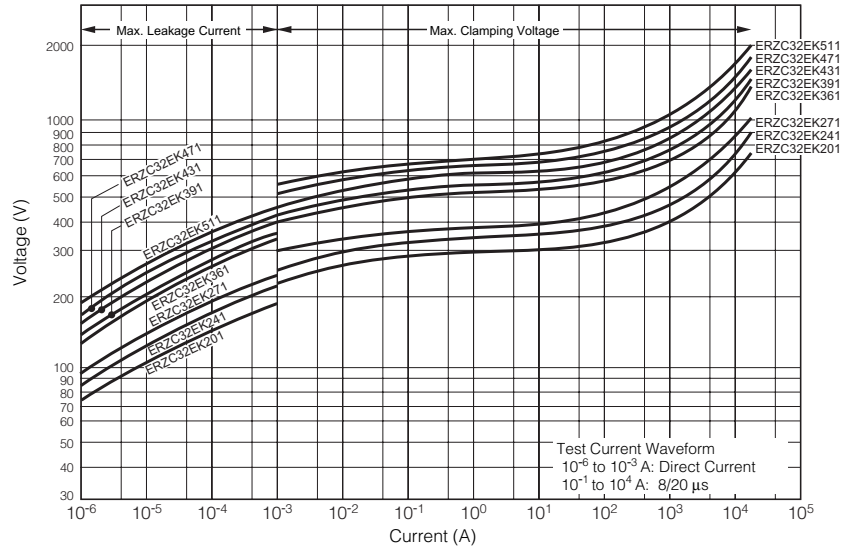

(ERZC32EK621 to ERZC32EK112)

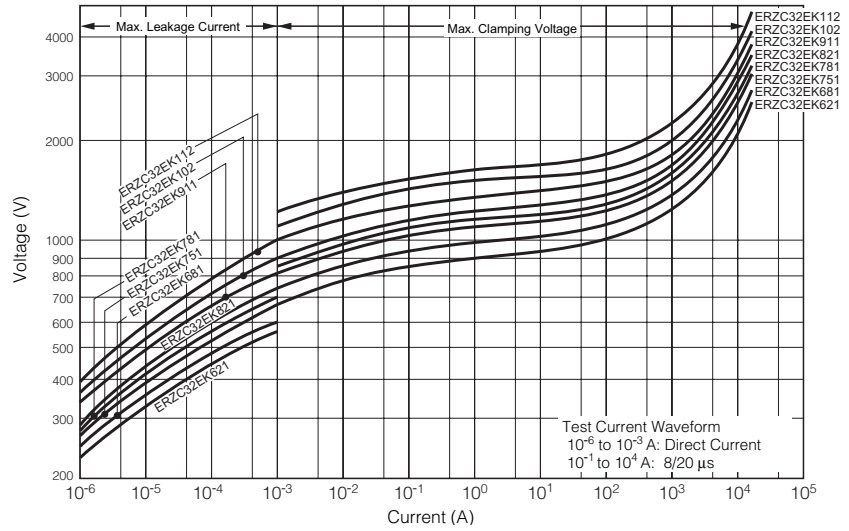

■ Impulse Derating Curve (Relation between impulse width and surge, repetitively)

32 Series

(ERZC32EK201 to ERZC32EK271)

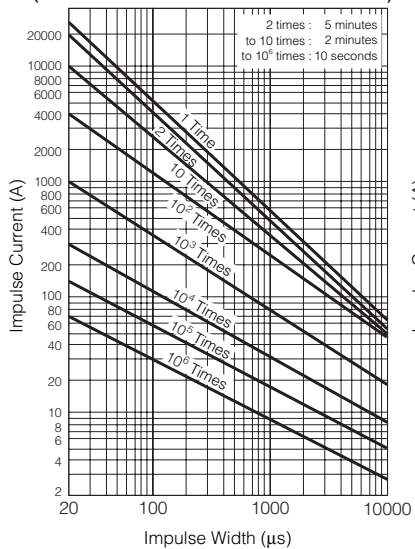

32 Series

(ERZC32EK361 to ERZC32EK681)

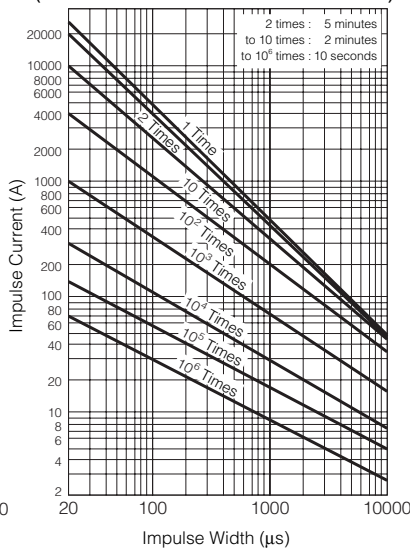

32 Series

(ERZC32EK751 to ERZC32EK112)

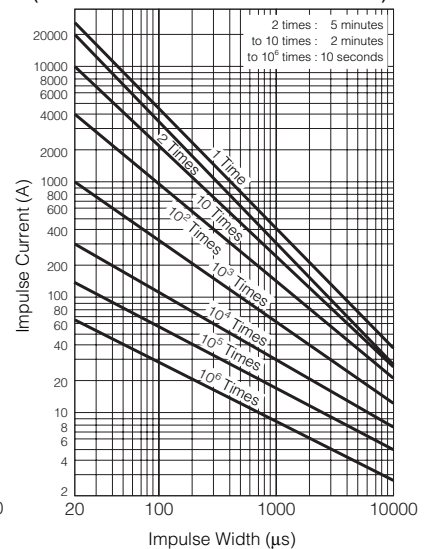

Design and specifications are each subject to change without notice. Ask factory for the current technical specifications before purchase and/or use. Should a safety concern arise regarding this product, please be sure to contact us immediately.

■ Performance Characteristics (Type E)

Characteristics		Test Methods/Description	Specifications															
Standard Test Condition		Electrical characteristics shall be measured at following conditions (Temperature: 5 to 35 °C, Humidity: Max. 85 %)	—															
Electrical	Varistor Voltage	The voltage between two terminals with the specified measuring current I_{mA} DC applied is called V_c or $V_{c mA}$. The measurement shall be made as fast as possible to avoid heat affection.	To meet the specified value.															
	Maximum Allowable Voltage	The maximum sinusoidal wave voltage (rms) or the maximum DC voltage that can be applied continuously.																
	Clamping Voltage	The maximum voltage between two terminals with the specified standard impulse current (8/20 μ s).																
	Rated Power	The maximum power that can be applied within the specified ambient temperature.																
	Energy	The maximum energy within the varistor voltage change of ± 10 % when one impulse of 2 ms is applied.																
	Maximum Peak Current	2 times		The maximum current within the varistor voltage change of ± 10 % with the standard impulse current (8/20 μ s) applied two times with an interval of 5 minutes.														
		1 time		The maximum current within the varistor voltage change of ± 10 % with the standard impulse current (8/20 μ s) applied one time.														
	Temperature Coefficient of Varistor Voltage	$\frac{V_c \text{ at } 70^\circ\text{C} - V_c \text{ at } 20^\circ\text{C}}{V_c \text{ at } 20^\circ\text{C}} \times \frac{1}{50} \times 100 (\%/^\circ\text{C})$		0 to -0.05 %/ $^\circ\text{C}$ max.														
	Impulse Life	The change of V_c shall be measured after the impulse listed below is applied 10000 times continuously with the interval of ten seconds at room temperature. <table border="1" style="margin-left: auto; margin-right: auto;"> <tr> <td>20 Series</td> <td>200 A (8/20 μs)</td> </tr> <tr> <td>32 Series</td> <td>300 A (8/20 μs)</td> </tr> </table>		20 Series	200 A (8/20 μ s)	32 Series	300 A (8/20 μ s)	$\Delta V_{1 \text{ mA}} / V_{1 \text{ mA}} \leq \pm 10$ %										
	20 Series	200 A (8/20 μ s)																
32 Series	300 A (8/20 μ s)																	
Withstanding Voltage (Body Insulation)	The commercial frequency voltage of AC 2.5 kV shall be applied between terminals and the bottom of the unit for one minute.	No remarkable damage																
Mechanical	Robustness of Terminations (Tensile)	After gradually applying the load of 49 N (5 kgf) and keeping the unit fixed for 10 seconds in an axial direction, the terminal shall be visually examined for any damage.	No remarkable damage															
	Vibration	After repeatedly applying a single harmonic vibration (amplitude: 0.75 mm): double amplitude: 1.5 mm with 1 minute vibration frequency cycles (10 Hz to 55 Hz to 10 Hz) to each of three perpendicular directions for 2 hours. Thereafter, the damage of the terminals is visually examined.																
Environmental	Dry Heat/ High Temperature Storage	The specimen shall be subjected to 110 ± 3 °C for 500 hours in a thermostatic bath without load and then stored at room temperature and humidity for one to two hours. Thereafter, the change of V_c shall be measured. <table border="1" style="margin-left: auto; margin-right: auto;"> <thead> <tr> <th>Step</th> <th>Temperature (°C)</th> <th>Period (minutes)</th> </tr> </thead> <tbody> <tr> <td>1</td> <td>$-25 \pm \frac{0}{3}$</td> <td>$30 \pm \frac{0}{3}$</td> </tr> <tr> <td>2</td> <td>Room Temp.</td> <td>3 max.</td> </tr> <tr> <td>3</td> <td>$85 \pm \frac{0}{3}$</td> <td>$30 \pm \frac{0}{3}$</td> </tr> <tr> <td>4</td> <td>Room Temp.</td> <td>3 max.</td> </tr> </tbody> </table>	Step	Temperature (°C)	Period (minutes)	1	$-25 \pm \frac{0}{3}$	$30 \pm \frac{0}{3}$	2	Room Temp.	3 max.	3	$85 \pm \frac{0}{3}$	$30 \pm \frac{0}{3}$	4	Room Temp.	3 max.	$\Delta V_{1 \text{ mA}} / V_{1 \text{ mA}} \leq \pm 5$ %
	Step	Temperature (°C)	Period (minutes)															
	1	$-25 \pm \frac{0}{3}$	$30 \pm \frac{0}{3}$															
	2	Room Temp.	3 max.															
	3	$85 \pm \frac{0}{3}$	$30 \pm \frac{0}{3}$															
4	Room Temp.	3 max.																
Temperature Cycle	The temperature cycle shown below shall be repeated five times and then stored at room temperature and humidity for one to two hours. The change of V_c and mechanical damage shall be examined.	No remarkable damage $\Delta V_{1 \text{ mA}} / V_{1 \text{ mA}} \leq \pm 5$ %																
Dry Heat Load/ High Temperature Load	After being continuously applied the Maximum Allowable Voltage at 85 ± 5 °C for 500 hours, the specimen shall be stored at room temperature and humidity for one to two hours. Thereafter, the change of V_c shall be measured.	$\Delta V_{1 \text{ mA}} / V_{1 \text{ mA}} \leq \pm 10$ %																
Damp Heat/Humidity (Steady State)	The specimen shall be subjected to 40 ± 2 °C, 90 to 95 %RH for 1000 hours without load and then stored at room temperature and humidity for one to two hours. Thereafter, the change of V_c shall be measured.	$\Delta V_{1 \text{ mA}} / V_{1 \text{ mA}} \leq \pm 5$ %																

Design and specifications are each subject to change without notice. Ask factory for the current technical specifications before purchase and/or use. Should a safety concern arise regarding this product, please be sure to contact us immediately.