

2-line IPAD™, ultra low capacitance protection for high speed USB

Features

- Ultra low diode capacitance (1.2 pF max)
- Two data lines (D+ and D-) protected against 15 kV ESD
- Breakdown voltage $V_{BR} = 6.0 \text{ V min}$
- Flip Chip 400 μm pitch, lead-free
- Very low leakage current
- Very small PCB area
- RoHS compliant

Benefits

- Minimized impact on rise and fall times for maximum data integrity
- Low PCB space occupation
- Higher reliability offered by monolithic integration

Complies with the following standards

- IEC 61000-4-2 level 4 on external pins:
 - 15 kV (air discharge)
 - 8 kV (contact discharge)
- MIL STD 883G - Method 3015.7
 - 25 kV (Human body model)

Application

- High speed USB port in wireless handsets (up to 480 Mb/s according to USB 2.0 high speed specification)

Description

The USBULC6-2F3 is a monolithic, application specific discrete device dedicated to ESD protection of high speed interfaces.

Its ultra low line capacitance secures a high level of signal integrity without compromising the protection of downstream sensitive chips against the most stringently characterized ESD strikes.

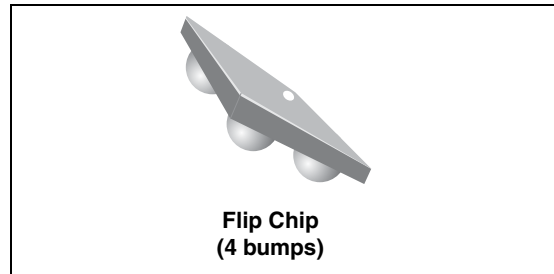

Figure 1. Pin layout (bump side)

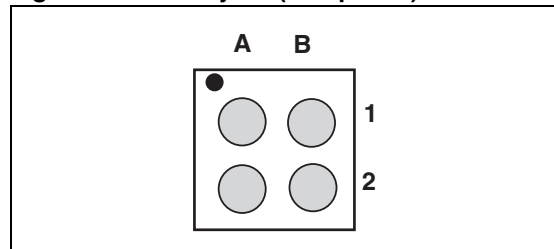
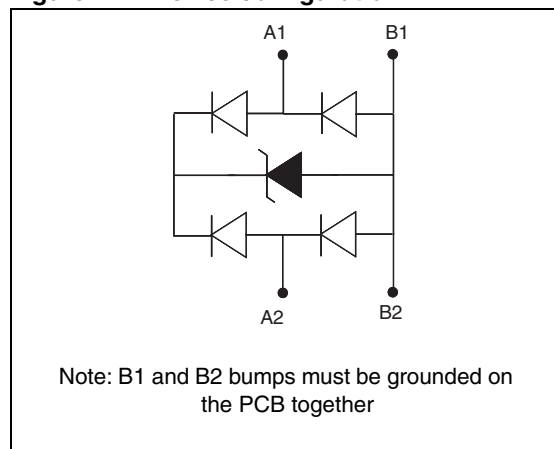

Figure 2. Device configuration



TM: IPAD is a trademark of STMicroelectronics.

1 Characteristics

Table 1. Absolute maximum ratings ($T_{amb} = 25\text{ }^{\circ}\text{C}$)

Symbol	Parameter	Value	Unit
V_{PP}	ESD discharge IEC 61000-4-2, air discharge	15	kV
	ESD discharge IEC 61000-4-2, contact discharge	8	
P_{PP}	Peak pulse power dissipation (8/20 μs)	60	W
T_j	Maximum junction temperature	125	$^{\circ}\text{C}$
T_{op}	Operating temperature range	-30 to +85	$^{\circ}\text{C}$
T_{stg}	Storage temperature range	-55 to +150	$^{\circ}\text{C}$

Table 2. Electrical characteristics ($T_{amb} = 25\text{ }^{\circ}\text{C}$)

Symbol	Parameter				
V_{BR}	Breakdown voltage				
I_{RM}	Leakage current @ V_{RM}				
V_{RM}	Stand-off voltage				
V_{CL}	Clamping voltage				
R_d	Dynamic impedance				
I_{PP}	Peak pulse current				
αT	Voltage temperature coefficient				
V_F	Forward voltage drop				
V_F	Forward voltage drop				
Symbol	Test conditions	Min.	Typ.	Max.	Unit
V_{BR}	$I_R = 1\text{ mA}$	6		9	V
I_{RM}	$V_{RM} = 3\text{ V}$			100	nA
R_d	Exponential wave form 8/20 μs , $I_{pp} = 1\text{ to }5\text{ A}$		1.6		Ω
αT	$I_R = 1\text{ mA}$			5	$10^{-4}/^{\circ}\text{C}$
C_{line}	$V_{LINE} = 0\text{ V}$, $V_{OSC} = 30\text{ mV}$, $F = 1\text{ MHz}$			1.2	pF

Figure 3. Eye diagram, board only (according to USB high speed specification)

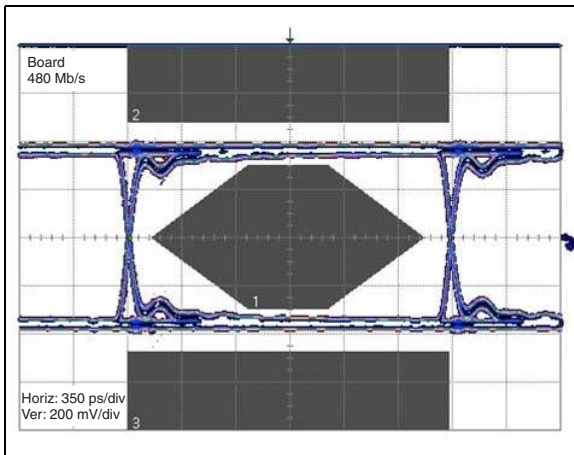

Figure 4. Eye diagram, board with USBULC6-2F3 (according to USB 2.0 high speed specification)

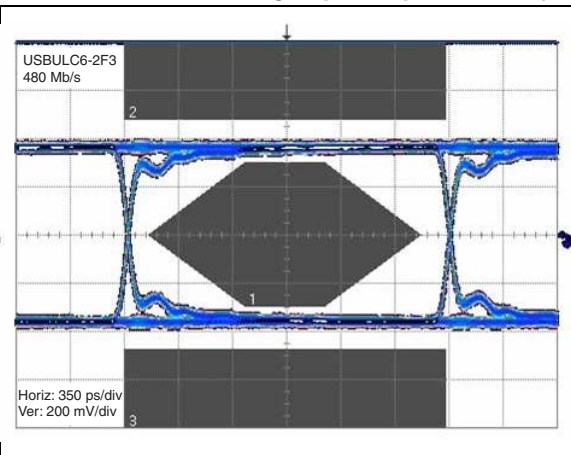

Figure 5. ESD response to IEC 61000-4-2 (+15 kV air discharge)

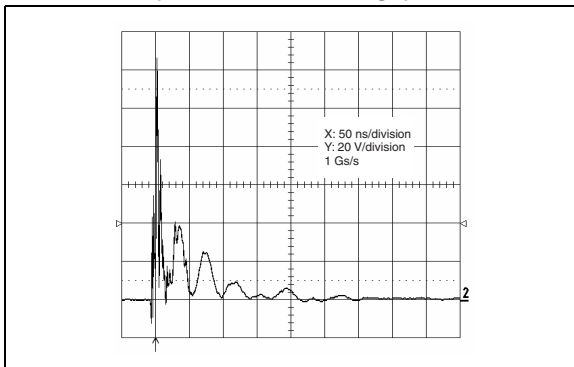

Figure 6. ESD response to IEC 61000-4-2 (-15 kV air discharge)

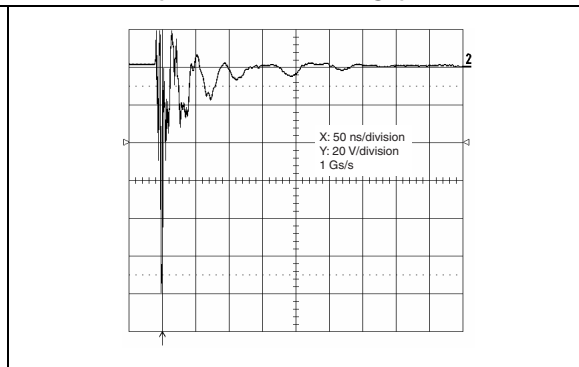

Figure 7. Junction capacitance versus frequency (typical values)

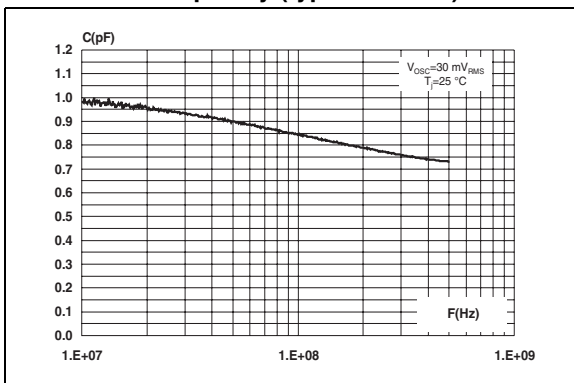

Figure 8. Analog crosstalk measurement

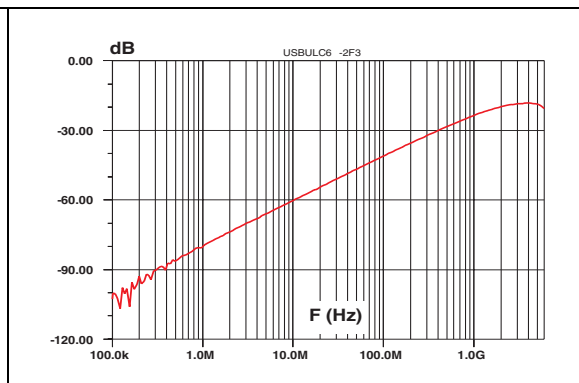

Figure 9. S21 (dB) attenuation measurement

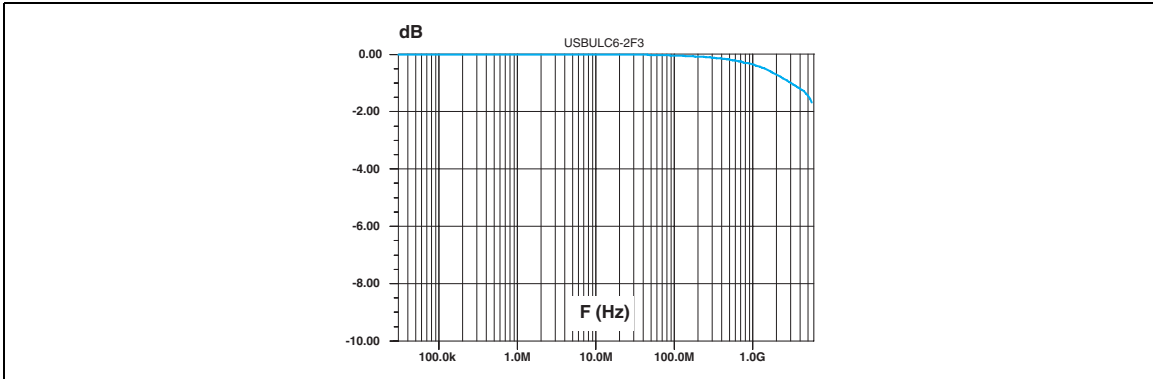

Figure 10. Digital crosstalk

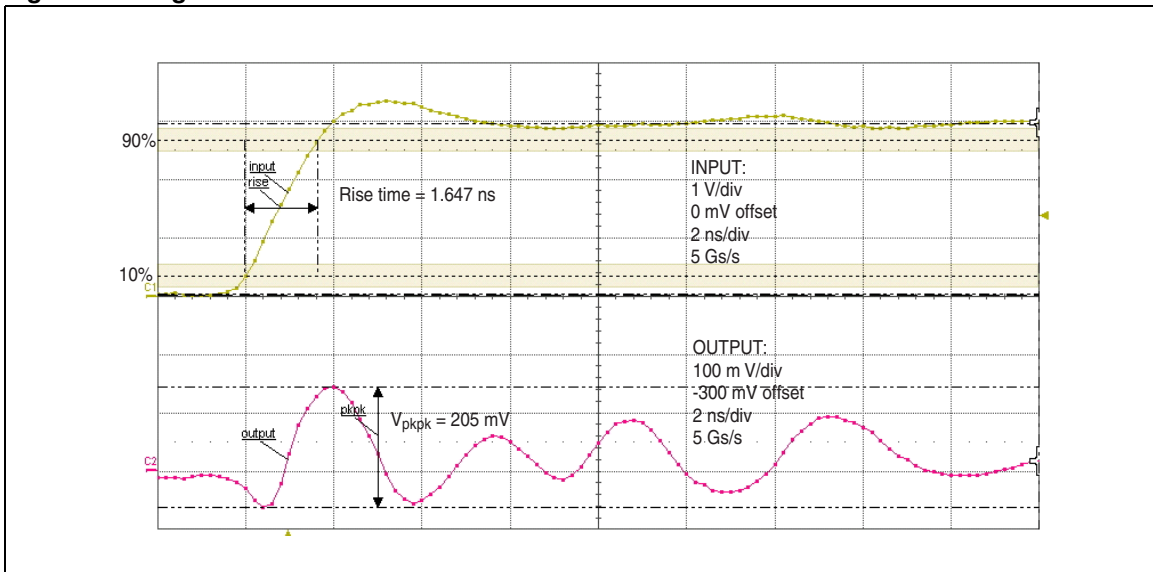

Figure 11. Relative variation of peak pulse power versus initial junction temperature

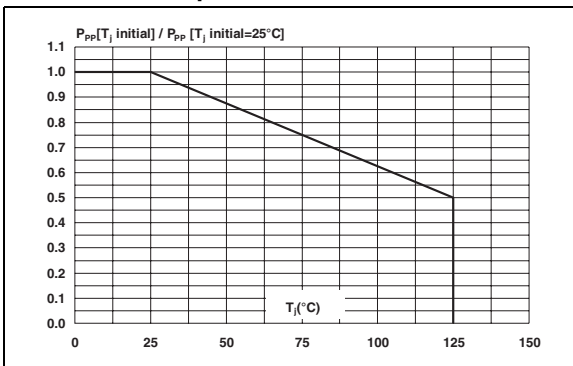

Figure 12. Peak pulse power versus exponential pulse duration

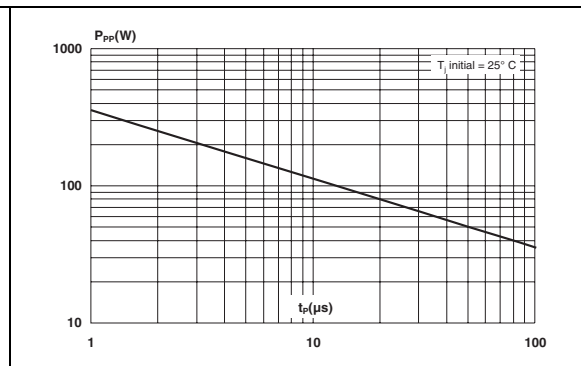

Figure 13. Clamping voltage versus peak pulse current (typical values, exponential waveform)

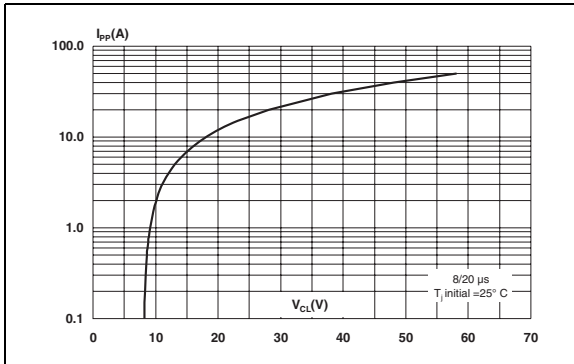
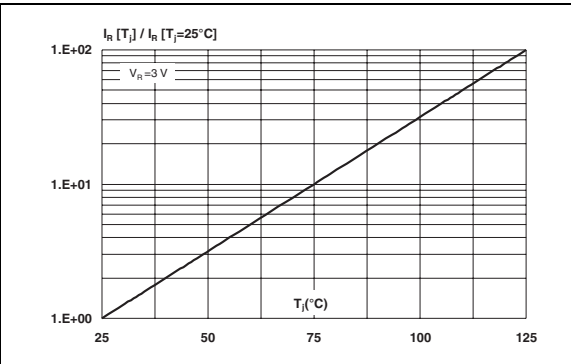
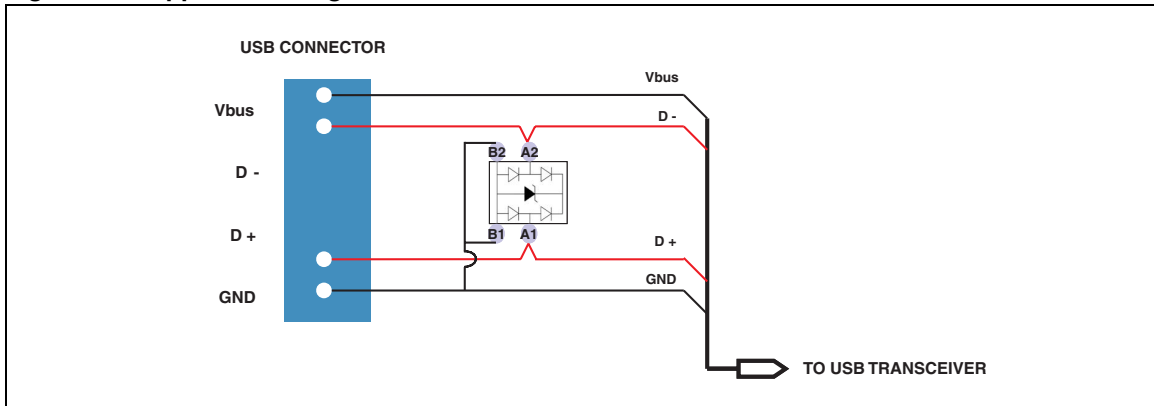

Figure 14. Relative variation of leakage current versus junction temperature (typical values)



2 Application information

Figure 15. Application diagram



3 Ordering information scheme

Figure 16. Ordering information scheme

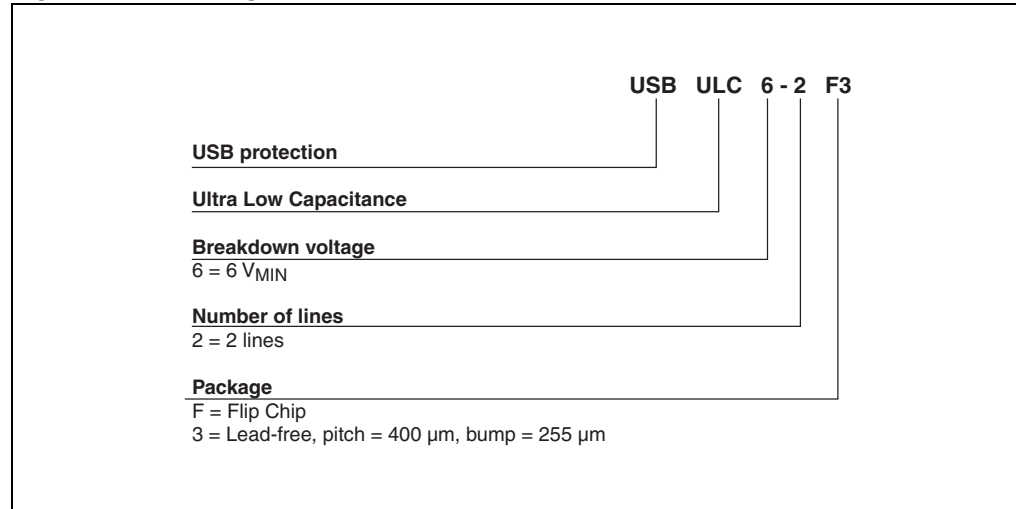

4 Package information

In order to meet environmental requirements, ST offers these devices in ECOPACK[®] packages. These packages have a lead-free second level interconnect. The category of second level interconnect is marked on the inner box label, in compliance with JEDEC Standard JESD97. The maximum ratings related to soldering conditions are also marked on the inner box label. ECOPACK is an ST trademark. ECOPACK specifications are available at www.st.com.

Figure 17. Package dimensions

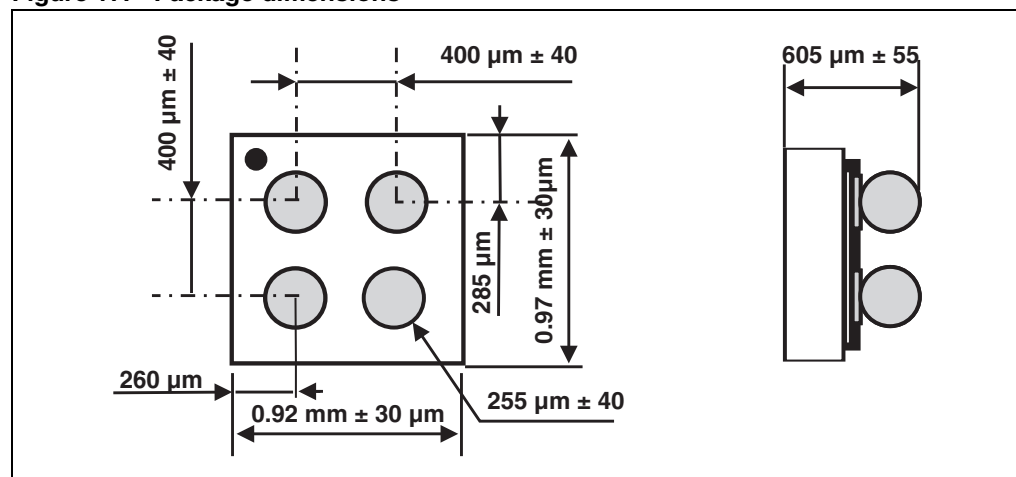

Figure 18. Footprint recommendations Figure 19. Marking

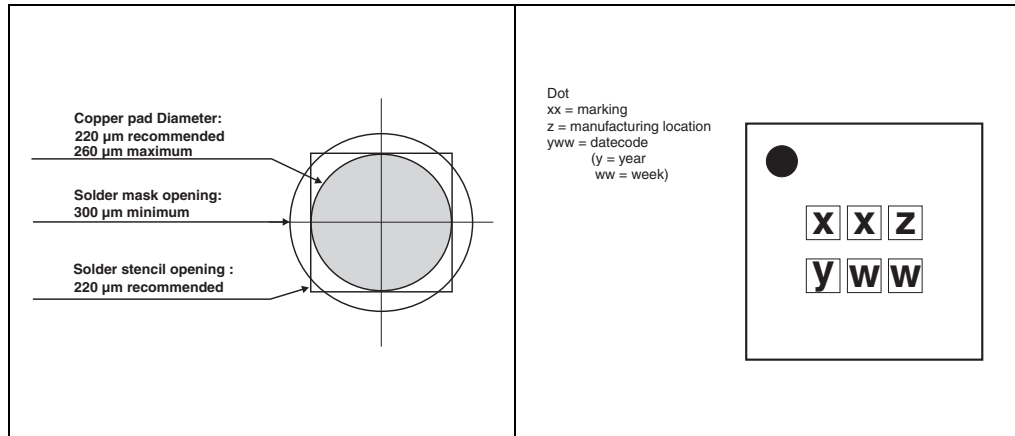
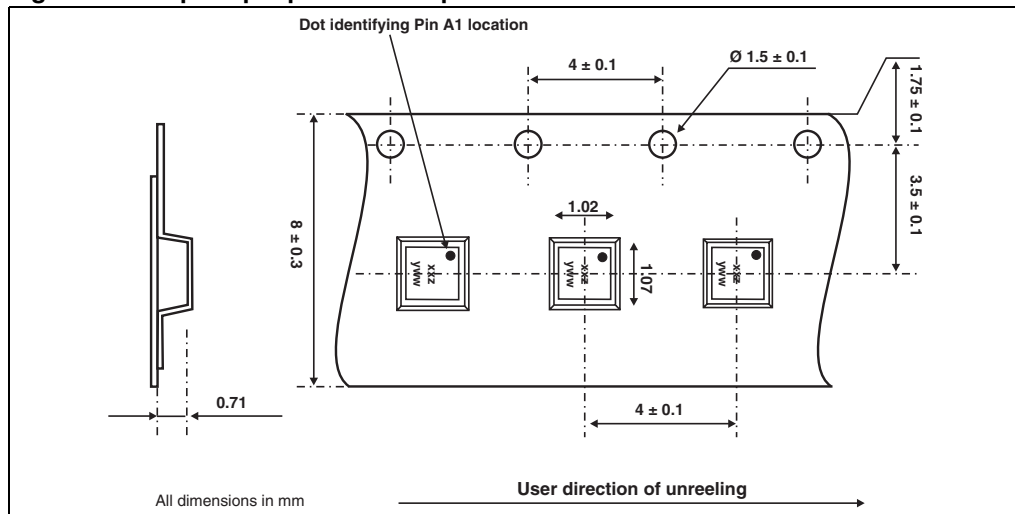

Figure 20. Flip Chip tape and reel specifications



Note: More information is available in the application notes:
 AN2348: "400 µm Flip Chip: Package description and recommendations for use"
 AN1751: "EMI Filters: Recommendations and measurements"

5 Ordering information

Table 3. Ordering information

Order code	Marking	Package	Weight	Base qty	Delivery mode
USBULC6-2F3	EH	Flip Chip	1.16 mg	5000	Tape and reel (7")

6 Revision history

Table 4. Document revision history

Date	Revision	Changes
15-Dec-2006	1	Initial release.
29-Apr-2008	2	Updated ECOPACK statement. Updated Figure 17 , Figure 18 and Figure 20 . Reformatted to current standards.

Please Read Carefully:

Information in this document is provided solely in connection with ST products. STMicroelectronics NV and its subsidiaries ("ST") reserve the right to make changes, corrections, modifications or improvements, to this document, and the products and services described herein at any time, without notice.

All ST products are sold pursuant to ST's terms and conditions of sale.

Purchasers are solely responsible for the choice, selection and use of the ST products and services described herein, and ST assumes no liability whatsoever relating to the choice, selection or use of the ST products and services described herein.

No license, express or implied, by estoppel or otherwise, to any intellectual property rights is granted under this document. If any part of this document refers to any third party products or services it shall not be deemed a license grant by ST for the use of such third party products or services, or any intellectual property contained therein or considered as a warranty covering the use in any manner whatsoever of such third party products or services or any intellectual property contained therein.

UNLESS OTHERWISE SET FORTH IN ST'S TERMS AND CONDITIONS OF SALE ST DISCLAIMS ANY EXPRESS OR IMPLIED WARRANTY WITH RESPECT TO THE USE AND/OR SALE OF ST PRODUCTS INCLUDING WITHOUT LIMITATION IMPLIED WARRANTIES OF MERCHANTABILITY, FITNESS FOR A PARTICULAR PURPOSE (AND THEIR EQUIVALENTS UNDER THE LAWS OF ANY JURISDICTION), OR INFRINGEMENT OF ANY PATENT, COPYRIGHT OR OTHER INTELLECTUAL PROPERTY RIGHT.

UNLESS EXPRESSLY APPROVED IN WRITING BY AN AUTHORIZED ST REPRESENTATIVE, ST PRODUCTS ARE NOT RECOMMENDED, AUTHORIZED OR WARRANTED FOR USE IN MILITARY, AIR CRAFT, SPACE, LIFE SAVING, OR LIFE SUSTAINING APPLICATIONS, NOR IN PRODUCTS OR SYSTEMS WHERE FAILURE OR MALFUNCTION MAY RESULT IN PERSONAL INJURY, DEATH, OR SEVERE PROPERTY OR ENVIRONMENTAL DAMAGE. ST PRODUCTS WHICH ARE NOT SPECIFIED AS "AUTOMOTIVE GRADE" MAY ONLY BE USED IN AUTOMOTIVE APPLICATIONS AT USER'S OWN RISK.

Resale of ST products with provisions different from the statements and/or technical features set forth in this document shall immediately void any warranty granted by ST for the ST product or service described herein and shall not create or extend in any manner whatsoever, any liability of ST.

ST and the ST logo are trademarks or registered trademarks of ST in various countries.

Information in this document supersedes and replaces all information previously supplied.

The ST logo is a registered trademark of STMicroelectronics. All other names are the property of their respective owners.

© 2008 STMicroelectronics - All rights reserved

STMicroelectronics group of companies

Australia - Belgium - Brazil - Canada - China - Czech Republic - Finland - France - Germany - Hong Kong - India - Israel - Italy - Japan - Malaysia - Malta - Morocco - Singapore - Spain - Sweden - Switzerland - United Kingdom - United States of America

www.st.com

