



AIRPAX® | 5003 Series

1/2" BIMETAL DISC THERMOSTAT

FEATURES

- RoHS compliant per EU directive 2002 / 95 / EC
- 1/2" disc button style
- Low profile design
- Ideal for surface and air sensing

DESCRIPTION

The Airpax™ 5003 series is a RoHS compliant, positive snap action, single pole / single throw, bimetallic thermostat which provides accurate and reliable sensing and switching in a single device. The 5003 series is ideal for applications when space is at a premium. Overall depth without projecting terminals is only 0.250 inches.

The basic switch assembly is operated by a bimetal disc with positive, reinforced snap-action, which is known for its reliable repeatability. The construction of the switch assembly offers excellent shock and vibration resistance. Thermal response is fast due to low mass.

The 5003 series offers many terminal and mounting options to fit your application needs. For high humidity and contaminating atmosphere applications, the device is sealed with a non-volatile resin. Narrow differential devices are ideal for control, while standard differentials can be used for high or low temperature limit switches. The series 5003 thermostat is cRUus certified.

SPECIFICATIONS

Contact Ratings	Cycles	Voltage	Amps (resistive)
	100,000	120 VAC	5
	100,000	240 VAC, 24VDC	3
	100,000	48 VDC	1.5
Contact Operations	Either close on rise (make) or open on rise (break), SPST (Single Pole, Single Throw)		
Operating Temperature	+35°F to 325°F (+1.67°C to 162.78°C)		
Temperature Tolerance	Standard of ±5°F with nominal operating temperature settings in 5°F increments		
Long Term Exposure Limit	-40°F to 350°F (-40°C to 176.67°C)		
Dielectric Strength	1500 VRMS 60Hz, 1 minute, terminals to case		
Weight	2.3 grams (0.08 oz)		

* cRUus certified to 168°C operating temperature. Loads under 100mA, 5Vdc, will require gold-plated contacts, with recommended minimum load of 10mA, 5Vdc.

1. CONTACT OPERATION

CODE	DESCRIPTION
O	Letter "O" = Open on Rise
C	Letter "C" = Close on Rise

To build your part number (PN), choose the proper codes from pages 2 to 4.

Consult Sensata Technologies when a code Z is used to indicate a special requirement. Sensata will assign a unique, customer-specific four digit nondescript number. To complete the customer specific part number build, replace the bottom temperature and tolerance (codes 7 & 8) after the "-" dash with the assigned four digit nondescript.

2. TERMINAL SELECTION

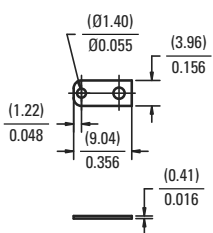
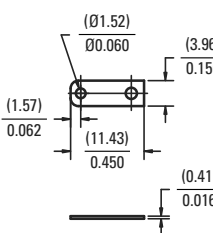
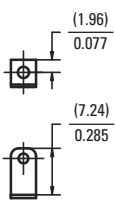
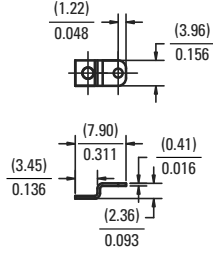
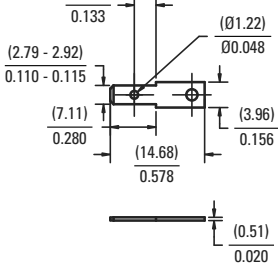
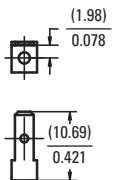
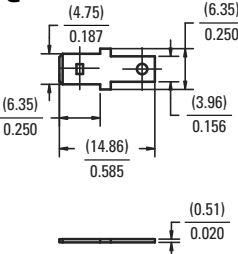
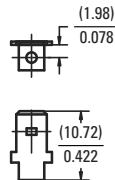
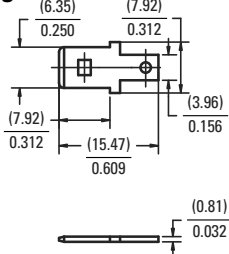
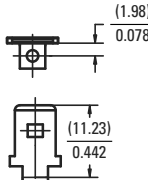
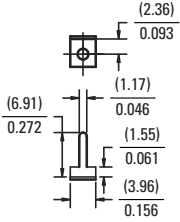
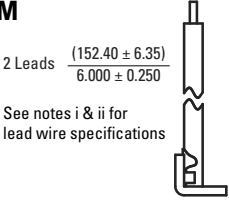
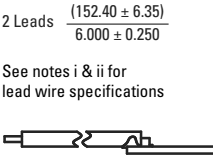
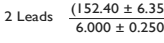
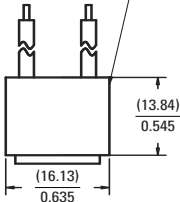
<p>A</p> 	<p>B</p> 	<p>C</p>  <p>Same as View "B" Except Formed 90°</p>	<p>D</p> 	<p>E</p> 
<p>F</p>  <p>Same as View "E" Except Formed 90°</p>	<p>G</p> 	<p>H</p>  <p>Same as View "G" Except Formed 90°</p>	<p>J</p> 	<p>K</p>  <p>Same as View "J" Except Formed 90°</p>
<p>L</p> 	<p>M</p>  <p>See notes i & ii for lead wire specifications</p>	<p>R</p>  <p>See notes i & ii for lead wire specifications</p>	<p>U</p>  <p>See notes i & ii for lead wire specifications</p>	<p>V</p> <p>Same as terminal selection "U"</p> <p>Except 2 Leads (304.80 ± 12.70) / 12.000 ± 0.500</p> <p>See notes i & ii for lead wire specifications</p>
<p>NOTES :</p> <p>The standard lead wire materials for different temperature ranges are as follows :</p> <p>i. Up to 220°F (104.4°C): #18 stranded UL 1015 AWN and CSA TEW approved, black PVC insulation</p> <p>ii. 221°F to 350°F (105°C to 176.6°C): #18 stranded black 'type I' TFE, Teflon® insulation per MIL-W-22759</p>	<p>N</p> <p>Same as terminal selection "M"</p> <p>Except 2 Leads (304.80 ± 12.70) / 12.000 ± 0.500</p> <p>See notes i & ii for lead wire specifications</p>	<p>S</p> <p>Same as terminal selection "R"</p> <p>Except 2 Leads (304.80 ± 12.70) / 12.000 ± 0.500</p> <p>See notes i & ii for lead wire specifications</p>	<p>White Sleeve Potted (Sealed)</p> 	<p>W</p> <p>Same as terminal selection "U"</p> <p>Except 2 Leads (609.60 ± 19.05) / 24.000 ± 0.750</p> <p>See notes i & ii for lead wire specifications</p>
	<p>P</p> <p>Same as terminal selection "M"</p> <p>Except 2 Leads (609.60 ± 19.05) / 24.000 ± 0.750</p> <p>See notes i & ii for lead wire specifications</p>	<p>T</p> <p>Same as terminal selection "R"</p> <p>Except 2 Leads (609.60 ± 19.05) / 24.000 ± 0.750</p> <p>See notes i & ii for lead wire specifications</p>		<p>Z</p> <p>Special Requirements Customer to Specify</p>

EXAMPLE : C53GAB105A-090Y

Close contacts on temperature rise, 5003 series, 0.25" horizontal quick-connects with opposed orientation, 0.140" two hole mounting bracket, 105°F top temperature with a ±5°F standard top tolerance and a standard 15°F differential between top and bottom temperature for temperature range of 35°F to 200°F, differential helps calculate a bottom temperature of 90°F with a standard minimum reset for contacts to open at or above the bottom temperature setpoint.

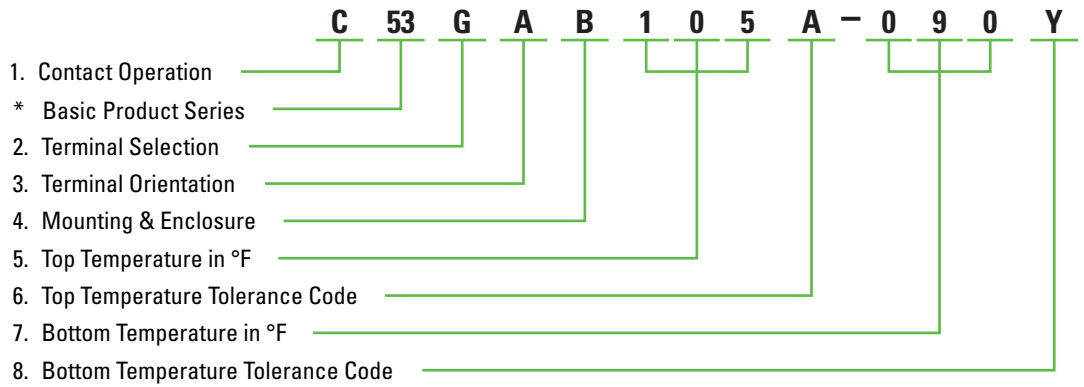

3. TERMINAL ORIENTATION

<p>A</p> <p>OPPOSED - Terminals on opposite sides of thermostat, on a parallel plane to the mounting bracket / base</p>	<p>B</p> <p>PARALLEL - Terminals on same side of thermostat, on a parallel plane to the mounting bracket / base</p>	<p>C</p> <p>VERTICAL - Both terminals extend up and away, on a perpendicular plane to the mounting bracket / base</p>	<p>Z</p> <p>Special Requirements Customer to Specify</p>	<p>NOTES :</p> <p>Terminal orientation restrictions :</p> <p>'A' (Opposed) = A, B, E, G, J, R to T, Z</p> <p>'B' (Parallel) = A, B, E, R to T, Z</p> <p>'C' (Vertical) = C, D, F, H, K to P, U to Z</p>
--	--	--	---	--

4. MOUNTING AND ENCLOSURE SELECTION

<p>A</p>	<p>B</p> <p>2 Mounting Slots</p>	<p>C</p>	<p>D</p>	<p>E</p>
<p>F</p>	<p>G</p>	<p>H</p> <p>6-32 UNC-2A Thread</p> <p>Undercut to Allow Stud to Screw Down Flat</p>	<p>J</p> <p>8-32 UNC-2A Thread</p> <p>Undercut to Allow Stud to Screw Down Flat</p>	<p>Z</p> <p>Special Requirements Customer to Specify</p>

5. TOP TEMPERATURE IN °F

	°F	°C	°F	°C	°F	°C
Temperature Setting	35°F to 200°F	1.6°C to 93°C	201°F to 300°F	94°C to 149°C	301°F to 325°F	150°C to 163°C
Standard Tolerance	±5°F	±2.8°C	±8°F	±4.4°C	±10°F	±5.6°C
Nominal Differential	15°F	8.3°C	25°F	13.8°C	30°F	16.7°C

NOTES:

- Select any temperature in the range of 35°F to 325°F. Standard choices fall on the 5°F increments, for example 35°F, 40°F, 45°F, 50°F... up to 320°F or 325°F
- Specify the °F temperature in the part numbering scheme as a three digit code without the "°F" in the part number. For example, for 90°F, put in code '090'

6. TOP TEMPERATURE TOLERANCE

CODE	A	B	C	X	Z
± °F	±5°F	±8°F	±10°F	Maximum	Customer to Specify
± °C	±2.8°C	±4.4°C	±5.6°C	Maximum	Customer to Specify

NOTES:

- The standard tolerance for the top temperature is based on the temperature range the top temperature falls in, please refer to "5. Top Temperature in °F" chart, and select the appropriate code for a standard top temperature tolerance.

7. BOTTOM TEMPERATURE IN °F

"Bottom Temperature in °F" equals the "Top Temperature in °F" minus the "Nominal Differential in °F for that temperature".

Example 1: 50°F – 15°F = 35°F

Example 2: 250°F – 25°F = 225°F

Example 3: 310°F – 30°F = 280°F

NOTES:

- Specify the °F temperature in the part numbering scheme as a three digit code without the "°F" in the part number (example 90°F, put in the code as '090')

8. BOTTOM TEMPERATURE TOLERANCE

CODE	A	B	C	Y	Z
± °F	±5°F	±8°F	±10°F	Minimum	Customer to Specify
± °C	±2.8°C	±4.4°C	±5.6°C	Minimum	Customer to Specify

NOTES:

- The typical standard bottom temperature tolerance is a 'Y' = minimum trip, which indicates the "reset" trip occurs at or above the lower temperature set point.
- The other standard tolerances are based on the temperature range the bottom temperature is in. The most convenient solution is to use either the 'Y' minimum reset code or choose the same tolerance code selection used in "6. Top Temperature Tolerance Code".



SENSATA TECHNOLOGIES

529 Pleasant Street
 Attleboro, MA 02703-0964 USA
 1-508-236-3287 (Main)
 1-508-236-1598 (Fax)
<http://airpax.sensata.com>
<http://www.sensata.com>

Important Notice: Sensata Technologies (Sensata) reserves the right to make changes to or discontinue any product or service identified in this publication without notice. Sensata advises its customers to obtain the latest version of the relevant information to verify, before placing any orders, that the information being relied upon is current. Sensata assumes no responsibility for infringement of patents or rights of others based on Sensata applications assistance or product specifications since Sensata does not possess full access concerning the use or application of customers' products. Sensata also assumes no responsibility for customers' product designs.