

FK3 MAXI™ Style Blade Fuse Rated 32V

RoHS

The FK3 32V automotive standard fuse link in MAXI size. Three part construction with copper contacts for excellent reliability in harsh environment conditions with low voltage drop. Current ratings 20A thru 100A. With see-through cover for easy detection of blown fuses.

Die FK1 32V-Standsicherung in MAXI-Bauform. Merkmale sind dreiteiliger Aufbau mit Kupferkontakten, niedriger Spannungsabfall und hohe Zuverlässigkeit unter rauen Umgebungsbedingungen. Nennstrom 20A bis 100A, transparente Abdeckung zur leichten Erkennung durchgebrannter Sicherungen.

Specifications

DIN 72581-3E
 SAE J 1888
 ISO 8820-3
 UL 248 Special Purpose Fuses

Insulating body: Out of thermoplastic (UL 94-V0, heat-resistant)
Cover: Out of thermoplastic (UL 94-V0, heat-resistant)
 Visible melting-element
Terminals: Blade contacts
 Copper alloy, gal. Sn
 Edge-protected
Interrupting Rating: 1000 A @32 VDC











Packaging:

Series Serien	Pack Size
169.6885.xxx1	10
169.6885.xxx2	1000

Standard DIN voltage drop from 80A: 100mV

Time-Current Characteristics / Schmelzeit-Grenzwerte

% of Rating % des Nennstromes	Opening Time Min / Max (s) Schmelzcharakteristik Min / Max (s)
135	60 s / 1,800 s
200	2 s / 60 s
350	0.20 s / 7 s
600	0.040 s / 1 s

Part Number Artikel-Nr.	Current Rating Nennstrom	Housing Color Kennfarbe	Typ. Voltage Drop Typ. Spannungsfall		Cold Resistance Kaltwiderstand	I ² t
			Standard DIN max.	Littelfuse max.		
169.6885.520_	20 A		125 mV	95 mV	3.80 mΩ	1,900 A ² s
169.6885.525_	25 A*		–	100 mV	2.80 mΩ	2,300 A ² s
169.6885.530_	30 A		100 mV	80 mV	2.10 mΩ	6,000 A ² s
169.6885.535_	35 A*		–	100 mV	1.70 mΩ	8,400 A ² s
169.6885.540_	40 A		100 mV	85 mV	1.60 mΩ	12,000 A ² s
169.6885.550_	50 A		100 mV	80 mV	1.20 mΩ	26,000 A ² s
169.6885.560_	60 A		100 mV	85 mV	0.90 mΩ	45,000 A ² s
169.6885.570_	70 A		100 mV	90 mV	0.80 mΩ	70,000 A ² s
169.6885.580_	80 A		–	75 mV	0.72 mΩ	94,000 A ² s
169.6885.610_	100 A*		–	95 mV	0.50 mΩ	140,000 A ² s

* Not mentioned in the standards
 Corresponding holder see Section "Fuse Holders."

FK3 MAXI™ Style Blade Fuse Rated 32V

Dimensions in mm / Maße in mm

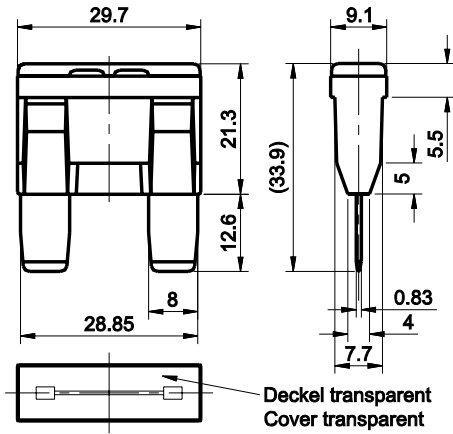

Pre-arcing Time - limits / Schmelzeit-Grenzwerte DIN

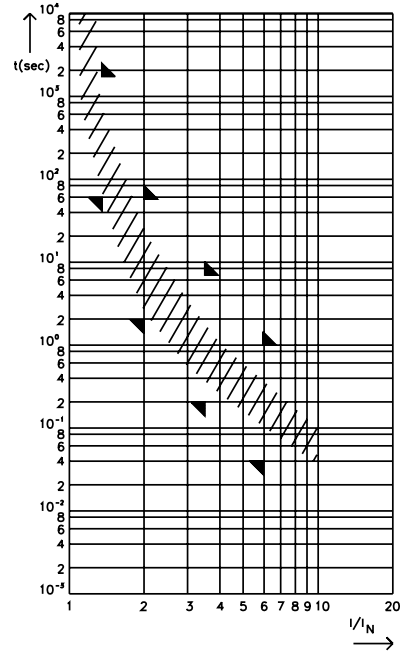

FI = 1.33 (max. operating current: 0.75 x I_{rat} at 23°C)