

RoHS  **219XA Series, 5x20mm, Time-Lag (Slo-Blo®) Fuse**











Description

5x20mm time-Lag glass body cartridge fuse designed to IEC specification

Features

- Designed to International (IEC) Standards for use globally
- Meets the IEC 60127-2, Sheet 6 specification for time-Lag fuses
- Available in cartridge and axial lead form
- RoHS compliant and lead-free

Agency Approvals

Agency	Agency File Number	Ampere Range
	Cartridge Certifications: NBK220604-E10480A NBK230604-E10480A Leaded Certifications: NBK220604-E10480B NBK230604-E10480B	1A – 5A 6.3A 1A – 5A 6.3A
	Certifications: 2004010207110266 2003010207079982	125mA – 800mA 1A – 6.3A
	Recognised File: E10480 Guide: JDYX2	40mA – 6.3A
	File and Acc. Class: 029862_0_000	125mA – 6.3A
	License: KM41462	
	File: 604904/604924 402708 310144	40mA – 100mA 125mA – 800mA 1A – 6.3A
	License: 40016080	125mA – 6.3A
		40mA – 6.3A

Applications

Used as supplementary protection in appliance or utilization equipment to provide individual protection for components or internal circuits.

Electrical Characteristics for Series

% of Ampere Rating	Ampere Rating	Opening Time
150%	40mA – 100mA	1 hours, Minimum
	125mA – 6.3A	1 hours, Minimum
210%	40mA – 100mA	2 minutes, Maximum
	125mA – 6.3A	2 minutes, Maximum
275%	40mA – 100mA	0.2 sec., Min; 10 sec. Max
	125mA – 6.3A	0.6 sec., Min; 10 sec. Max
400%	40mA – 100mA	0.04 sec., Min; 3 sec. Max
	125mA – 6.3A	.15 sec., Min; 3 sec. Max
1000%	40mA – 100mA	.01 sec., Min; 0.3 sec. Max
	125mA – 6.3A	.02 sec., Min; 0.3 sec. Max

219XA Series

Electrical Characteristic Specifications by Item

Amp Code	Amp Rating (A)	Voltage Rating (V)	Interrupting Rating	Nominal Cold Resistance (Ohms)	Nominal Melting I ² t (A ² sec)	Nominal Voltage Drop at Rated Current (mV)	Nominal Power Dissipation at Rated Current (W)	Agency Approvals							
								PS E	RU	SP	S	V	CCC	CE	DVE
.040	0.040	250	150A @ 250VAC	31.8620	0.01100	4000	1.6		x		x			x	
.050	0.050	250		21.2920	0.01700	3500	1.6		x		x			x	
.063	0.063	250		14.2685	0.02850	3000	1.6		x		x			x	
.100	0.100	250		6.0180	0.07900	2500	1.6		x		x			x	
.125	0.125	250		4.2000	0.13000	2000	1.6		x	x	x	x	x	x	x
.160	0.160	250		2.5500	0.31000	1900	1.6		x	x	x	x	x	x	x
.200	0.200	250		1.6000	0.32000	1500	1.6		x	x	x	x	x	x	x
.250	0.250	250		1.0495	0.54000	1300	1.6		x	x	x	x	x	x	x
.315	0.315	250		0.8475	1.23000	1100	1.6		x	x	x	x	x	x	x
.400	0.400	250		0.5350	1.40000	1000	1.6		x	x	x	x	x	x	x
.500	0.500	250		0.3700	3.00000	900	1.6		x	x	x	x	x	x	x
.630	0.630	250		0.2750	4.82000	300	1.6		x	x	x	x	x	x	x
.800	0.800	250		0.1635	9.35000	250	1.6		x	x	x	x	x	x	x
001.	1.00	250		0.1165	19.20000	150	1.6	x	x	x	x	x	x	x	x
1.25	1.25	250		0.0817	27.15000	150	1.6	x	x	x	x	x	x	x	x
01.6	1.60	250		0.0551	44.20000	150	1.6	x	x	x	x	x	x	x	x
002.	2.00	250		0.0452	92.70500	150	1.6	x	x	x	x	x	x	x	x
02.5	2.50	250		0.0305	138.00000	120	1.6	x	x	x	x	x	x	x	x
3.15	3.15	250		0.0231	202.00000	100	1.6	x	x	x	x	x	x	x	x
004.	4.00	250		0.0158	330.00000	100	1.6	x	x	x	x	x	x	x	x
005.	5.00	250	0.0117	544.00000	100	1.6	x	x	x	x	x	x	x	x	
06.3	6.3	250	0.0117	1093.03500	100	1.6	x	x	x	x	x	x	x	x	

Temperature Derating Curve

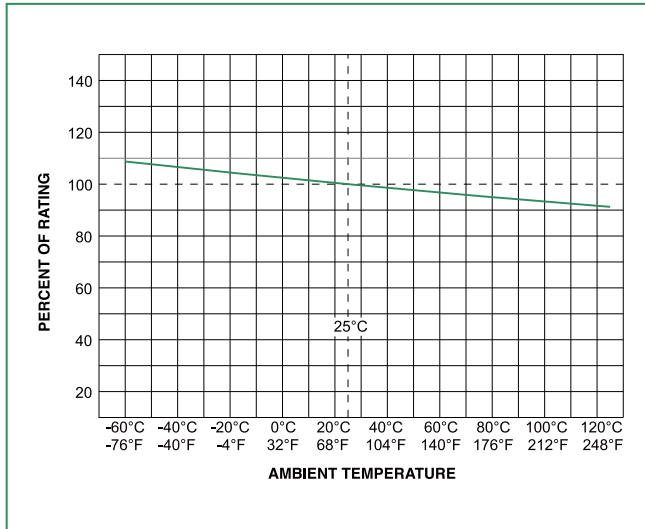

Average Time Current Curves

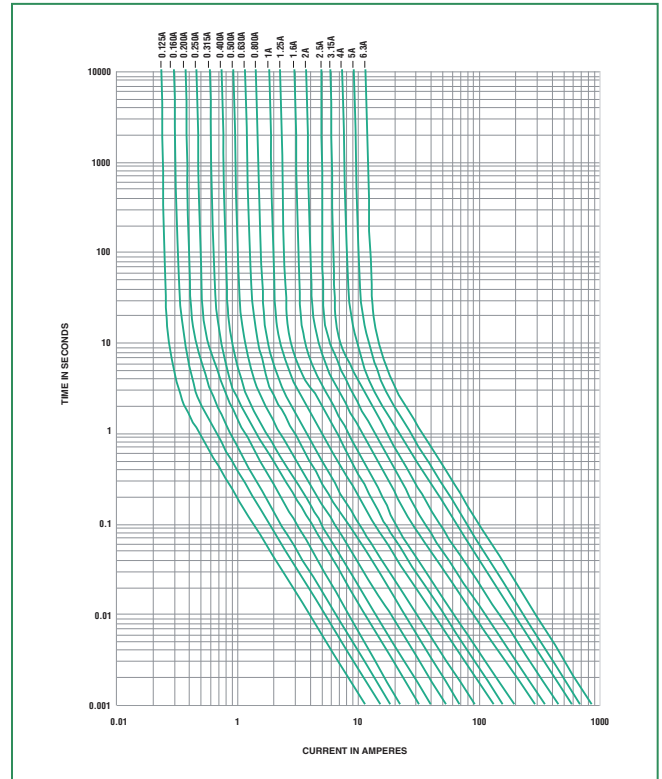

Soldering Parameters - Wave Soldering

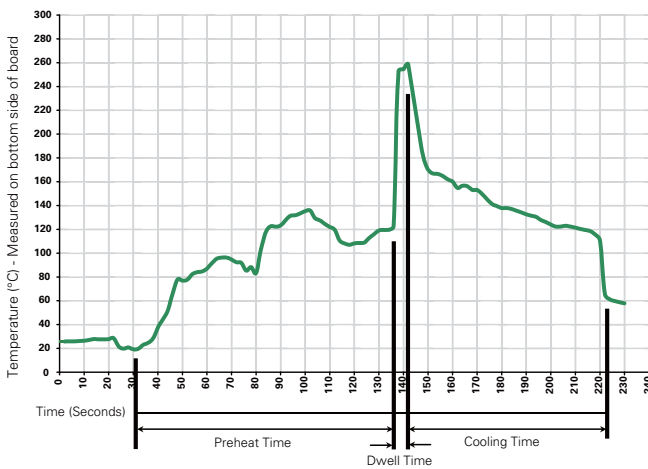

Recommended Process Parameters:

Wave Parameter	Lead-Free Recommendation
Preheat: (Depends on Flux Activation Temperature) (Typical Industry Recommendation)	
Temperature Minimum:	100° C
Temperature Maximum:	150° C
Preheat Time:	60-180 seconds
Solder Pot Temperature:	260° C Maximum
Solder Dwell Time:	2-5 seconds

Recommended Hand-Solder Parameters:

Solder Iron Temperature: 350° C +/- 5° C
Heating Time: 5 seconds max.

Note: These devices are not recommended for IR or Convection Reflow process.

219XA Series

Product Characteristics

Materials	Body: Glass Cap: Nickel Plated Brass Leads: Tin Plated Copper
Terminal Strength	MIL-STD-202G, Method 211A. Test Condition A
Solderability	Reference IEC 60127 Second Edition 2003-01 Annex A
Product Marking	Cap 1: Brand logo, current and voltage rating Cap 2: Agency approval markings Series
Packaging	Available in Bulk (M=1000 pcs/pkg) or on Tape/Reel (MRET1=1000 pcs/reel)

Operating Temperature	-55°C to +125°C
Shock	MIL-STD-202G, Method 107G, Test Condition B: (5 cycles -65°C to +125°C)
Vibration	MIL-STD-202G, Method 201A
Humidity	MIL-STD-202G, Method 103B, Test Condition A high RH (95%) and elevated temperature (40°C) for 240 hours.
Salt Spray	MIL-STD-202F Method 101D, Test Condition B

Dimensions

0219 000XAP

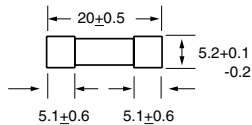

0219000XAEP

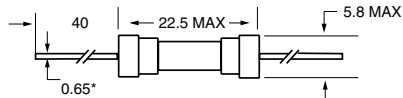

All dimensions in mm

Notes:
* Ratings above 6.3A have 0.8 mm dia lead

Part Numbering System

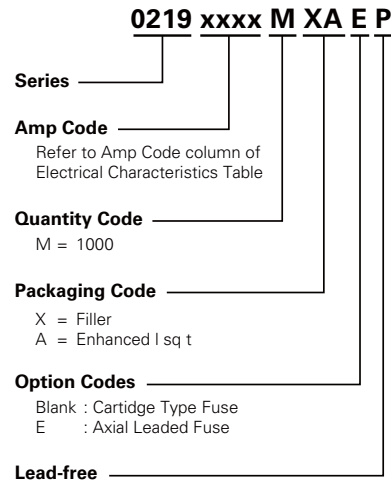

Packaging

Packaging Option	Packaging Specification	Quantity	Quantity & Packaging Code	Taping Width
219XA Series				
Bulk	N/A	1000	MXA	N/A
Bulk	N/A	1000	MXAE	N/A
Reel and Tape	EIA 296-E	1000	MRAET1	T1=52mm (2.062")
Bulk	N/A	1000	MXG	N/A